

# ELECTRONIC INDUSTRIES

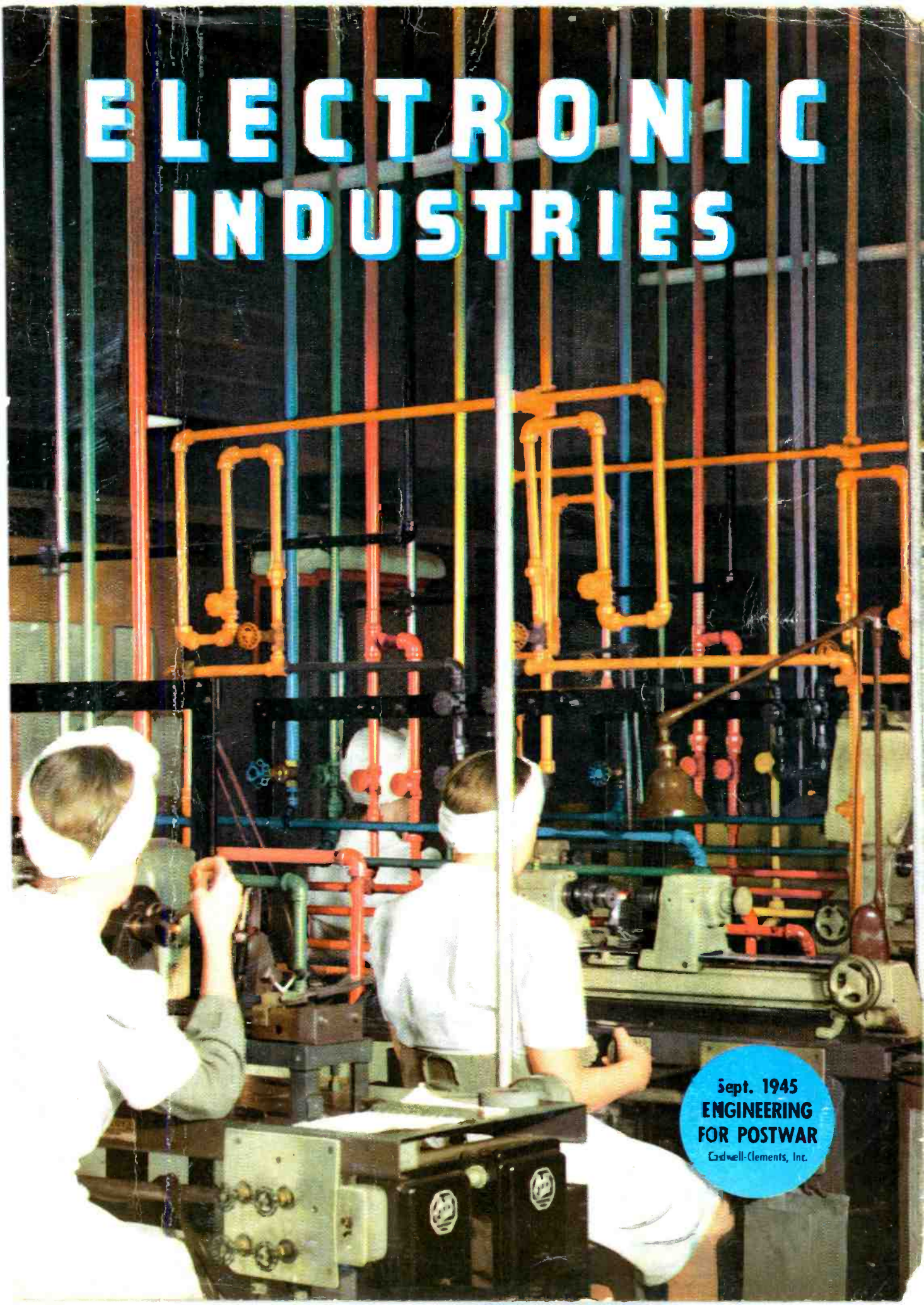

Sept. 1945  
**ENGINEERING  
FOR POSTWAR**  
Caldwell-Clements, Inc.

P.R. MALLORY & CO. Inc.  
**MALLORY**

Hermetically-Sealed

**VIBRATORS**

Improve

**VIBRAPACK\***

Performance

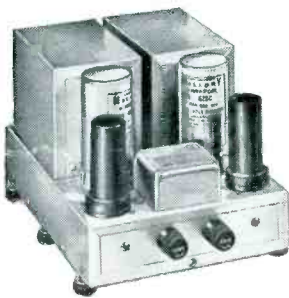
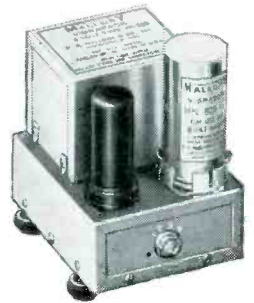
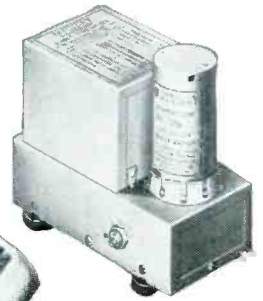
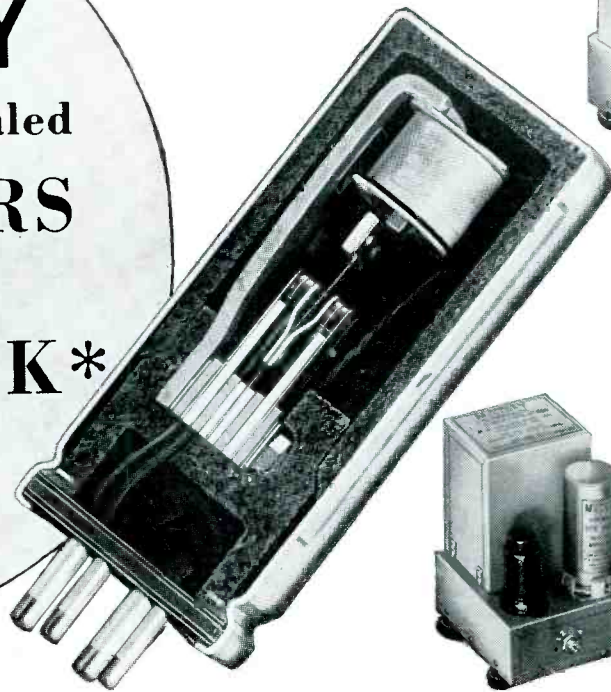

**D**EVELOPED originally to meet exacting military requirements for aircraft communications in the sub-stratosphere, hermetically-sealed Mallory Vibrators are now standard equipment with every standard stock Vibrapack.

Hermetically-sealed vibrators assure longer life and greater dependability, because moisture and corrosive fumes are sealed out, and ionization breakdowns are prevented.

When you need a portable power supply to provide high voltage from a low voltage DC source, specify Vibrapacks. Other features include:

**Nominal input voltages of 6, 12 and 32 volts DC.**

**Nominal output voltages from 125 to 400.**

**Models available with switch for four output voltages in approximate 25-volt steps.**

**Heavy-duty models with 60-watt capacity.**

You can easily obtain Mallory Vibrators and Vibrapacks from your nearest Mallory Distributor. Ask him for free descriptive literature, or write us today.



*Inquiries are invited from manufacturers for Vibrators and Vibrapacks for use in original equipment.*

**P. R. MALLORY & CO., Inc., INDIANAPOLIS 6, INDIANA**

\*Reg. U. S. Pat. Off. for vibrator power supplies

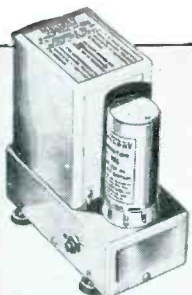

P.R. MALLORY & CO. Inc.  
**MALLORY**

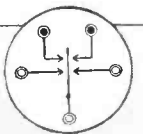
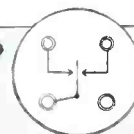
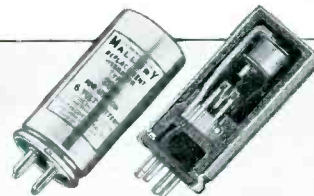

**VIBRATORS**

**and VIBRATOR POWER SUPPLIES**

# ELECTRONIC INDUSTRIES

Including INDUSTRIAL ELECTRONICS

★ IN THIS ISSUE                      SEPTEMBER, 1945                      ★

FRONT COVER—Producing Klystron Tubes .....	4
POSTWAR ENGINEERING .....	74
NAVY'S FLOATING ELECTRONIC LABORATORY .....	76
ATOMIC FISSION WILL HAVE PROFOUND EFFECT—Dr. Harlan T. Stetson..	77
SYNCHRO CONTROLS FOR METERS AND SERVOS—Raymond Goertz .....	78
FM POWER CONVERTER—Frank A. Gunther .....	84
CRASH FAILS TO STOP NBC TELE STATION .....	86
TELEVISION vs. FOLIAGE .....	88
NOMOGRAPH FOR Q METER .....	90
GLOSSARY OF COMMON RADAR EXPRESSIONS .....	92
AMERICANIZED-BRITISH RADAR TUBE .....	92
U. S.-BRITISH RADAR REPORTS ISSUED .....	93
FM-TELE STANDARDS .....	94
WESTINGHOUSE PROPOSES FLYING TELE-FM STATIONS .....	94
RADIO DOOR ACTUATOR—R. G. Rowe .....	96
PHASE SHIFT EFFECT ON AMPLIFIERS—Goswin Schaffstein .....	98
THRU THE LABORATORY KEYHOLE .....	101
PHONO HEAD BALANCE—Norman L. Chalfin .....	102
GAGING BY THE BLIND .....	104
\$1000 EDITORIAL AWARD .....	105
TUBES ON THE JOB .....	106
SURVEY OF WIDE READING .....	110
NEW PATENTS ISSUED .....	112
PROJECTION C-R-O TUBE—Rudolf Feldt .....	113
RADAR DEVELOPED ELECTRONIC NAVIGATOR .....	218
News of the Industry .....	114
Television Today .....	126
What's New .....	116
Personnel .....	202
Washington News .....	122
New Books .....	210

New Bulletins ..... 212

ORESTES H. CALDWELL, Editor                      M. CLEMENTS, Publisher

**EDITORIAL STAFF**—Ralph R. Batcher, consulting editor; Stanley P. McMinn, managing editor; William Moulic, electronic theory and design; H. Gregory Shea, industrial engineering applications; Josepha Zentner, Ph.D., patents and foreign reviews; H. L. M. Capron, engineering management relations; E. T. Bennett, editorial records; Charles Dreyer, art director; Carl Buhner, circuit diagrams; Roland C. Davies, 1290 National Press Building, Washington, D. C., Washington editor; Arthur H. Halloran, 1020 Union St., San Francisco, west coast editor.

**READER SERVICE**—J. Coslin, H. Mirtel; data research, H. Kulik.

**CIRCULATION**—B. V. Spinetta, circulation director; Subscriptions; list compilation: B. Gollub, M. Groening, B. Ruchaisky.

**BUSINESS**—M. H. Newton, business manager; John Samborn, eastern manager; Richard Fitzpatrick, western manager; O. H. Sutter, New England manager; Lee Robinson, district manager; Ben Morris, research; J. E. Cochran, make-up; E. P. Butler; W. W. Swigert, credit manager; W. Kenneth Reynolds, D. Williams, E. Callahan.

**BRANCH OFFICES**—Chicago 6, R. Y. Fitzpatrick, 201 N. Wells St., RAN. 9225; Cleveland 14, Dudley B. Trott, Citizens Bldg., 850 Euclid Ave., Main 8270; Los Angeles 14, Robert W. Walker, Walker & Minton, 403 W. 8th St., VAndike 9348; San Francisco 4, Eli C. Minton, Walker & Minton, 68 Post St., SUTTER 5568.

**CALDWELL-CLEMENTS, INC. — TEL. PLAZA 3-1340 — 480 LEXINGTON AVENUE, NEW YORK 17, N. Y.**

Electronic Industries, September, 1945. Vol. IV, No. 9. Regular price per copy 35 cents. Published monthly by Caldwell-Clements, Inc., 480 Lexington Avenue, New York 17, N. Y. M. Clements, President; Orestes H. Caldwell, Treasurer; M. B. Clements, Assistant Secretary. Subscriptions: United States and Possessions, Mexico, Central and South American countries, \$3.00 for one year; \$5.00 for two years; \$6.50 for three years. Canada, \$3.50 per year; \$5.50 for two years; \$7.15 for three years. All other countries \$5.00 a year. Entered as Second Class Matter, September 20, 1943, at the Post Office at New York, N. Y., under the act of March 2, 1879. Copyright by Caldwell-Clements, Inc., 1945. Printed in U. S. A.

# THE AMPEREXTRA FACTOR in ELECTRO-MEDICAL EQUIPMENT

Long experience . . . complete cooperation in equipment design and operational problems—these comprise the AMPEREXTRA FACTOR in electronic tubes for diathermy and other electro-medical applications. AMPEREX was among the first to produce completely successful tubes for this field, and our designs have aided in its growth and expansion. Some 70% of the electro-medical industry has recognized our leadership and is now on our list of good customers.



## GOOD INITIAL DESIGN . . .

. . . is largely responsible for the high performance of Amperex air and water cooled tubes. Other factors are dependable materials and their rigid inspection, good mechanical construction, and absolute freedom from efficiency-impairing gases.

*Amperex Type HF-100 Transmitting Tube. Filament Voltage, 10-10.5 volts. Filament current, 2.5 amperes. Amplification factor, 23. Grid to plate transconductance at 100 ma., 4200. Direct interelectrode capacitance: Grid to plate, 4.5 $\mu$ f; grid to filament, 3.5 $\mu$ f; plate to filament, 1.4 $\mu$ f. \$12.50, list price.*



*Amperex Type HF-200 Transmitting Tube. Filament voltage, 10-11 volts. Filament current, 4 amperes. Amplification factor, 18. Grid to plate transconductance at 150 ma., 5000 micromhos. Direct interelectrode capacitances: grid to plate, 5.8 $\mu$ f; grid to filament, 5.2 $\mu$ f; plate to filament, 1.2 $\mu$ f. List price, \$24.50.*



*Amperex Type 211-H Transmitting Tube. Filament voltage, 10-10.5 volts. Filament current, 3.25 amperes. Amplification factor, 12.5. Grid to plate transconductance at 100 ma., 4300 micromhos. Direct interelectrode capacitances: grid to plate, 7.2 $\mu$ f; grid to filament, 5.3 $\mu$ f; plate to filament, 1.9 $\mu$ f. List, \$17.50.*



## AMPEREX TUBES . . .

. . . for electro-medical equipment include more than 30 different types, ranging from 25 watt plate dissipation to 300 watts. Many of them are now on the shelves of leading radio equipment distributors.

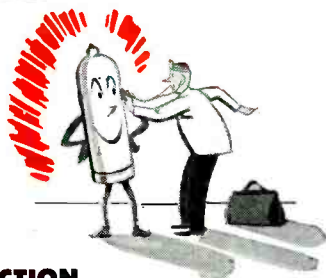

## PROTECTION AGAINST UNTIMELY DEATH . . .

. . . is provided by our Special Application Engineering Department where tubes are tried under actual operating conditions and operational data obtained for their most efficient and lasting use.

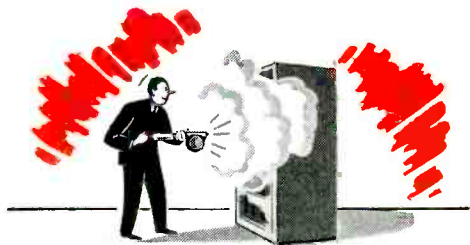

## HELPING YOU GET THE "BUGS" OUT

. . . we of Amperex make nothing else but tubes. In the electro-medical field, we are especially well equipped to help you iron out the "bugs" in your present equipment, and to aid you in any new developments as well.

## AMPEREX

. . . the high  
performance tube

Our Special Application Engineering Department will gladly work with you on present or post-war assignments.



# AMPEREX ELECTRONIC CORPORATION

25 Washington St., Brooklyn 1, N. Y., Export Division: 13 E. 40th St., New York 16, N. Y., Cables: "Arlab"  
Canadian Distributor: Rogers Majestic Ltd. • 622 Fleet Street West, Toronto

THIS IS NO TIME TO RELAX — KEEP BUYING WAR BONDS

ELECTRONIC INDUSTRIES • September, 1945

# Quality-checked

EVERY STEP OF THE WAY

Non-inductive winding  
of pure aluminum foil and  
finest capacitor tissue

Precision-wound section  
vacuum-impregnated with  
mineral oil

Micanite plates  
protect winding against  
damage

Tinned copper leads  
welded into heavy  
terminals

Secure clamping  
gives low-resistance contact  
with foil layers

Necprene seal  
mold-cured for permanent  
sealing of leads and case

Pre-formed blanks  
of mica-filled phenolic  
assure uniformity in molding

Glycyl lacquer  
applied after molding affords  
overall moisture protection

Type DP—a dependable unit for all-purpose applications; quality-checked by continuous production sampling from raw material to finished product. Facilities for producing these units in unlimited volume assure adequate supply at all times.

Capacitances—1000 to 50000 mmfd.; working voltages—120 to 800 d-c; sizes—CN20 and CN35; shunt resistance—50000 megohms at 25°C; P.F. as low as 0.004 at 1000 cycles.



FIELD OFFICES IN NEW YORK CITY • CHICAGO • DETROIT • GLENDALE, CALIFORNIA

**POWER SUPPLY RA-57A**

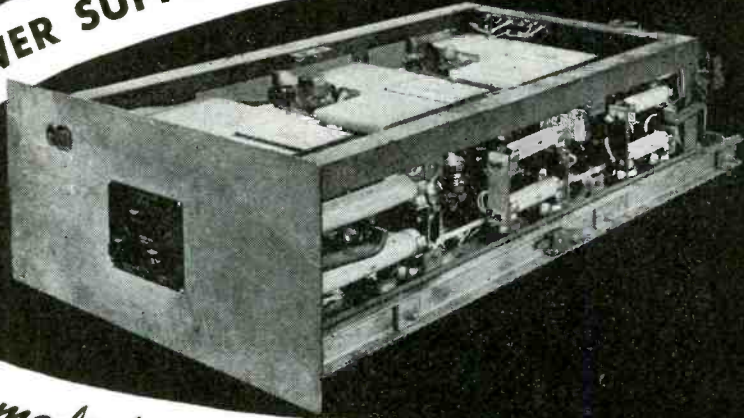

*Immediate Delivery! No Priority!*

This unit contains three regulated power supplies employing the popular two stage amplifier circuit which assures excellent regulation and freedom from hum. Power supply #1 has a variable voltage range from 750 to 900 volts DC at a maximum load of 125 ma. Line voltage may drop as low as 85 volts at medium load and 100 volts at maximum load, throughout the voltage range from 750 VDC to 900 VDC without appreciable change in output voltage. The ripple content within these voltage ranges is less than 5 millivolts from no load to full load. This supply may be operated with either the negative or positive side of the output grounded so that it can be used to furnish plate voltage or grid bias.

Power Supplies #2 and #3 are identical, having a variable voltage range from 230 VDC to 330 VDC at a maximum load of 400 ma. Line voltage may drop as low as 80 volts at 200 ma. and 100 volts at a maximum load of 400 ma., without appreciable output voltage change. Ripple content is less than 5 millivolts at all loads and voltages. The line voltage may rise to 130 volts without changing the ripple content or output voltage.

These supplies have the negative side permanently grounded and they can be reversed to use them as bias supplies. Voltage variation is accomplished by adjustment of the three potentiometers on the front panel. A terminal strip is provided on the rear panel for the output voltages and for the 115 volt 60 cycle input voltages. The 115 volt input voltage to the three rectifier filament transformers are connected in parallel. Each transformer is fused separately. The plate transformer of Power Supply #1 is terminated separately. The plate transformers of Supplies #2 and #3 are connected in parallel internally. The plate circuits are also independently fused. It is necessary to furnish external switches for the various primary circuits to place the Supply in operation.

**Tubes Used in the High Voltage Power Supply:**

- 2 — 866 Rectifier Tubes
- 1 — VR105 Regulator Tube
- 2 — 6L6 Series Tubes
- 1 — VR150 Regulator Tube
- 2 — 6SF5 Amplifiers

**Tubes Used in Each Low Voltage Supply:**

- 2 — 866 Rectifier Tubes
- 1 — VR105 Rectifier Tube
- 6 — 6L6 Series Tubes
- 1 — VR150 Rectifier Tube
- 2 — 6SF5 Amplifiers

*This unit is supplied in a Chassis Size 39" deep, 17 1/4" wide back of panel. Panel Size is 21" wide and 10" high. Net weight is 295 lbs.*

*These units are supplied complete with tubes, instruction manual and circuit diagram, and are covered by the normal 90 day manufacturer's guarantee.*

At the Nassau plant of the Sperry Gyroscope Co., Great Neck, L. I., women employes work at glass lathes while sealing glass to metal parts during one of the important steps in the manufacture of Sperry Klystron tubes that today are used in various war instruments and following the war will find wide application in the field of microwave broadcast and reception.

The pattern of colors above the heads of the workers is made by pipes which convey gases used at various stages in the manufacturing process. Each color identifies a different gas.

\* \* \*

**Allocations Chart  
Production Details**

There has been so much laudatory comment on the four-color Allocations Chart which was mailed to subscribers of Electronic Industries as a supplement with the August issue, that some further facts concerning its production may be of interest. Preliminary skeleton drawings had been prepared in advance and immediately after allocations were approved by FCC the work of placing them in their proper spots in the spectrum was started. The entire art job was done by EI's Art Director Charles Dreyer and required approximately 100 hours of toil. Before the work of determining the color scheme to be used was started, the final black and white drawings were checked twice, once by an outside expert on allocations matters and a second time by an engineer of FCC who put in four hours on this job alone. The color scheme represents a combination of black with the three primary colors, red, yellow and blue, plus the over-printing of eight standard Ben Day screens to form the 39 colors and patterns used to identify the various services provided for in the allocations. Production of the four sets of printing plates required about 10 days.

**Million-Watt Voice**

Even the Crosley 500-kw transmitter (WLW), now awaiting FCC decision regarding its disposal to other interests, may not seem so big in the near future. There is a million-watt transmitter all engineered and, it is said, sold. Furthermore, this giant is to be installed "somewhere in continental North America." Location may be just across one or another of the borders.

**COMMUNICATION MEASUREMENTS LABORATORY**

Agent of Defense Supplies Corporation

Handling All Types of Electronic Equipment

120 GREENWICH STREET

NEW YORK 6, N. Y.

# When replacing rectifier PHANOTRONS choose G-E tubes for efficiency



## TYPE FG-32. \$9.

Two-electrode, mercury-vapor-phanotron tube for use as a half-wave, medium-voltage rectifier. Cathode indirectly heated—voltage 5 v, current 4.5 amp. Anode peak voltage 1,200 v, peak current 15 amp average current 2.5 amp. Temperature range, condense mercury, 40 to 80 C. Overall height of tube 7", diameter 3". Upon request, you will gladly be sent detailed characteristics and performance ratings of the FG-32, which is one of 9 G-E phanotrons that cover the full range of application of this type of tube.

**S**MOOTH and even flow of d-c current from a multiphase or other phanotron tube rectifier, depends on the proper, uniform functioning of every tube in the bank. To assure a steady supply of power, use G-E phanotrons—for their current-carrying capacity, dependability, and the way they team up for solid group performance.

● Type FG-32, shown above, is one of the popular tubes of this type, suited to medium-voltage circuits. Superior G-E manufacturing and testing methods give uniform electrical characteristics, meaning that every Type FG-32 in a bank functions alike—and efficiently!

● Advanced design is typified by the shield between cathode and cathode stem, protecting the stem from heat-distortion. Other special features that make for stable operation are the 3-point suspension of the cathode, giving rigidity and strength, and the torqued cathode base and anode cap to safeguard against connections loosening in service.

● See your nearest G-E office or distributor for further information about Type FG-32 and other tough, service-proved phanotrons in G.E.'s complete line. Or write *Electronics Department, General Electric, Schenectady 5, N. Y.*

There are 265 main supply outlets for G-E Electronic Tubes, backed up by centrally located stocks in 26 large cities from coast to coast.

# GENERAL ELECTRIC

162-D17-8850

TRANSMITTING, RECEIVING, INDUSTRIAL, SPECIAL PURPOSE TUBES ★ VACUUM SWITCHES AND CAPACITORS  
ELECTRONIC INDUSTRIES ● September, 1945

# Micronics



**D**esigning UHF and SHF equipment is in large part a matter of electromechanical precision. Our engineers aptly call it *micronics*.<sup>\*</sup> Micronics is an art at which we are adept. A part of our know-how stems from long experience in the design and manufacture of precision-machined hydraulic controls and actuators for military and commercial aircraft. It comes equally from the confidential basic design work our engineers have done in the field of micro-waves. And part comes from a pre-war background of experience in producing radio communication systems for a number of the country's major airlines. **Aireon's** micronic exactitude in all things electronic is a practice your engineers will appreciate—an aptitude our plants can translate into your precise wants. Your engineers and ours should talk it over.

<sup>\*</sup>"Micronic" is a registered trade mark of Aireon Mfg. Corp.

# Aireon

**MANUFACTURING CORPORATION**

Formerly AIRCRAFT ACCESSORIES CORPORATION

**Radio and Electronics • Engineered Power Controls**

**NEW YORK • CHICAGO • KANSAS CITY • BURBANK**

ELECTRONIC INDUSTRIES • September, 1945



**New!**

# Free-Cutting Copper Rod

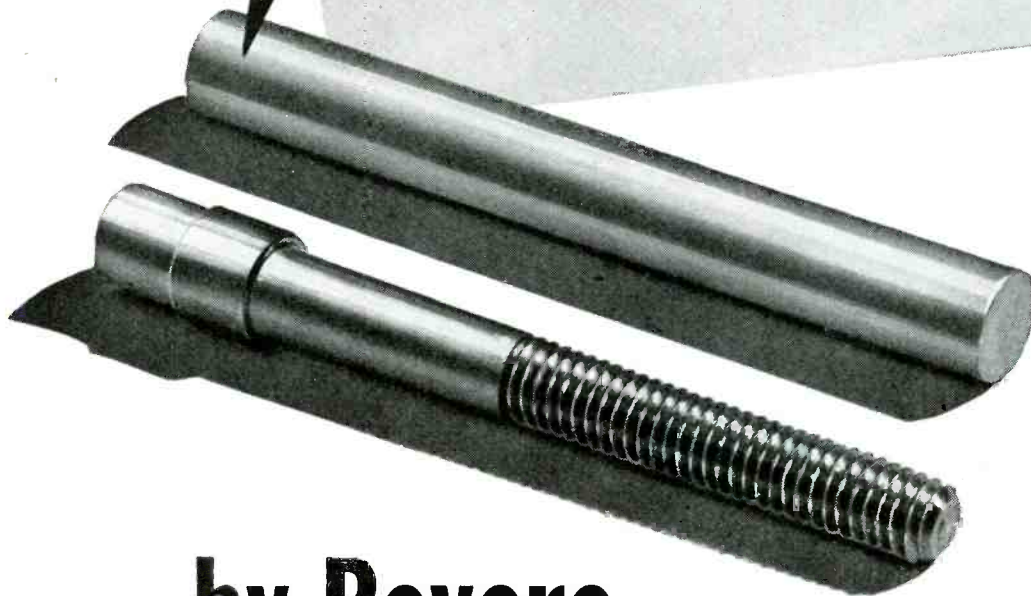

## ...by Revere increases electronic production

To meet the demands of the electronic and electrical industries, Revere now offers Revere Free-Cutting Copper Rod.

This is oxygen-free, high conductivity copper containing a small amount of tellurium. This, plus special processing in the Revere mills, greatly increases the speed with which the metal can be machined, makes it possible to hold closer tolerances, improves the finish of completed parts, lessens rejects, cuts costs.

Revere Free-Cutting Copper Rod already has proved invaluable for the precision manufacture of certain interior vacuum tube parts that must be made to exceptional standards. However, it does not make a vacuum-tight seal with glass, and OFHC copper or other metals and alloys must continue to be used for that purpose. The rod is available in sizes up to 2" and in all the usual shapes.

The Revere Technical Advisory Service has worked out solutions of a number of difficulties encountered with the use of copper and its alloys in electronics. May we collaborate on your problems?

*Listen to The Human Adventure on the Mutual Network every Wednesday evening, 10 to 10:30 p.m., EWT*

#### CUSTOMERS REPORT:

"This material seems to machine much better than our previous hard copper bar; it cuts off smoothly, takes a very nice thread, and does not clog the die." (Electrical parts.)

"Increased feed from 1½" to 6" per minute and do five at one time instead of two." (Switch parts.)

"Spindle speed increased from 924 to 1161 RPM and feed from .0065" to .0105" per spindle revolution. This resulted in a decrease in the time required to produce the part from .0063 hours to .0036 hours. Material was capable of faster machine speeds but machine was turning over at its maximum. Chips cleared tools freely, operator did not have to remove by hand." (Disconnect studs.)

# REVERE

**COPPER AND BRASS INCORPORATED**

*Founded by Paul Revere in 1801*

Executive Offices: 230 Park Avenue, New York 17, N. Y.

Mills: Baltimore, Md.; Chicago, Ill.; Detroit, Mich.; New Bedford, Mass.; Rome, N. Y. — Sales Offices in principal cities, distributors everywhere

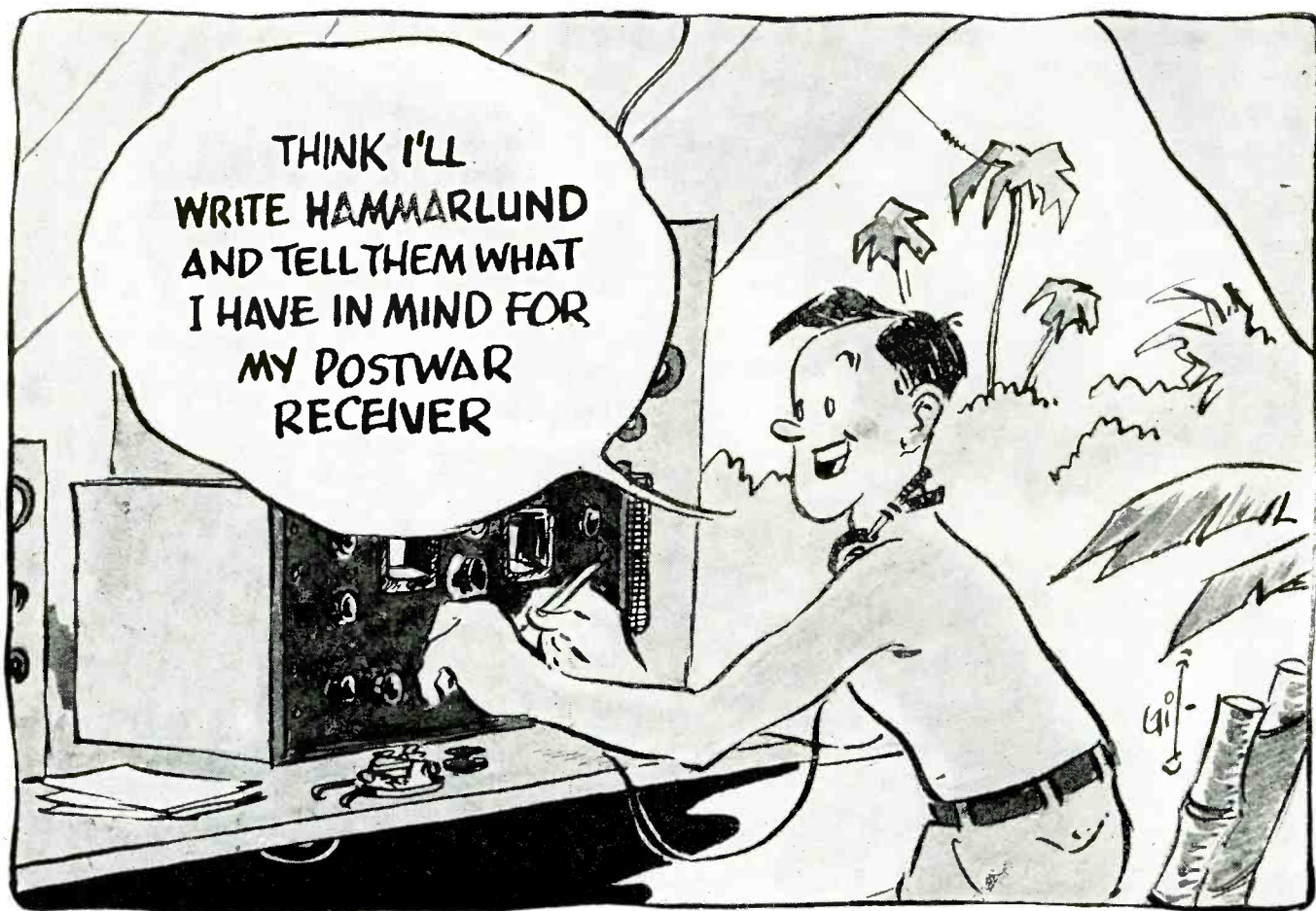

# WHAT DO YOU WANT?

WRITE  
NOW!

THE SUPER-PRO and HQ-120-X were, and still are, tops in the Ham field and after the war we'll have a complete line of receivers to meet every requirement. What we want to know is what you'd like . . . in the way of appearance, accessories, special features. Let us know what you have in mind. Suggestions (good or bad) will be welcome and will help us to give you the best . . . just the way you want it.

Send your suggestions to "Postwar Development"  
DESK 16

# HAMMARLUND

THE HAMMARLUND MFG. CO., INC., 460 W. 34<sup>TH</sup> ST., N. Y. C.

MANUFACTURERS OF PRECISION COMMUNICATIONS EQUIPMENT

ELECTRONIC INDUSTRIES • September, 1945

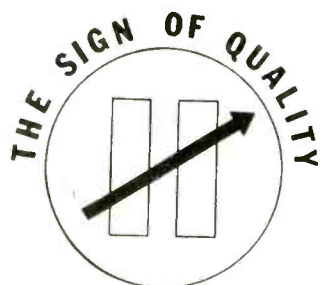

ESTABLISHED 1910

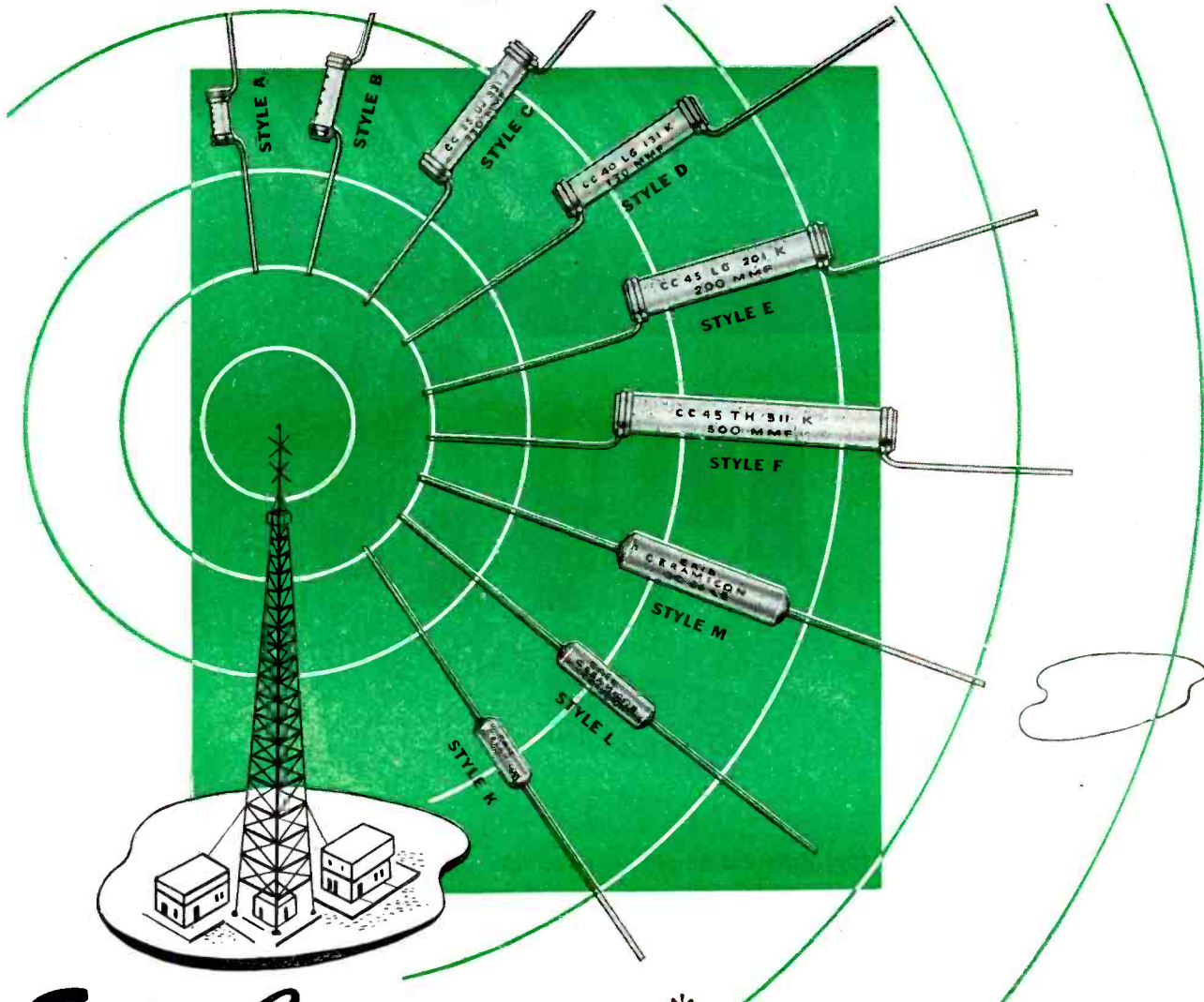

# Erie Ceramicons\* MAINTAIN SUPREMACY IN FIELD OF COMMUNICATIONS FOR TEMPERATURE COMPENSATING AND GENERAL PURPOSE CONDENSERS

Erie Ceramicons are not a war product. These silvered ceramic condensers were developed ten years ago to provide accurate compensation for temperature drift in receivers. The war has furnished further and convincing evidence of their superiority, for millions of Ceramicons have been subjected to punishment such as peacetime applications seldom duplicate. The war also has proven the adaptability of Ceramicons for use as general purpose condensers.

Erie Ceramicons are ideal coupling condensers, particularly in plate-to-grid installations, where high insulation resistance is essential; and for general R.F. by-pass applications. Their superiority is generally recognized in numerous applications in the field of civilian communications and domestic receiver sets.

Ceramicons may be selected from any one of 10 standard temperature coefficients, ranging from P100 to N750, as well as of the Hi-K type. Table of capacity ranges for standard Erie Resistor styles is shown at right.

Samples of Erie Ceramicons for your general purpose applications will be gladly furnished on request.

ERIE STYLE	MAXIMUM CAPACITY		
	TEMPERATURE CHARACTERISTIC		
	O	N750	HI-K
A or K	0.5 to 18	1 to 51	52 to 600
B or L	18 to 36	52 to 110	610 to 1,500
C or M	37 to 120	111 to 360	1,600 to 5,000
D	121 to 175	361 to 510	5,100 to 7,700
E	176 to 285	511 to 820	7,800 to 11,500
F	286 to 375	821 to 1100	12,000 to 16,000

\* CERAMICON IS THE REGISTERED TRADE NAME OF SILVERED CERAMIC DIELECTRIC CONDENSERS MADE BY ERIE RESISTOR CORPORATION.



*Electronics Division*  
**ERIE RESISTOR CORP., ERIE, PA.**  
LONDON, ENGLAND • • TORONTO, CANADA



# 108 SERIES

# Amplifiers

WITH MOUNTING ACCESSORIES



**TYPE 108-B** two-stage Amplifier provides transformer input impedances for either 30 or 250 ohms with nominal output impedance 500 or 8 ohms. Variable gain 65/105 db. with electronic volume control. Frequency response better than  $\pm 1$  db. 30/16,000 c.p.s. Power output +43 V.U. (20 watts) with less than 5% RMS harmonic content. Noise level full gain 56 db. below full output.

**THE 108 SERIES** consist of four different amplifiers available simply by changing one or two small input panels on the master chassis. Except for these input panels all amplifiers have the same transmission characteristics. Input impedance, gain and noise level depending on types listed below.

These units are designed for the highest type audio service having gain-frequency characteristics better than  $\pm 1$  db. 30/16,000 c.p.s. Power output +43 V.U. (20 watts) with less than 5% RMS harmonic content.

**TYPE 108-A** two-stage Amplifier provides transformer input for either 600 ohm or bridging. 600 ohm input fixed gain 61 db. Bridging input variable gain 6/46 db. Noise level 68 db. below full output.

Bridging input variable gain 2/42 db. Channel 2—high gain 30/250 ohm input variable gain 62/102 db. with electronic volume control. Noise level 56 db. below full output.

**TYPE 108-B** as illustrated and described above.

**TYPE 108-C** combines the input channels of the 108-A and 108-B Amplifiers. Channel 1—600 ohm input variable gain 20/60 db.

**TYPE 108-D** two-channel each 30/250 ohm input. Either channel variable gain 62/102 db. with electronic volume control. Noise level 56 db. below full output.

## MOUNTING ACCESSORIES

**TYPE 202-A** Wall Mounting Cabinet permits universal installation of 108 Series Amplifiers to any flat surface. Well ventilated and designed for maximum accessibility, servicing and convenience of installation. Standard aluminum gray finish.

**TYPE 9-A** Modification Group permits 108 Series Amplifiers to mount on standard 19" telephone relay racks. Occupies 7" rack space. Allows servicing from front of rack. Standard aluminum gray finish.

# The Langevin Company

INCORPORATED

SOUND REINFORCEMENT AND REPRODUCTION ENGINEERING

NEW YORK  
37 W. 65 St., 23

SAN FRANCISCO  
1050 Howard St., 3

LOS ANGELES  
1000 N. Seward St., 38

# YOUR CHECK LIST OF NEW IRC PRODUCTS

To a line of resistors already broader than that of any other manufacturer in the entire resistor industry, IRC has, in the last few months, announced several new and important contributions. Among the newer developments having wide-spread application in the electronics field are the components here briefly

reviewed. All of these products are available in reasonable quantities except the Type BTR Resistor, which is still wholly allocated to a special war project. However, samples of this unit are available and will be gladly sent for test or experimental purposes. Your inquiries will receive prompt and welcome attention.

## TYPE PRT POWER RHEOSTAT

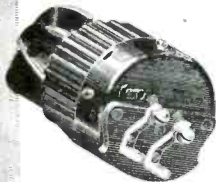

Rugged yet light in weight and of neat appearance the PRT conforms fully with AN3155 specs. Has heavy screw type terminals at rear of enclosed all-metal housing. Available in 25 and 50 watt models.

## TYPE BTA 1 WATT METALLIZED INSULATED RESISTOR



Pencil-thin, less than  $\frac{3}{4}$ " in length and conservatively rated at one watt the BTA is a quality resistor throughout and meets RC30 specs. Low in operating temperature it has proportionately high wattage dissipation.

## TYPE BTR $\frac{1}{3}$ WATT METALLIZED INSULATED RESISTOR



Scarcely bigger than a bump on a wire (L.  $1\frac{1}{32}$ "-Dia.  $\frac{3}{32}$ " ) the BTR  $\frac{1}{3}$ -watt resistor has all the quality characteristics and features that have long made IRC's BT line "Preferred for Performance." Suitable for Army-Navy RC 10 applications. Available postwar.

## TYPE FRW FLAT WIRE WOUND RESISTOR

Efficient as a tubular wire wound, the type FRW has many features that recommend it for limited space use. In 5 standard sizes to comply with JAN-R-26, specs for RW 20, RW 21, RW 22, RW 24 requirements.

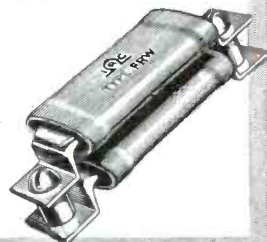

## TYPE GRW GRADE 1-CLASS 1 RESISTOR



Thoroughly dependable and of sound construction these completely sealed units meet or surpass every requirement of JAN-R-26 specs. Made in 7 standard sizes with power ratings of 15 to 140 watts and resistance ranges of 0.1 to 53,000 ohms.

## FINGERTIP CONTROL

No bigger round than a nickel and wafer-thin, this control will find many useful applications in the smaller electronic devices. All-inclusive design eliminates the usual knob, shaft and bushing without impairing functional operation.



For more complete, technical information on any of the above IRC products write to Dept. 2-1

# INTERNATIONAL RESISTANCE CO.

401 N. BROAD STREET • PHILADELPHIA 8, PA.

PREPARED FOR PERFORMANCE  
**IRC**  
\* FIXED & VARIABLE

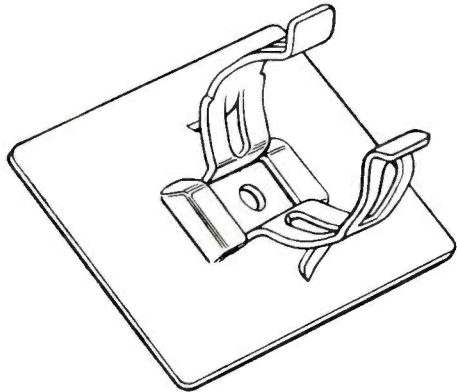
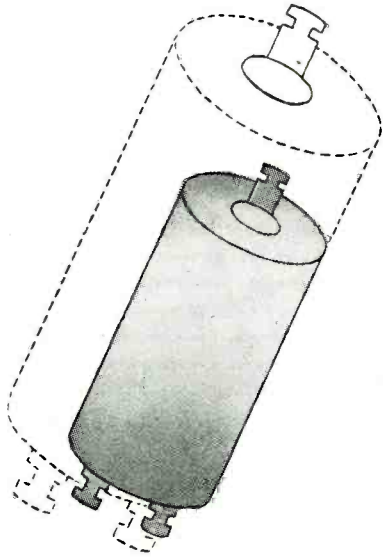

### First Aid to Faster Assembly

Just press the capacitor into this clip—*it's there to stay!* This ingenious Type TH Clip can either be riveted to the chassis or mounted by means of simple embossures already in the chassis. It's another Mallory "First"!

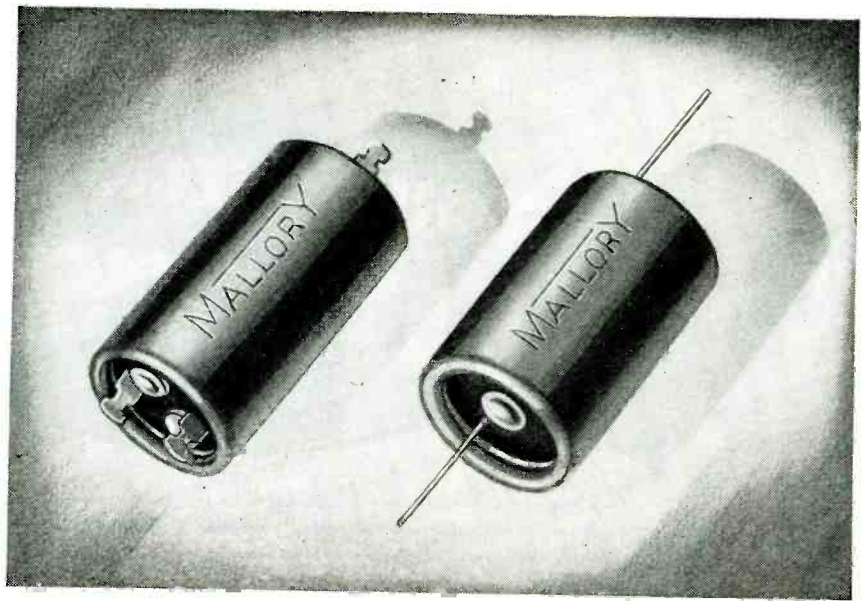

## Smaller and Smaller ... and Better

**P**INT-SIZED capacitors are designed to save space—to help make your equipment more compact. But quality isn't sacrificed in favor of size—*not in these Mallory tubulars!*

Unit for unit, these new Mallory capacitors undermeasure standard cardboard types; yet performance is far more satisfactory. That's due, in part, to precision standards of manufacture—in part to aluminum containers and hermetic sealing.

Single tubular sizes start at  $\frac{9}{16}$ " x  $1\frac{1}{4}$ ", and are available with or without extra insulating covers. Duals include the common negative and separate section types . . . are made in sizes beginning at  $1\frac{3}{16}$ " x  $1\frac{1}{4}$ " . . . and are equipped with easily accessible lug terminals which provide convenient anchor points for wiring.

The new Mallory tubulars are also available in 500- and 600-volt ratings with surge limits of 650 to 750 volts respectively. Write for the Mallory Capacitor Catalog or see your nearest Mallory distributor.

P. R. MALLORY & CO., Inc., INDIANAPOLIS 6, INDIANA

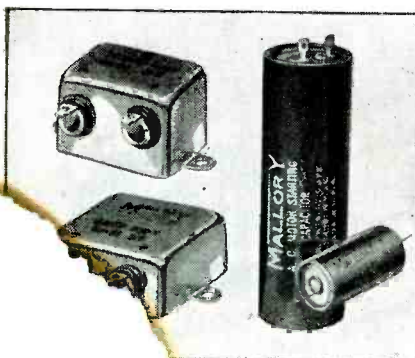

P. R. MALLORY & CO. Inc.  
**MALLORY**  
Electrolytic,  
Film and Paper  
CAPACITORS

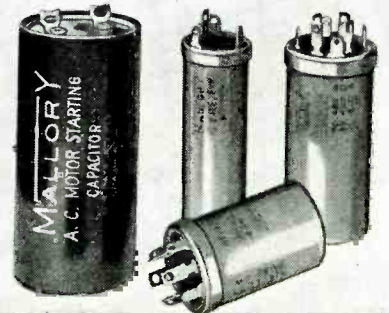

# KEN-RAD

## METAL TUBES

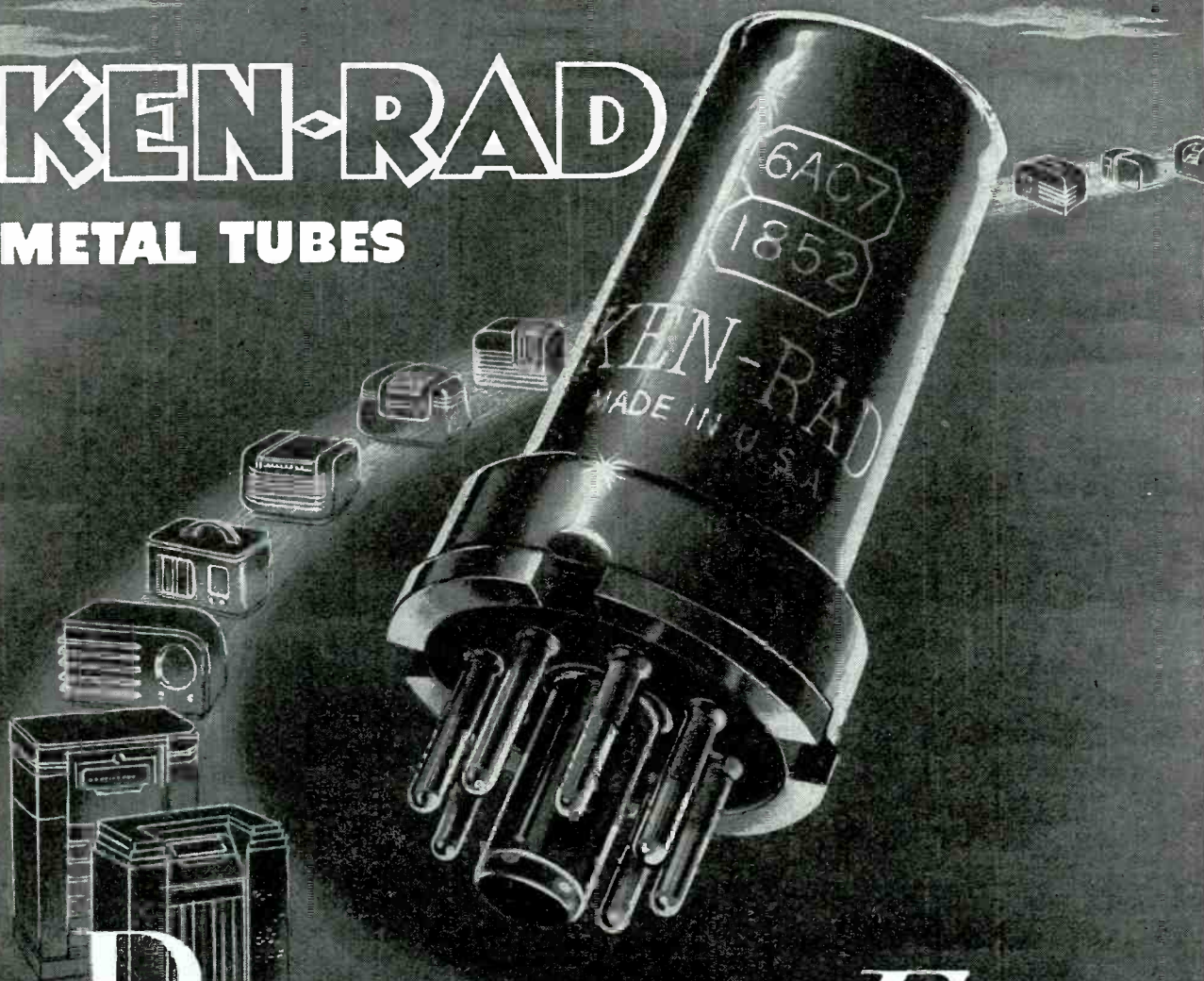

# Better than Ever

New radio sets of production lines demand new heights of tube quality and performance . . . Ken-Rad, with recently added resources and facilities, is superbly equipped to meet these requirements . . . Now and in the future, designers and builders of electronic equipment can rely on Ken-Rad Tubes to meet their most advanced specifications.

✉ Write for your copy of "Essential Characteristics" the most complete digest of tube information available.

# KEN-RAD

DIVISION OF GENERAL ELECTRIC COMPANY  
OWENSBORO, KENTUCKY

176-D-6850

### ↳ AUTOMATIC BEAM CONTROL . . .

Especially important in photographic recording. Beam intensity increased from zero during interval of useful left to right traversal when using single-sweep feature. Intensity automatically reduced to zero when time base is switched from recurrent to single-sweep operation, and returned to original intensity upon initiation of single sweep. For single-sweep use, the extinguishing of the beam except when it is actually plotting a curve, is a remarkable advance in commercial oscillograph design. Minimizes background light. No decrease of visible contrast of desired trace. Results in greatly increased contrast of photograph.

### ↳ TIME BASE WITH ASSURED LINEARITY . . .

Gas triode type. Extended frequency range: 1 sweep every 2 seconds to 50,000 per second. Single sweep if initiated repetitively, operates at writing rates corresponding to 0.5 to 10,000 c.p.s. Single-sweep action so designed that spot remains quiescent at right end of its traversal across screen until initiation by controlling signal, when it rapidly moves to left to assume starting position and then reverses its direction of motion to provide single-sweep across screen at a length of time determined by frequency control. One objection to a gas triode sweep circuit lies in non-linearity of sweep produced, especially at low-sweep rates. Overcome in Type 247 by use of a factory-adjusted compensated circuit which produces a nearly perfect linear sweep.

### ↳ SYNC LIMITER . . .

Time base generator may be synchronized to an external signal, power line or vertical axis signal by means of synchronizing selector switch. Limiting circuit maintains uniform sync regardless of sync signal input level. Synchronized by either positive or negative polarity of sync signal.

### ↳ TEST SIGNAL TERMINAL . . .

Furnishes either a test signal of line frequency at approximately 1 rms volt, or a sawtooth signal of sweep frequency at approximately 10 volts. Front-panel switch. Sawtooth signal available to drive external circuits. Provides modulated signal for FM systems.

### ↳ FUSED TRANSFORMER SECONDARIES . . .

Fuses placed in secondary windings for added protection of transformer, in addition to usual primary fuse. All fuses accessible for replacement without removing instrument from case.

# Extra VALUES

## found only in the DUMONT Type 247 Oscillograph

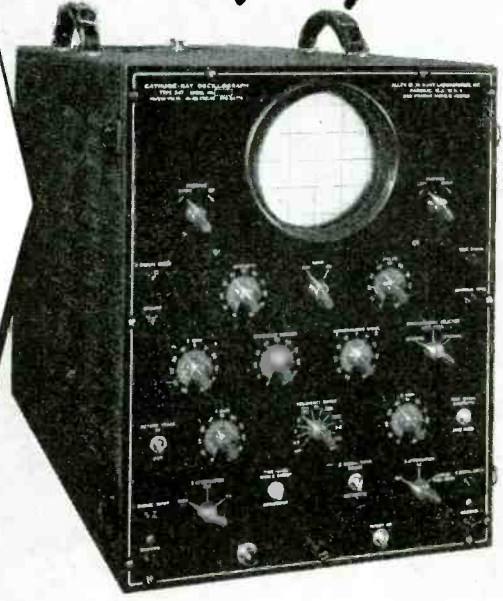

↳ Consider these extra values which are found in this instrument. For above and beyond the exceptional workmanship and the quality materials that do full justice to the well-planned mechanical design, the DuMont Type 247 oscillograph offers many electrical-performance features worthy of particular attention. A few are listed here.

↳ Detailed specifications on request.

© ALLEN B. DUMONT LABORATORIES, INC.

**DUMONT** Precision Electronics & Television  
ALLEN B. DUMONT LABORATORIES, INC., PASSAIC, NEW JERSEY • CABLE ADDRESS: WESPEXLIN, NEW YORK



# Announcing...

## NEWLY DESIGNED

# RADIART AERIALS



WITH FEATURES AND  
ADVANTAGES THAT MAKE  
THEM THE

*Sensation of 1945!*

This new RADIART Line is complete — 3 and 4 Section Models — to fit all cars — all angles — cowl, fender and under hood types — with waterproofed leads of new design featuring lowest capacity — high efficiency construction — with combination pin and bayonet fittings.

All models are made with only highest quality Admiralty brass tubing and stainless steel top section — thereby providing the maximum in

elastic load limit consistent with the utmost in strength and rigidity.

Newly designed method of mounting provides simplest form of one man installation — Mounting is completely waterproofed and impossible to short to the body.

And including those well known RADIART Features of the "Static" muffler magic ring and the permanent all-metal anti-rattler.

★ Check these RADIART advantages and features against all other aerial specifications and you will understand why RADIART AERIALS HAVE ALWAYS BEEN THE STANDARD OF COMPARISON.

*Ask your distributor about deliveries of these new models.*

MANUFACTURED BY THE MAKERS OF RADIART EXACT DUPLICATE VIBRATORS



## Radiart Corporation

3571 W. 62nd STREET

Export Division  
25 Warren St., New York 7, N.Y.

CLEVELAND 2, OHIO

Canadian Office  
455 Craig St., W., Montreal, Canada

NATIONAL RECEIVERS ARE THE EARS OF THE FLEET

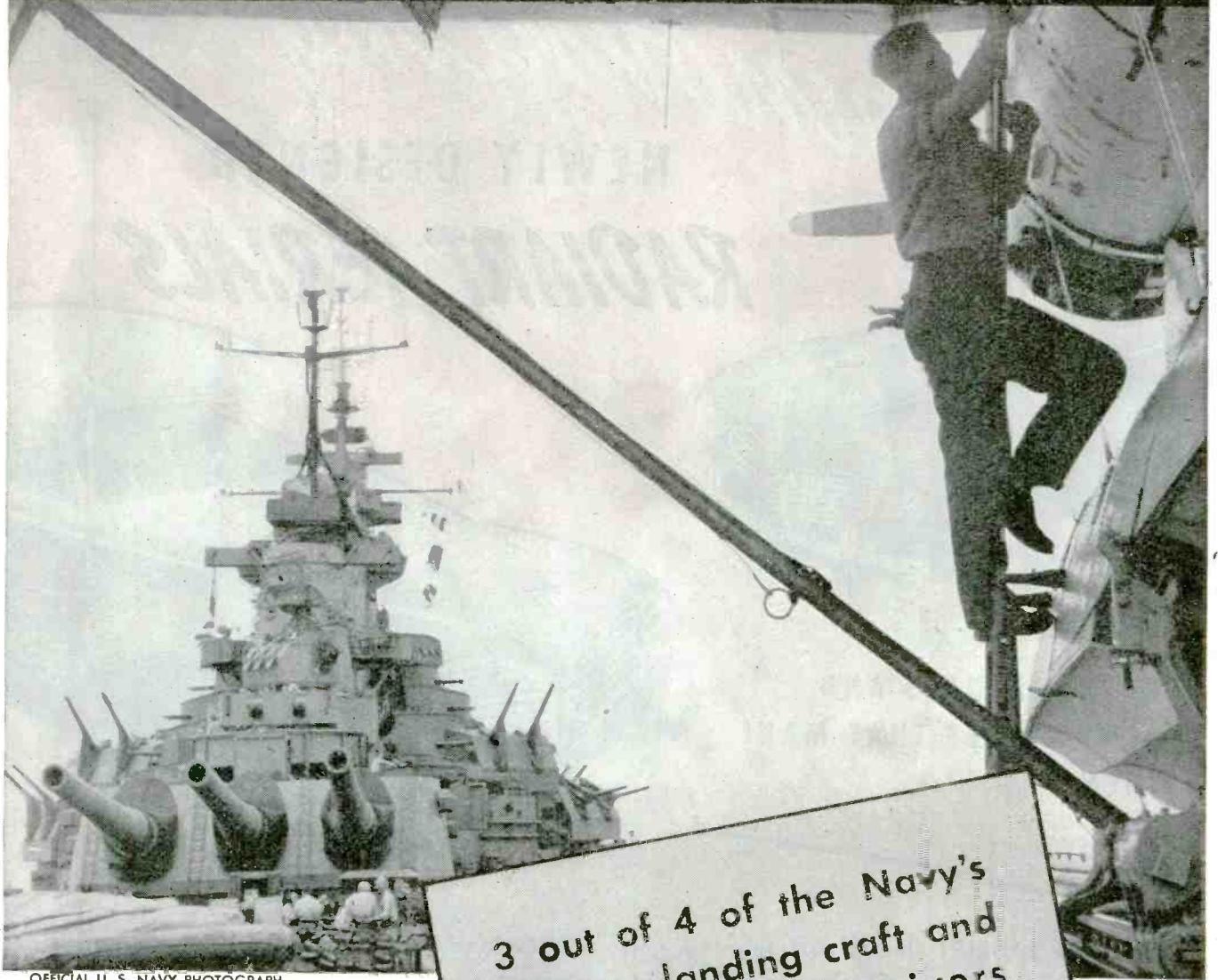

OFFICIAL U. S. NAVY PHOTOGRAPH

3 out of 4 of the Navy's ships — landing craft and larger — use receivers designed by National.

The OS2U "Kingfisher" observation scouting plane provides eyes for the battleship's muscle. Radio provides the indispensable link. It has to be reliable.

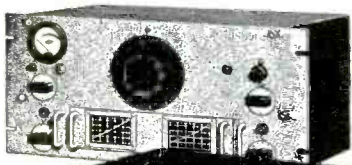

HRO

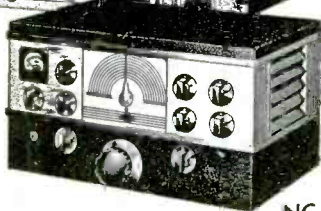

NC-200



**NATIONAL COMPANY**

**MALDEN MASS., U. S. A.**



NATIONAL RECEIVERS ARE IN SERVICE THROUGHOUT THE WORLD

ELECTRONIC INDUSTRIES • September, 1945



**WHEN IT  
COMES TO  
TOLERANCE**

**We are very narrow**

...so narrow, in fact, that we consider a tolerance of + or - 10% the limit of possible variation on our .00025" gauge insulating paper. That's one of the reasons why we're the preferred source for Thin Gauge paper for capacitors, coils, transformers and other insulating purposes. Grades range in thickness from .00025" through .004".

**SCHWEITZER PAPER CO.**

142 MILLER STREET, NEWARK, N. J.  
Plants: Newark, Jersey City, Mt. Holly  
Springs, Pa. Research Laboratories:  
Chrysler Bldg. New York, N. Y.

SPECIALISTS IN **THIN GAUGE** INSULATING PAPERS

*don herold*

# FAMOUS KENYON T-LINE TRANSFORMERS



## BORN IN THE EARLY 1930'S...

We, at Kenyon, take a good deal of pride in our famous T-LINE TRANSFORMERS. Similar units are now produced and advertised by many of our competitors who long ago realized that the T-LINE Housing was a superior Housing in many respects — outdating by years the unpotted open-type Transformers produced by other Transformer Manufacturers.

Additional features of the famous KENYON T-LINE are:

- Excellent Appearance
- Universal Mountings

Mounting centers remain exact because they are die-punched all at the same moment in a single operation.

- A Manufacturer's Dream

Because they provide an excellent electrical and mechanical design that can be made cheaply from plentiful materials.

Kenyon is extremely satisfied with its outstanding engineering developments. The KENYON T-LINE case when produced in the early 1930's was years ahead of its time.

Our engineers are indeed proud to be the originators of such a popular design and point to its duplication with pride.

Kenyon engineering intends to maintain its place as a pioneer in the continued development of outstanding Transformer Equipment.

*Inquiries invited. Write for our NEW 1945 Illustrated Catalog*

**TODAY  
THE MOST  
COPIED-OF-ALL  
TRANSFORMER  
HOUSINGS**



THE MARK OF EXCELLENCE

**KENYON TRANSFORMER CO., Inc.** 840 BARRY STREET  
NEW YORK, U. S. A.

**Eimac**  
TUBES

THE COUNTERSIGN OF DEPENDABILITY IN ANY ELECTRONIC EQUIPMENT



Front view of the 250-watt, 118 mc. Motorola transmitter, now giving Miami police the clearest of coverage for a radius of 30 miles.

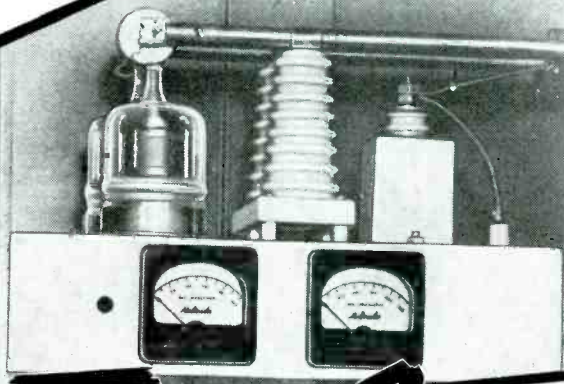

# Top Spot

## IN FM POLICE SYSTEMS



**EIMAC TETRODE 4-125A**

Top honors to Galvin Manufacturing Corporation for building it, and a salute to the police and fire departments of Miami, Florida, for putting it to work in spite of the skeptics! It's the first two-way police radiotelephone system in the United States on frequencies above 100 mc. Twenty-four hours a day, 12 patrol cars in Miami's busy area tune in on signals as solid as a dinner-table conversation from this Motorola 250 watt, 118 mc. FM transmitter.

From the earliest experimental stages of FM broadcasting, Eimac tubes have been lending a hand. Naturally, there are Eimac 4-125A tetrodes (pictured above) in the vital power output stage of Galvin's new Motorola success. Eimac 4-125A's were a logical choice for this transmitter because of their superlative high frequency performance capabilities and their low driving power requirements.

FOLLOW THE LEADERS TO

**Eimac**  
TUBES  
REG. U. S. PAT. OFF.



Ask for your copy of *Electronic Telesis*, the 64-page booklet giving the fundamentals of electronics. It will help electronic engineers explain the subject to laymen. Available in English and Spanish. No obligation, of course.

EITEL-McCULLOUGH, Inc., 1074 San Mateo Avenue, San Bruno, Calif.

Plants located at: San Bruno, California and Salt Lake City, Utah

Export Agents: Frazer & Hansen, 301 Clay St., San Francisco 11, Calif., U. S. A.

1074

### ELECTRICAL CHARACTERISTICS - 4-125A TETRODE

Filament: Thoriated Tungsten	Direct Interelectrode Capacitances (Average)
Voltage . . . . . 5.0 volts	Grid-Plate (Without shielding, base grounded) . . . . . 0.03 $\mu\text{f}d.$
Current . . . . . 6.2 amperes	
Plate Dissipation (Maximum) 125 watts	Input . . . . . 10.3 $\mu\text{f}d.$
	Output . . . . . 3.0 $\mu\text{f}d.$
Transconductance ( $i_b = 50 \text{ ma.}, E_b = 2500 \text{ v.}, E_c = 400 \text{ v.}$ ) . . . . . 2450 $\mu\text{mhos}$	

THEY'LL HELP YOU BUY AND USE CAPACITORS...EFFICIENTLY!



## Up-to-the-minute CAPACITOR and APPLICATION DATA



### HIGHER POWER IN LESS SPACE

with this new 200° C.  
Class C Insulation

Manufacture coils, transformers, or similar wire wound devices? Then you owe it to yourself to investigate the tremendous possibilities of \*CEROC 200—the Sprague inorganic, non-inflammable wire insulation that permits continuous operation to 200° C.

Write for Bulletin 505

A lot of time and effort has gone into making these new Sprague Catalogs invaluable guides to modern Capacitor selection and use for all who buy or use Capacitors.

*CATALOG 10* brings you up-to-the-minute data on time tested *Sprague Dry Electrolytic*

types for practically any application. *CATALOG 20* does the same relative to the most modern line of *Paper Dielectric Capacitor* types on the market today. A copy of either or both will gladly be sent on request.

**Write Today!**

**SPRAGUE ELECTRIC COMPANY • North Adams, Mass.**

# SPRAGUE

\*Trademarks Reg. U. S. Pat. Off.

## CAPACITORS — \*KOOLOHM RESISTORS

it's new!

SARAN

braid

resists

rot,

oil,

moisture,

abrasion,

heat,

cold

for better electrical insulation

Cable and wire braid with insulating qualities far superior to any other material—that's the stimulating news brought by this announcement of Saran braid. It marks an important advance in wire protection and provides long-sought answers to many troublesome problems.

Here is a braid that resists abrasion—Saran is permanently tough and durable. It is fungus and mildew proof—long life is the rule even under adverse service conditions. And, more important to the electrical industry, Saran defies moisture and oil—enemies that attack, and soon rot, ordinary cable coverings.

These better insulating properties point to the use of Saran in myriad applications\* extending all the way from simple extension cords to intricate wires in radio and radar. If you would like to know more about its value to you, write for further details.

*Let's work it out together*

Success in plastics is not a one-man nor even a one-industry job. It calls for the cooperation and combined skill of manufacturer or designer plus fabricator plus raw materials producer. Working together, this team saves time and money and puts plastics to work successfully. Call us—we'll do our part.

**PRESENT AND POTENTIAL USES:**\* Braided covering for wire and cable of all kinds. Especially valuable in guarding against abrasion in such applications as extension cords, etc. Many uses for cable such as household appliance cord that is exposed to moisture and consequent rendering of shock. Resistant to rot caused by entrapped moisture or oil in such applications as automotive wiring.

**PROPERTIES:** Combines toughness with flexibility even at temperature extremes. Flexural strength, p.s.i. 15,000 to 17,000. Highly resistant to broad range of chemicals. Water absorption less than 0.1. Nonflammable. Excellent electrical insulator. Not subject to distortion of flow at contact points. Available in many colors. Softening point 240°-280° F.

**THE DOW CHEMICAL COMPANY • MIDLAND, MICHIGAN**

New York • Boston • Philadelphia • Washington • Cleveland • Detroit  
Chicago • St. Louis • Houston • San Francisco • Los Angeles • Seattle



**PLASTICS**

STYRON • STYRALOY • ETHOCEL • ETHOCEL SHEETING  
SARAN • SARAN FILM • STRIPCOAT

Announcing

THE STARTLING NEW...

# SEEBURG WIRE RECORDER

In addition to the new reliable line of Seeburg Record Changers — after Victory — Seeburg will make available to combination instrument manufacturers — The Seeburg Wire Recorder — truly an amazing accomplishment for home recording. The Seeburg Wire Recorder is being designed to eliminate many of the past disadvantages heretofore associated with home recording — no recording discs to buy — no skilled knowledge necessary to make perfect home recordings and to take favorite programs off the air. Just one simple control knob to operate.

It will be necessary for radio manufacturers to make provision in their circuits to accommodate the Seeburg Wire Recorder and we therefore invite prompt inquiries from interested radio manufacturers.

**SEEBURG  
WIRE  
RECORDER**

**SEEBURG  
RECORD  
CHANGERS**

# Seeburg

J. P. SEEBURG CORP. ★ CHICAGO

**BUY MORE BONDS!**

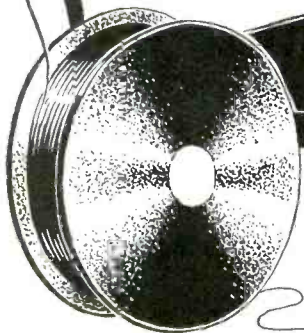

Awarded to the J. P. Seeburg Corporation for outstanding production of war materials in each of its four plants.



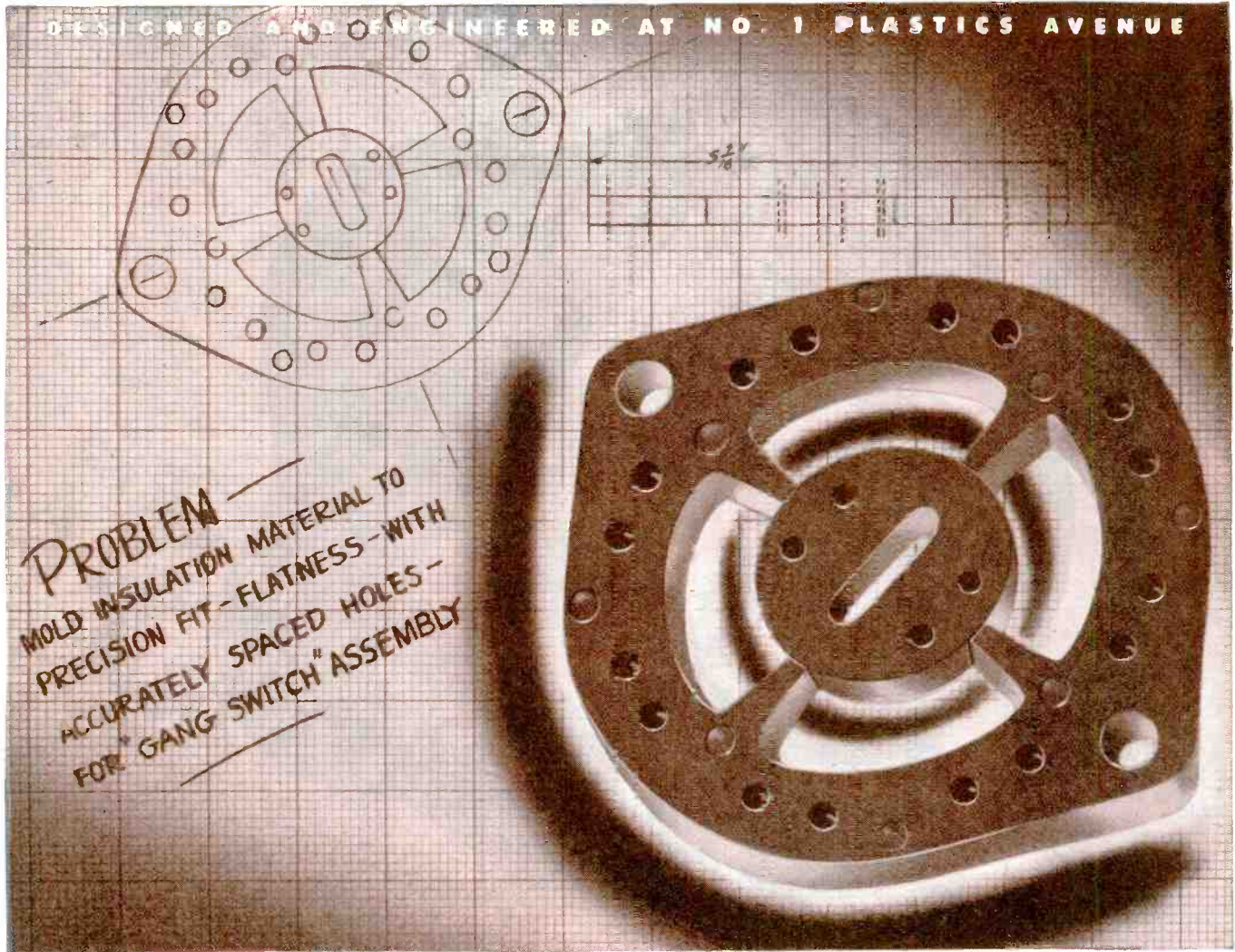

**PROBLEM**  
 MOLD INSULATION MATERIAL TO  
 PRECISION FIT - FLATNESS - WITH  
 ACCURATELY SPACED HOLES -  
 FOR "GANG SWITCH" ASSEMBLY

**ONLY G-E MYCALEX COULD DO THIS ELECTRONIC JOB**

● The rotor and stator assembly for an electronic "gang switch" had to fit exactly; had to be perfectly flat and rigid; with 32 holes molded into the stator for multiple contact points.

The assembly was too delicate and fragile—flatness tolerances were too exacting—for manufacture from fired ceramics. The problem was brought to No. 1 Plastics Avenue. And it was solved with G-E mycalex—compound of glass and powdered mica with a unique combination of properties.

G-E mycalex proved to be the most satisfactory material that could be molded for this electronic application.

And G-E mycalex may be the answer to that insulation problem of yours. For information, write to: Section T-2, Plastics Divisions, General Electric Company, 1 Plastics Avenue, Pittsfield, Massachusetts.

Hear the General Electric radio programs: "The G-E All-Girl Orchestra" Sunday 10 P.M. EWT, NBC. "The World Today" news every weekday 6:45 P.M. EWT, CBS. "G-E House Party" every weekday 4:00 P.M. EWT, CBS.



**G-E MYCALEX**

**A Unique Combination of Properties**

1. High dielectric strength
2. Low power factor
3. Prolonged resistance to electrical arcs
4. Chemical stability—no deterioration with age
5. Dimensional stability—freedom from warpage and shrinkage
6. Imperviousness to water, oil, and gas
7. Resistance to sudden temperature changes
8. Low coefficient of thermal expansion
9. High heat resistance

*Samples Supplied on Request*

**GENERAL  ELECTRIC**  
CD45-M2

**BUY WAR BONDS**

**LOW FREQUENCIES**  
**ACCURACY TO 1/1,000th of 1%**

*Actual Size*

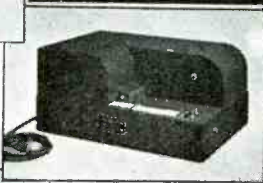
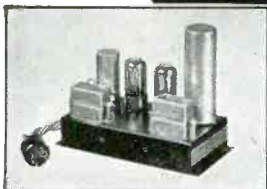

**TOP**  
**FREQUENCY STANDARD**  
*(60 cycle) for use with external power supply*

**CENTER**  
**CHRONOGRAPH**  
*Records time intervals with resolution to .001 second*

**BOTTOM**  
**FREQUENCY STANDARD**  
*(120 cycles) with self-contained power supply*

These tuning forks which include new engineering principles, provide frequencies from 120 to 1,000 cycles directly with an unqualified guarantee of accuracy to 1 part in 100,000 over a wide temperature range. (Better than 1 second in 24 hours). Closer tolerances are obtainable on special order.

These tuning fork assemblies are available only in single or multi-frequency instruments of our own manufacture which are de-

signed to test, measure or control other precision equipment by mechanical, electrical, acoustical or optical means.

The dependability of these frequency standards is being demonstrated for myriad purposes in all climates and under all working conditions.

If you have need for low frequency standards of exceptional accuracy, your inquiries are invited.

**American Time Products, Inc.**

**580 Fifth Ave.**

**New York, N. Y.**

*Dist. of Western Electric & Watch Master Watch-rate Recorders*



# From Cooking to Counting **ELECTRONICS** does it better

## for the **FOOD** Industry

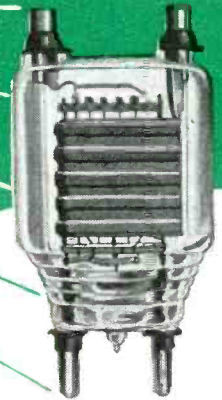

### **How Electronics Can Serve The Food Industry**

**ELECTRONIC HEATING** — for Sterilization, Pasteurization, Cooking, Dehydration

**ELECTRONIC CONTROLS**—for Deodorizing, Levels, Motion-Initiating Temperature, Flow

**ELECTRONIC REGULATION** — for Density as applied to dairy industry

**ELECTRONIC COUNTING, CANDLING, SORTING, COLOR MATCHING, INSPECTION**

**ELECTRONIC DRIVEN MOLECULAR VIBRATORY SYSTEMS** for Homogenization, Emulsification, Germ-Killing and Destruction of Enzymes

**ELECTRONIC MEASUREMENT AND ANALYSIS OF COLOR, HUMIDITY, TURBIDITY, FLOW AND SUPERSATURATION OF FLUIDS**

**pH DETERMINATION BY ELECTRONIC MEASUREMENT AND CONTROL THEREOF**

**ELECTRONIC DETERMINATION OF BUTTERFAT CONTENT**

**ELECTRONIC DEVICES** — for location and indication of foreign particles in finished product

All but unlimited, the range of applications of electronics to the food industry encompasses every manufacturing, processing and handling operation. There is scarcely a phase or branch of the industry in which electronics cannot be employed to improve production methods, and to achieve a better product — for less money . . . Stepped up production, automatic control, uniform quality, saving of needed manpower — these are but a few of the advantages that electronics offers the food industry.

As an engineering service and manufacturing organization, we are recognized specialists in the design, development and manufacture of custom-built electronic equipment.

Our engineers are available for consultation.

Write to learn how Sherron Electronics can help you.

**Sherron  
Electronics**

**SHERRON ELECTRONICS COMPANY**

Division of Sherron Metallic Corporation

1201 Flushing Avenue

Brooklyn 6, N. Y.

**"WHERE THE IDEAL IS THE STANDARD, SHERRON UNITS ARE STANDARD EQUIPMENT"**

# The Latch String Is Always Out

## Why Not Pay Us a Visit

If you would permit us to pilot you through the various departments of our modern plant, you would readily understand why Jefferson Electric has earned the reputation for sustained quality in quantity production.

You would agree that it would be difficult to find a plant with all of the many features needed to produce in such quantities with such high standards of quality, accuracy and uniformity.

Engineering, research, experimental departments geared to the latest manufacturing methods and technique are combined with modern equipment and unusual esprit de corps.

When in Chicago, plan to pay us a visit, —our suburban location is readily accessible. For your convenience you can call us by local Chicago telephone—Mansfield 7161. JEFFERSON ELECTRIC COMPANY, Bellwood (Suburb of Chicago), Illinois. *In Canada:* Canadian Jefferson Electric Co., 384 Pape Avenue, Toronto, Ontario.

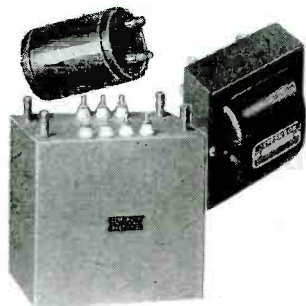

# T R A N S F O R M E R S

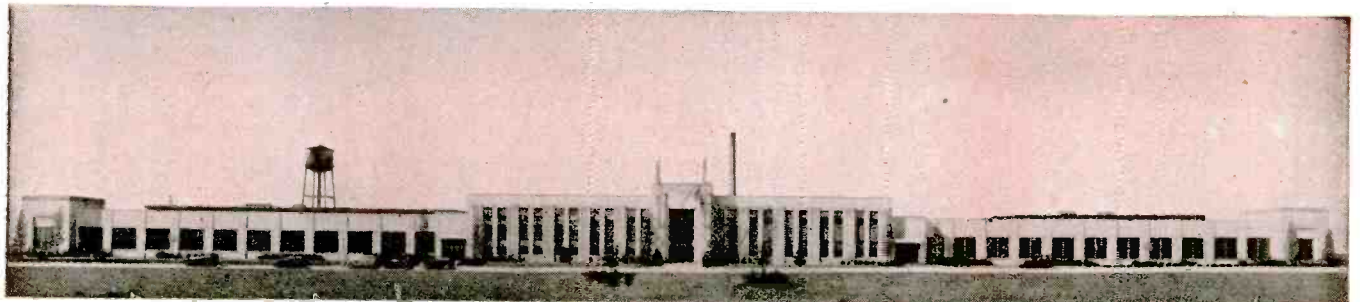

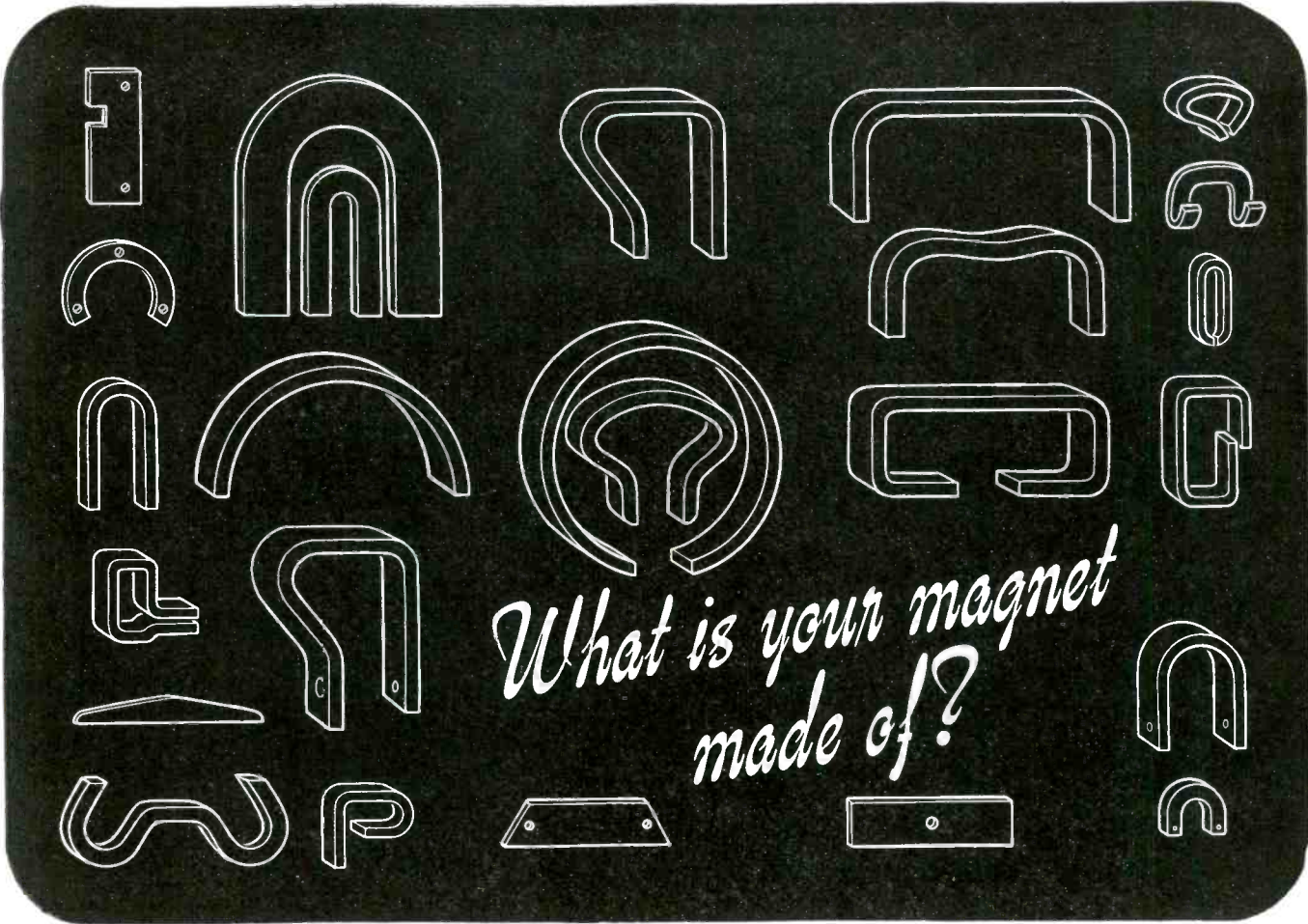

*What is your magnet made of?*

(This is the first of three advertisements regarding permanent magnet materials)

## PERMANENT MAGNET STEELS

Natural successors to primitive soft iron magnets were those of carbon steel to which, later, were added chromium, tungsten or cobalt. They may be formed from rolled stock, or cast in desired shapes, and can be drilled and machined after an annealing operation. They are heated to precise temperatures and then quenched in oil or water to develop permanent magnet properties.

Materials in this group have high residual inductions and coercive forces ranging from 60 oersteds in the chromium steels to 250 oersteds in the high cobalt grades. Because these materials are machinable, they may be used to advantage in some applications requiring machining and having magnetic requirements within their limitations. Proper allowance

must be made for the demagnetizing effect of stray magnetic fields and vibration, and care must be taken that their temperature limits are not exceeded.

The Indiana Steel Products Company uses numerous magnet steels and Alnico alloys in both cast and formed magnets, and has the specialized experience to select the material best suited to each specific job, engineering personnel to create the optimum design, and equipment to furnish the permanent magnets most suitable for any application. The complex factors of magnet design make engineering consultation advisable; many problems call for development or research. Write for complete information. Send for free copy of technical hand book: "Permanent Magnet Manual."

\*\*\* **THE INDIANA STEEL**

6 NORTH MICHIGAN AVENUE, CHICAGO 2, ILLINOIS



**PRODUCTS COMPANY** \*\*\*

Copr. 1945, The Indiana Steel Products Co.  
SPECIALISTS IN PERMANENT MAGNETS SINCE 1910

Controlled  
Brilliance...

Thanks to a

# MALLORY VARIABLE RESISTOR

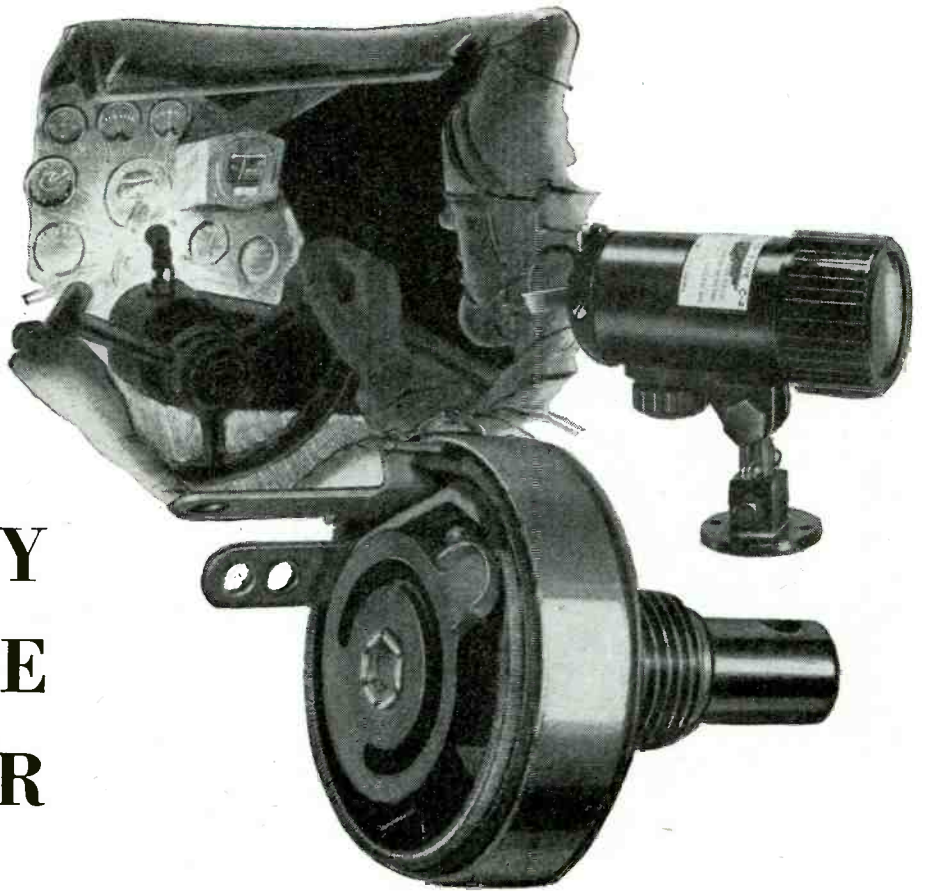

**C**ONTROLLING the brilliance of this small cockpit lamp, made by Standard Aircraft Products, Dayton, Ohio, is a variable wire wound Mallory Resistor.

This lamp, used as an auxiliary light to illuminate the instrument panel or any area in the cockpit, is only  $1\frac{3}{4}$ " in diameter and  $5\frac{1}{16}$ " long. To control it, a standard Mallory Resistor of the C type was selected because of its compact size and precision construction . . . rugged enough to operate efficiently even when subjected to extreme vibration. In this application, a 50 ohm unit is being used for 12 volt operation, and a 200 ohm unit for 24 volt operation.

Standard C type Mallory Variable Resistors are available from 6 to 15,000 ohms at 2 watts. Other Mallory variable resistors are available in ratings from 2 to 9 watts, and from 0.5 to 150,000 ohms resistance in single and multiple units. Variable carbon resistors range from 5000 ohms to 9 megohms. Fixed and adjustable wire wound resistors are manufactured in a broad range of resistances, rated from 10 to 200 watts.

Complete details covering resistors, capacitors, switches, power supplies and other standard precision electronic parts are in the Mallory catalog. Ask your nearest Mallory Distributor for a copy, or write us today.

Make it a policy to consult Mallory for engineering assistance while your designs are still in the blueprint stage.



P. R. MALLORY & CO., Inc., INDIANAPOLIS 6, INDIANA

P. R. MALLORY & CO. Inc.  
**MALLORY**  
FIXED AND VARIABLE  
**RESISTORS**

Under all temperature and climatic conditions

# L-R BLOWERS

give maximum  
heat dispersion

LIGHT - COMPACT - EFFICIENT



**MODEL 1 1/2**  
Weight (less motor): 2 oz.  
Output: 15 C.F.M. at 8000 R.P.M.

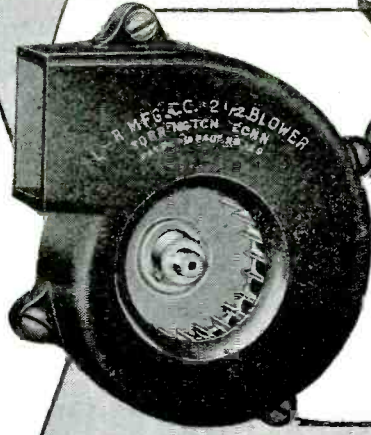

**MODEL 2**  
Weight (less motor): 4 1/2 oz.  
Output: 25 C.F.M. at 3000 R.P.M.

*It's New!*

**MODEL 2 1/2**  
Weight (less motor): 4 oz.  
Output: 50 C.F.M. at 8000 R.P.M.  
Height: 4 1/2"

L-R Blowers produce maximum C.F.M. with minimum space and weight. Light-weight, high-impact plastic housings. Turbo-type wheels. Clockwise or counter-clockwise rotation.

**MODEL 3**  
Weight (less motor): 32 oz.  
Output: 260 C.F.M. at 8000 R.P.M.  
Height: 6 1/2"

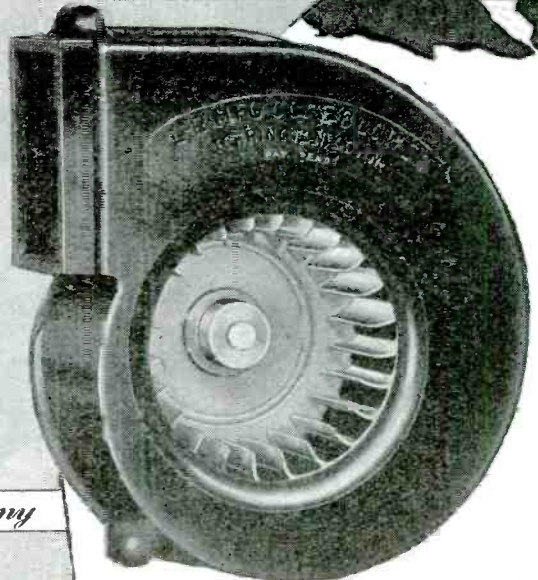

L-R MANUFACTURING CO. Division of

The **RIPLLEY** Company

TORRINGTON, CONNECTICUT

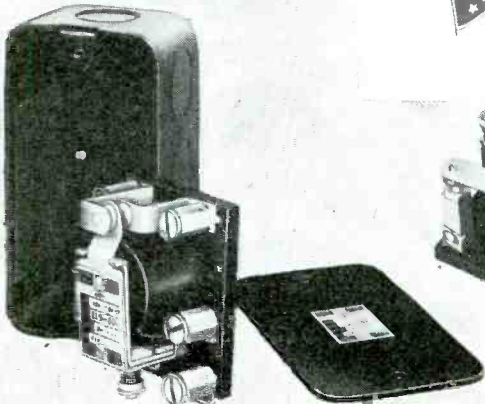
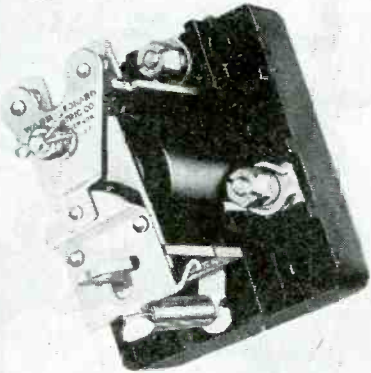
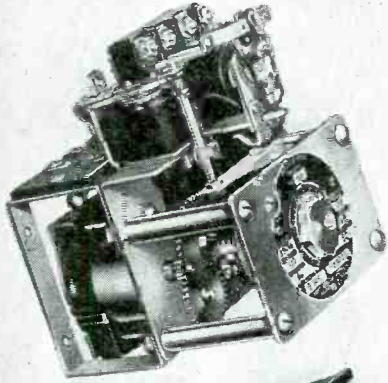
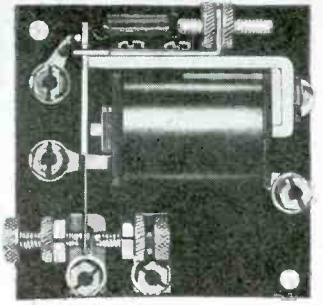
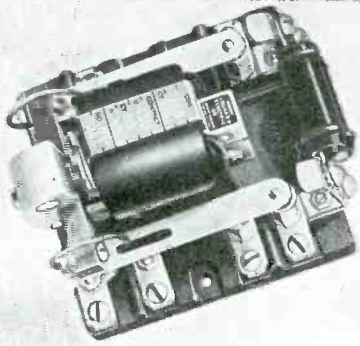
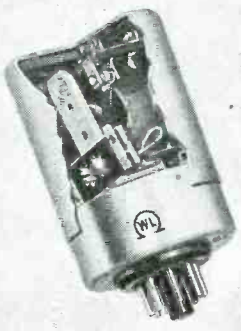

# RELAYS

## FOR POSTWAR JOBS

It is an interesting commendation that many of the regular line of Ward Leonard Relays have so effectively served the needs of our Army, Navy and Air Corps. This is a tribute to the design and quality of Ward Leonard routine production.

Designers of postwar products may rest assured that when they select relays from the Ward Leonard line, they have chosen relays of proven merit. The line includes types and capacities for practically every commercial, industrial and communications application.

*Bulletins available describing light, intermediate and heavy-duty relays in various contact combinations. Send for bulletins of interest to you.*



★ ★ ★  
BUY  
MORE WAR  
BONDS



# WARD LEONARD

## RELAYS • RESISTORS • RHEOSTATS

Electric control  devices since 1892

*Offices in all principal cities*

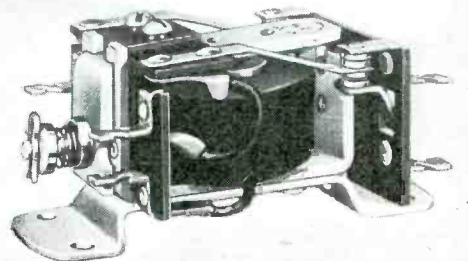
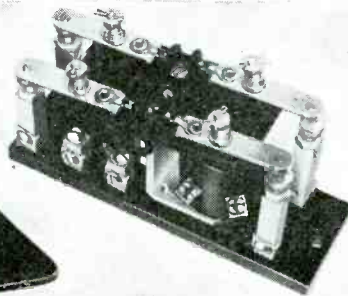

**WARD LEONARD ELECTRIC COMPANY • 61 SOUTH ST. • MOUNT VERNON, N. Y.**



# THE **Thermatron** LINE

of electronic dielectric heat generators includes a size for every use—for heating thermosetting materials—for welding thermoplastics—for laboratory research or for rugged production requirements.

## THREE OUTSTANDING UNITS



**"The HEATMASTER".** Type K-5—5 KW. output. Applicable for plastics, dehydration, sterilization and other purposes. BTU output, 17,065 per hour. 220 volts, 60 cycle, three phase. 5-15-30 megacycle frequency as specified. Width: 24", depth: 28", height: 59". Weight, approximately 1,000 lbs. Mounted on rubber casters. As supplied for plastics or general purpose use, Type K-5 includes electrodes, built-in work chamber, automatic operation. Completely self-contained, ready-to-use. A compact, power-packed model, particularly designed for heavy-duty preheating in the plastic molding industry where floor space is at a premium. *Will heat a 3.3 pound preform in one minute or a 5 pound preform in 90 seconds.* Its generous capacity also makes it suitable for rugged general purpose production use as well as research requirements involving substantial power. Type K-5-S is substantially the same as Type K-5 except that it is especially adapted for bonding, welding or sealing thermoplastic sheeting, such as Koroseal or Vinylite.

**"The HEATMASTER Jr."** Type K-3—2½ KW. output. For laboratory and plastics uses. BTU output, 8,550 per hour. 220 volts, 60 cycle, single phase. 5-15-30 megacycle frequency as specified. Width: 24", depth: 28", height: 59". Weight, approximately 750 lbs. Mounted on rubber casters. As supplied for heating preforms, Type K-3 includes electrodes, built-in work chamber, automatic operation, and constitutes a *completely self-contained, ready-to-use model for pre-heating plastic preforms or any other use requiring moderate power.* Also supplied as Type K-3-S especially adapted for bonding, welding or sealing thermoplastic sheeting.

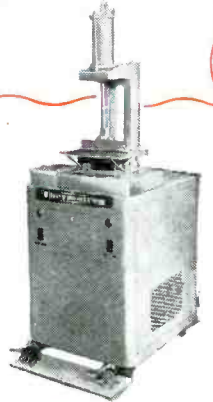

**"The WELDMASTER".** Type K-1—1 KW. output. For sealing or general purpose use. BTU output, 3,413 per hour. 110 or 220 volts, 60 cycle, single phase. 5-15-30 megacycle frequency. Width: 24", depth: 28", height: 38". Weight, approximately 600 lbs. Mounted on rubber casters. May be fitted with same oven or electrode chamber as Types K-5 and K-3. Excellent as a pilot model for development work or for production requiring limited power.

**"The POWERMASTER".** Type K-15. For heavy duty requirements, the Type K-15 Thermatron with an output of 15 kilowatts is available as a standard model. BTU output 51,200 per hour. 220-440 volts, 60 cycle, three phase. A high powered model of unusual flexibility, available in 5, 15 or 30 megacycles.

**SERVICE — NATIONWIDE**

**GUARANTEE — COMPLETE**

Send for our **THERMATRON** circular describing standard models ranging in size from 500 watts to 30 kilowatts. Units of any size designed and built.



**RADIO RECEPTOR COMPANY, Inc.**  
251 WEST 19th STREET  
NEW YORK 11, N. Y.

Engineers and Manufacturers of Airway and Airport Radio Equipment  
SINCE 1922 IN RADIO AND ELECTRONICS



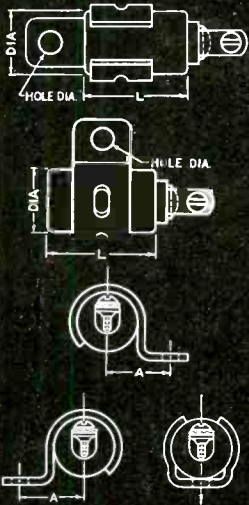

# FAST RADIO NOISE-SUPPRESSION *Capacitors*

FAST radio noise-suppression capacitors are of *approved* design and meet the specifications for these types in every respect.

They are particularly efficient in suppressing noise from dynamotors, generators, motors and other motor driven devices which might otherwise impair radio reception.

The illustrations show the rugged construction of the screw-type terminals to safely carry heavy currents. Units are encased in brass containers with a heavy tin dip—oil impregnated, filled, and hermetically sealed to meet the most severe operating conditions.

These capacitors can be supplied in the following capacities and voltage ratings: .01 MFD; .10 MFD; .25 MFD and .50 MFD—100 V. DC.

or 500 V. AC/DC. Side or end BRACKETS are available with mounting holes in 3 sizes. Side bracket can be placed in either of two positions depending upon mounting requirements, and can be provided with mounting hole at various distances from center of terminal. Below is a partial list of these types.

Write for prints or any additional data on these or other units—we will be happy to serve you.

### Standard or Special Units to Meet Every Need

*FAST Capacitors are produced in many types and sizes in standard or special designs. We can supply paper capacitors—oil or wax impregnated—rectangular or tubular—in sizes from the smallest to the largest.*

**"When You Think of Capacitors . . . Think FAST"**

CAP. MFD.	VOLTS	DIMENSIONAL DATA		
		DIA.	LGT.	MOUNTING HOLE DIA.
.01	100 D.C.	11/16	13/16	7/32; 9/32 or 11/32
.10	100 D.C.	11/16	1-3/8	7/32; 9/32 or 11/32
.25	100 D.C.	3/4	1-9/16	7/32; 9/32 or 11/32
.50	100 D.C.	1	1-13/16	7/32; 9/32 or 11/32
.01	500 AC/DC	11/16	27/32	7/32; 9/32 or 11/32
.10	500 AC/DC	1	1-1/2	7/32; 9/32 or 11/32
.25	500 AC/DC	1	2-9/16	7/32; 9/32 or 11/32

## JOHN E. FAST & CO.

Capacitor Specialists for Over a Quarter-Century  
**3129 North Crawford Avenue, Chicago 41**

Canadian Representatives: Beupre Engineering Works, Reg'd.  
 2101 Bennett Avenue, Montreal, for Power Factor Correction  
 J. R. Longstaffe, Ltd., 11 King Street, W., Toronto 1, for Special Applications

RADIO RECEPTOR COMPANY, Inc.

*makes a Statement!*

Heinemann circuit breakers form an essential part of our equipment. As you know, we need the highest quality standard components for the THERMATRON as they are subject to rugged use in industrial plants, - often by unskilled help - a test which we feel the Heinemann Circuit Breaker fully meets.

An unsolicited comment from Radio Receptor Company, Inc., in a letter to us makes the revealing statement above. The electronic high frequency industrial power generator shown here requires unflinching but flexible circuit protection. *Instantaneous trip* on short circuit, *delayed trip* on minor overloads in inverse ratio to current—these are the features that caused Radio Receptor Company to choose

# HEINEMANN MAGNETIC CIRCUIT BREAKERS

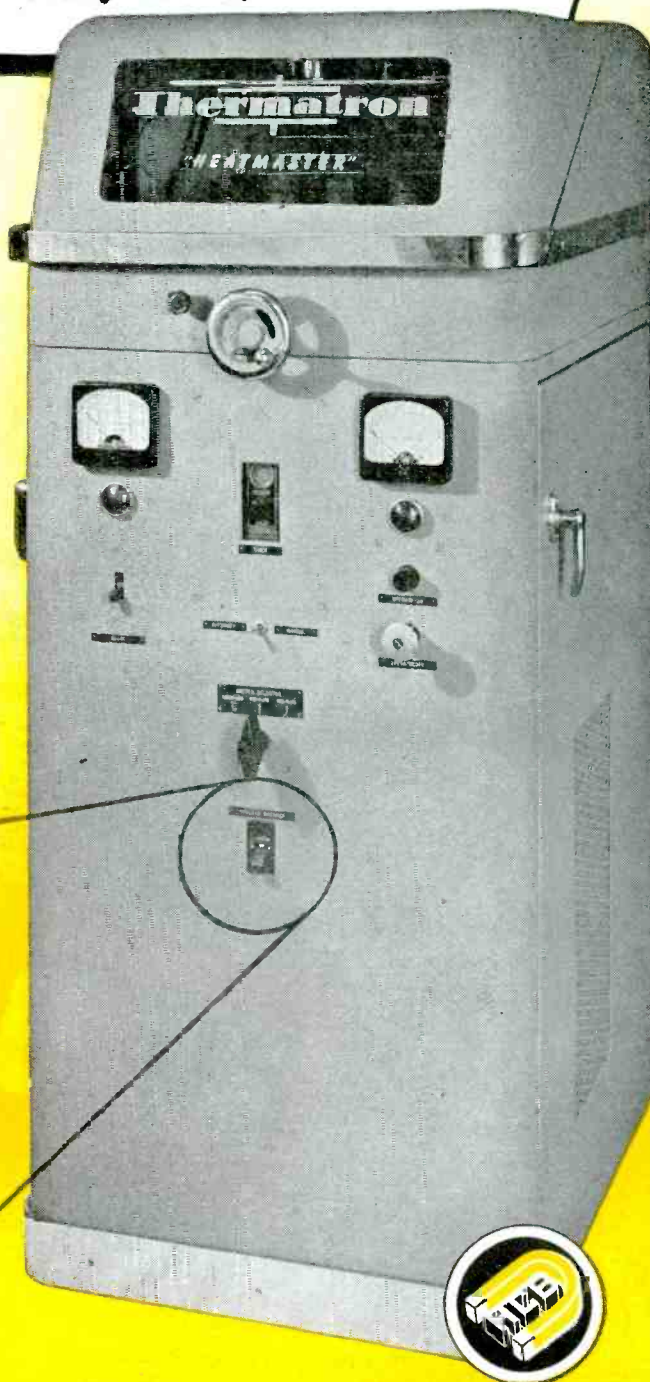

Send for Catalog With Complete Line and Engineering Data  
**HEINEMANN CIRCUIT BREAKER CO.**  
Subsidiary of Heinemann Electric Co. — Established 1888  
137 PLUM ST. TRENTON, N. J.



**NO DAMP AMPS**

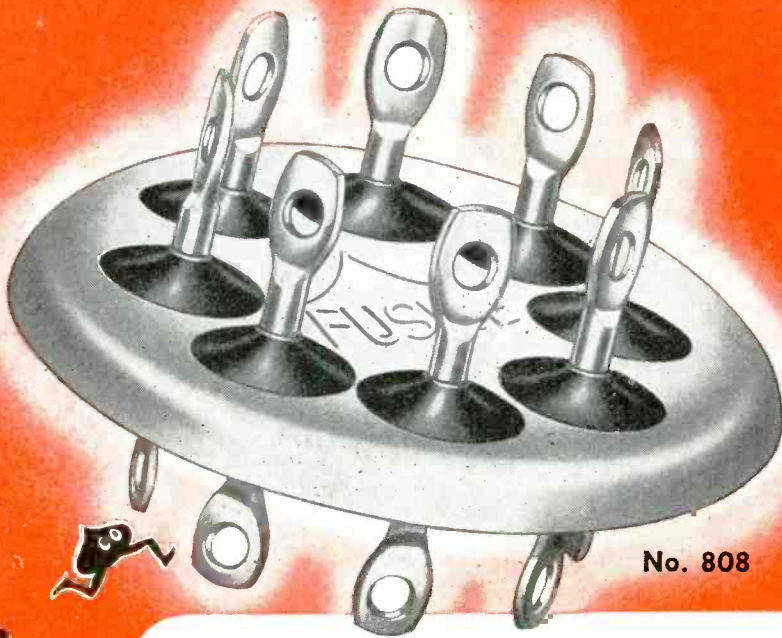

No. 808

<b>No. 100</b> SINGLE FLANGE DIAMETER 5/16" (App.)	<b>600</b> SERIES 1" DIAMETER (.952)	<b>800</b> SERIES 1 1/4" DIAMETER (1.235)
--	--	---

INSERTS IN 3/16" HOLE	 602	 802
	 603	 803
	 604	 804
	 605	 805
	 606	 806
		 807
		 808



Hole punched and adapter socket formed to receive multi-terminal panels.



Fusite multi-terminal panel used as cover for container. A single sealing operation.

**FINISH** . . . means "to end". It also means "to bestow the last required labor upon; complete; perfect." Just so with the new fused electro-tin finish on **FUSITE** Hermetic Terminals. Microscopically, ordinary electro-tin finish looks like this **FUSITE's** fused electro-tin finish is like this There are no pin-point holes in the finish where oxidation can start to work. **FUSITE's** new and proved fused electro-tin finish provides even, uniform protection. It is the completely satisfactory finish to the completely satisfactory hermetic seal . . . **FUSITE** . . . which satisfactorily stands the latest J-A-N tests. **FUSITE's** electrical properties have been bettered, too! Whereas a test of 500 meg, on electrical leakage, was formerly considered satisfactory, the new **FUSITE** now tests close to infinity. Leakage across the glass insulation is almost nil. This mark is your assurance of the ultimate in hermetic terminals . . . for your war products of today; for your "peace-work" of tomorrow.

**WITH  
FUSITE  
SEALS**

No. 100

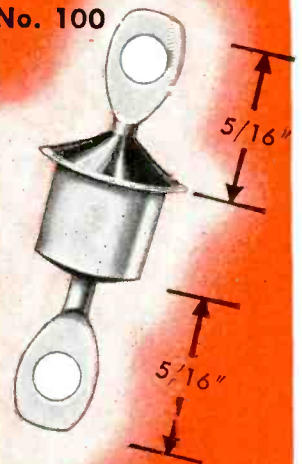

**PRODUCTION HINT**

Solder on the lead wire; then bend the flattened terminal end at the edge of the hole to get greater clearance inside the "can."



**GLASS TO METAL**



A FLYING AMP,  
CAN'T TAKE THE DAMP  
AND BUZZ 'EM FOR THE NAVY;  
SO WE KEEP DRY,  
WHEN FLYING HIGH,  
WITH **FUSITE SEALING**, SAVVY?

**CINCINNATI ELECTRIC  
PRODUCTS COMPANY**

CARTHAGE AT HANNAFORD, NORWOOD  
CINCINNATI 12, OHIO

Copyright 1945, Cincinnati Electric Products Co.

**FUSITE**  
**HERMETIC TERMINALS**  
**NO DAMP AMPS!**

# 6AK5

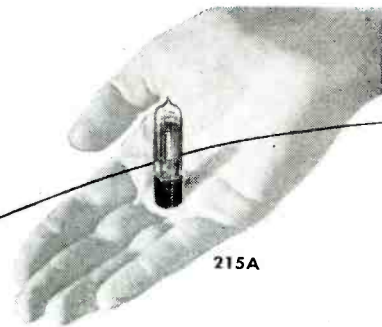

## *the tube that grew out of a "peanut"*

When the returns are all in, many big scientific developments of World War II will be found to have roots deep in the past.

Certainly this is true of the revolutionary 6AK5 — developed by Bell Laboratories, and manufactured by Western Electric.

Back in World War I, these two organizations developed the 215A, so-called "peanut" tube; the first tube whose filament was powered by a single dry-cell. Down the years, research in electronics continued to give birth to new tubes which made "Western Electric" a synonym for performance and reliability. When the coaxial cable system was planned, with vacuum tube repeaters every few miles, the Laboratories developed the 386A tube. At the coming of war, the Bell Laboratories were

foremost in design of broadband amplifiers and of the vacuum tubes to make them work.

Indispensable for certain military equipment, the 386A was developed into the 717A tube, and still further refined in the 6AK5.

Besides producing 6AK5's in large quantities, Western Electric responded to emergency needs of the Army and Navy by furnishing design specifications and production techniques to other manufacturers. Today, at least five other companies are in quantity production.

The 6AK5 is another example of Bell Laboratories and Western Electric teamwork, which created many of the war's outstanding electron tubes. These tubes will play important peacetime roles in television and other arts of communication.



**BELL TELEPHONE LABORATORIES**

Exploring and inventing, devising and perfecting for our Armed Forces at war and for continued improvements and economies in telephone service.

## *Western Electric*

Manufacturing team-mate of Bell Laboratories, and the country's largest producer of communications and electronic equipment for war.

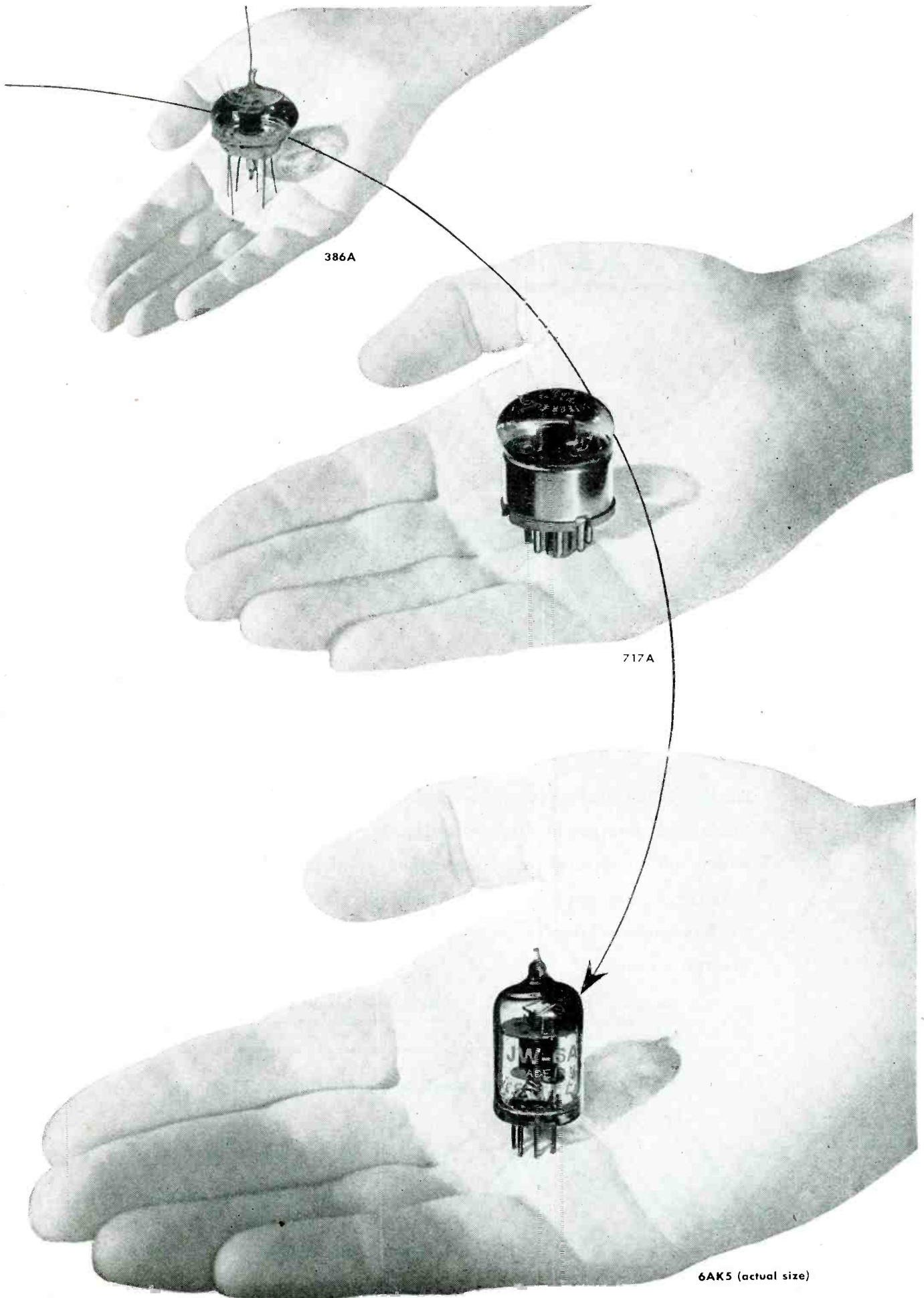

386A

717A

6AK5 (actual size)

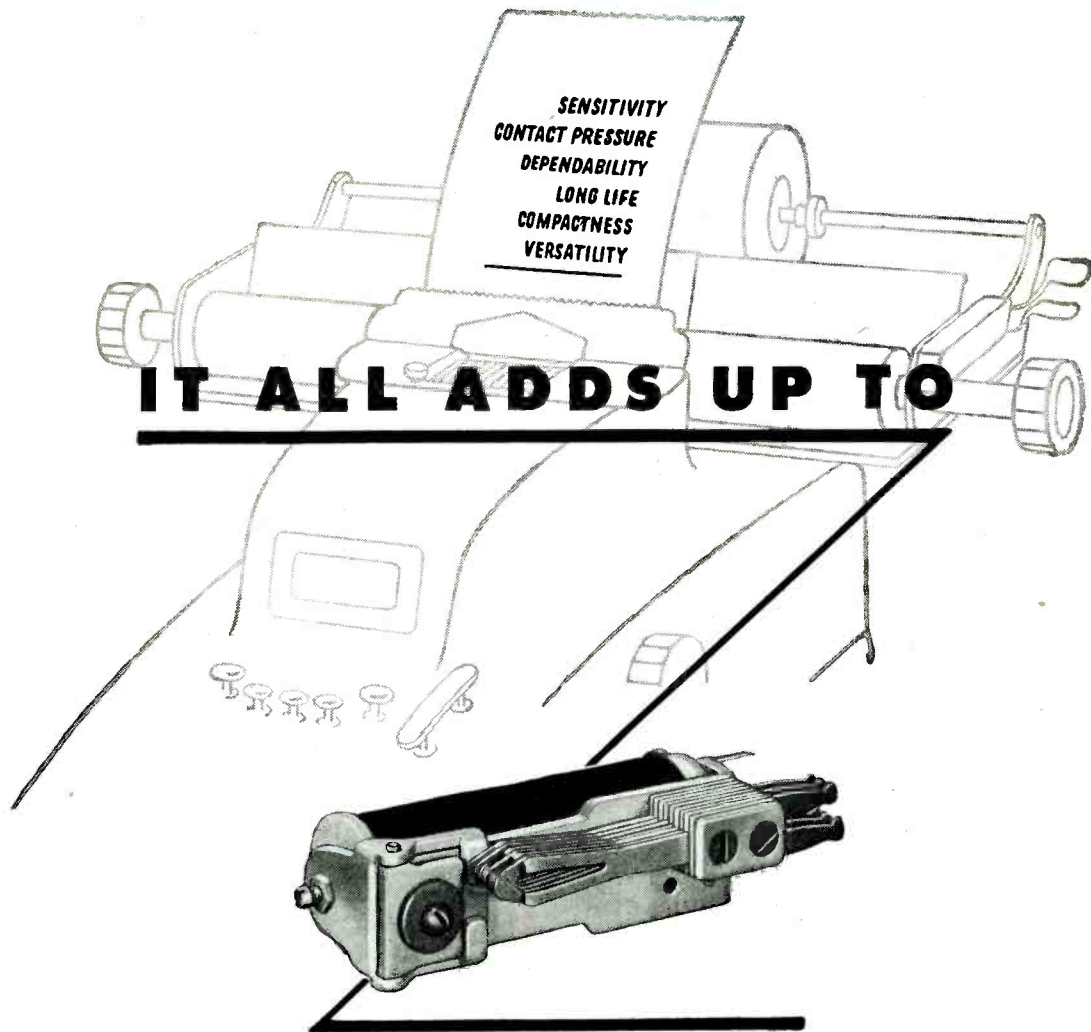

## **AUTOMATIC ELECTRIC'S CLASS "B" RELAY**

All six of the features you want—perfectly combined in one unit—that's what you get in this new relay. It meets all purposes, in widely varied applications, without compromising with the most exacting requirements. For in the Class "B" relay, Automatic Electric has combined the features you need—*all* of them, and each in greatest measure.

*Independent twin contacts for dependable contact closure... efficient magnetic circuit for sensitivity and high contact pressure . . . unique armature bearing for long wear under severe conditions . . . compact*

*design for important savings in space and weight. Now available for coil voltages to 300 volts DC and 230 volts AC, with capacities up to 28 springs; also with magnetic shielding cover, when specified.*

The Class "B" relay, and many others, are shown in Catalog 4071. Write today for your copy.

*Relays by*

**AUTOMATIC  ELECTRIC**

**AUTOMATIC ELECTRIC SALES CORPORATION**

1033 WEST VAN BUREN STREET • CHICAGO 7, ILLINOIS

*In Canada: AUTOMATIC ELECTRIC (CANADA) LIMITED, TORONTO*

**PARTS AND ASSEMBLIES FOR EVERY ELECTRICAL CONTROL NEED**



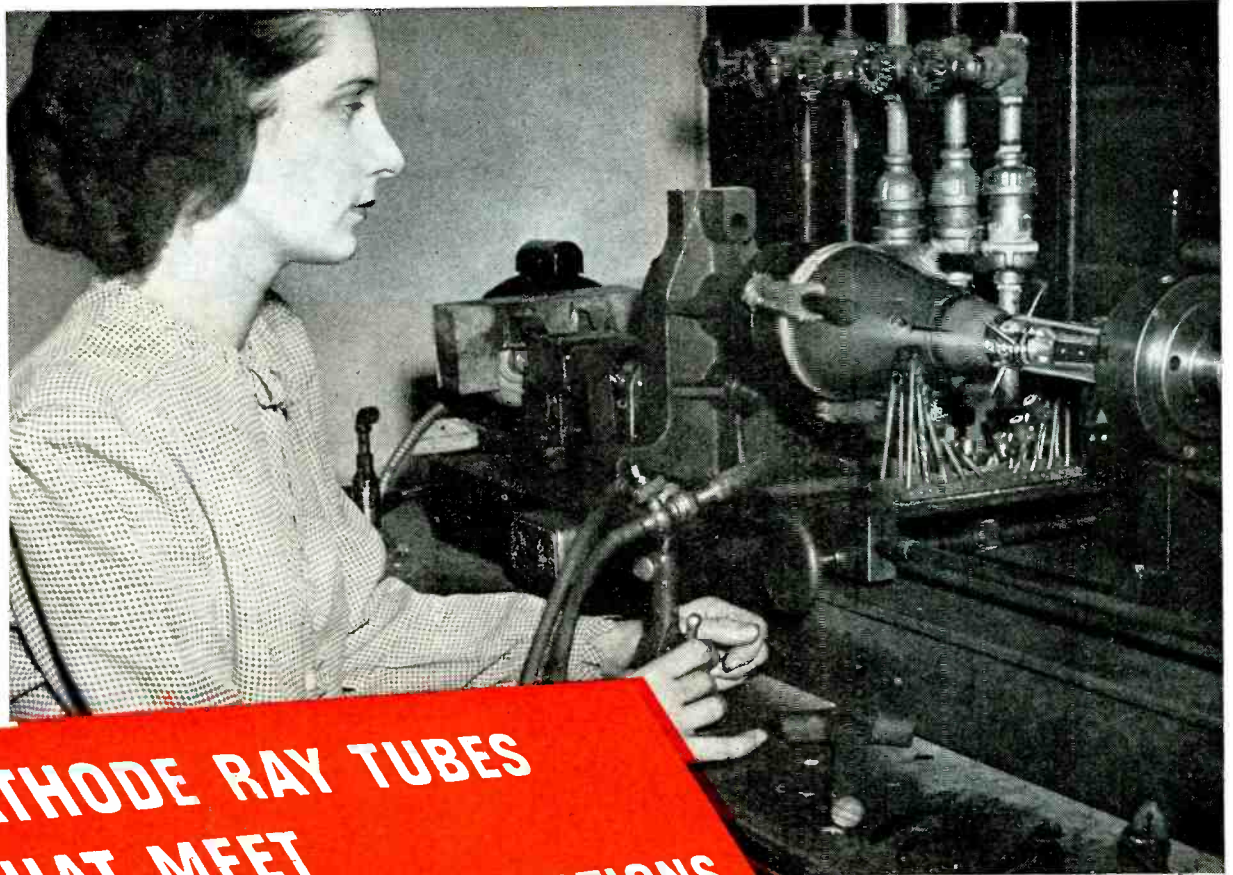

## CATHODE RAY TUBES THAT MEET EXACTING SPECIFICATIONS

**N**ORTH AMERICAN PHILIPS is one of the few manufacturers of electronic tubes endowed with the skill and experience required for the mass production of the 5JP1 and similar cathode ray tubes.

The deflection-plate terminals of these tubes are brought out at the neck of the glass envelope to provide higher insulation and lower lead capacitance at very high frequencies.

In the manufacturing procedure the tubes are cracked at the neck, the deflection-plate leads bent out, and the envelope sections rejoined on a glass-sealing lathe, as illustrated. During this operation the tubes are maintained at a high temperature to prevent the formation of water vapor on the fluorescent screens.

The ability to produce, in volume, NORELCO cathode

ray tubes that meet exacting specifications is the result of experience gained by an organization with a background of over half a century of research and development in the electrical field.

The facilities which North American Philips has applied to the manufacture of electronic tubes in wartime will be immediately available for the post-war production of cathode ray tubes for direct viewing and projection television.



Write today for interesting booklet on "How and Why Cathode-Ray Tubes Work."

*When in New York, be sure to visit our Industrial Electronics Showroom.*

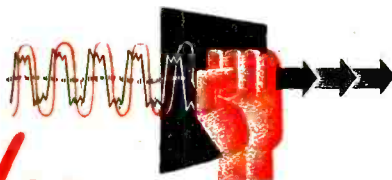

**Norelco** Electronic Products by  
Reg. U. S. Pat. Off.

OTHER PRODUCTS: Quartz Oscillator Plates; Searchray (Industrial X-ray) Apparatus, X-ray Diffraction Apparatus; Medical X-ray Equipment, Tubes and Accessories; Tungsten and Molybdenum Products; Fine Wire; Diamond Dies.

**NORTH AMERICAN PHILIPS COMPANY, INC.**

Dept. D-9, 100 East 42nd Street, New York 17, N. Y.

Factories in Dobbs Ferry, N. Y.; Mount Vernon, N. Y. (Metalix Div.); Lewiston, Me. (Elmet Div.)

**CATHODE RAY TUBE  
PRODUCTION AT RAULAND**



**Sealing on tube neck**

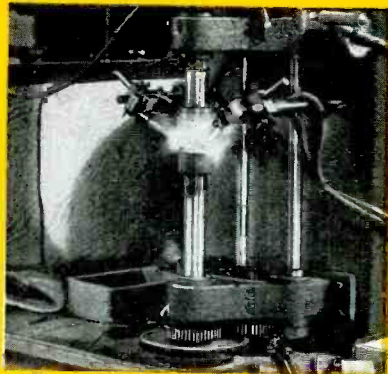

**Manufacturing header**

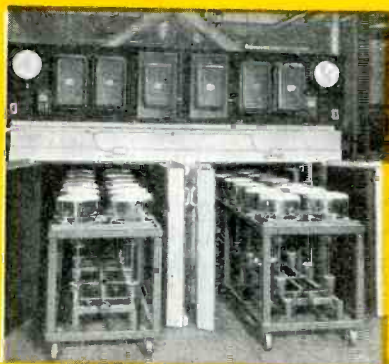

**Baking screens and wall coating**

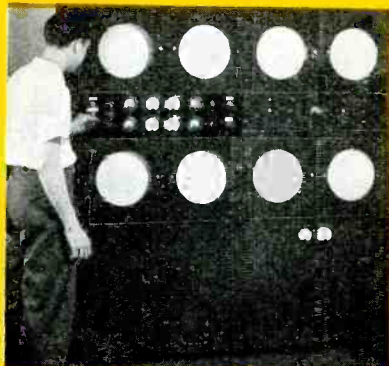

**Life-testing tubes**



EVANS SIGNAL LABORATORY,  
Belmar, New Jersey.  
One of the units of \*SCEL  
\*Signal Corps Engineering Laboratories



War demands converted Electronic Science into a governmental weapon of supreme importance. In the development of Signalling devices, Television, Oscilloscopes and a rapidly increasing group of electronic control equipment, cathode ray tubes were a prime necessity. Since RAULAND has been known as a pioneer in cathode ray tubes, particularly in projection types, it was perhaps natural that the U. S. Signal Corps turned to this organization for tubes to meet entirely new objectives.



This cooperation with the Signal Corps is significant in itself. Physicists and engineers of RAULAND Laboratories are constantly called upon to create cathode ray tubes to meet many new and varied uses for the powerful electronic forces they harness. It is in such delicate problems of research and precision production that RAULAND engineering staff and trained craftsmen excel . . . and will be available for full collaboration with postwar industry, especially in Television.



**RADIO . . . COMMUNICATIONS . . . TELEVISION . .**



★ **First in War**

★ **First in Peace**

**AS THE HEART OF TELEVISION**

**RAULAND  
ELECTRONIC TUBE DIVISION**

Producers of the famous VISITRON Phototubes, for every application and every make of sound-on-film equipment ★ Special-purpose phototubes for all industrial applications ★ Developers of the RAULAND Cathode Ray Tube for Television—to be heart and brain of the coming Television equipment, projecting events as they occur on full size, 15 foot x 20 foot theatre screens ★ Other RAULAND Cathode Ray Tubes include applications for postwar electronics.

*Electroneering is our business*

**Rauland**

**THE RAULAND CORPORATION, CHICAGO 41, ILL.**

**SOUND**

**RADAR**

**It's NEW! It's RUGGED!**

**304-H**

*Gammatron*

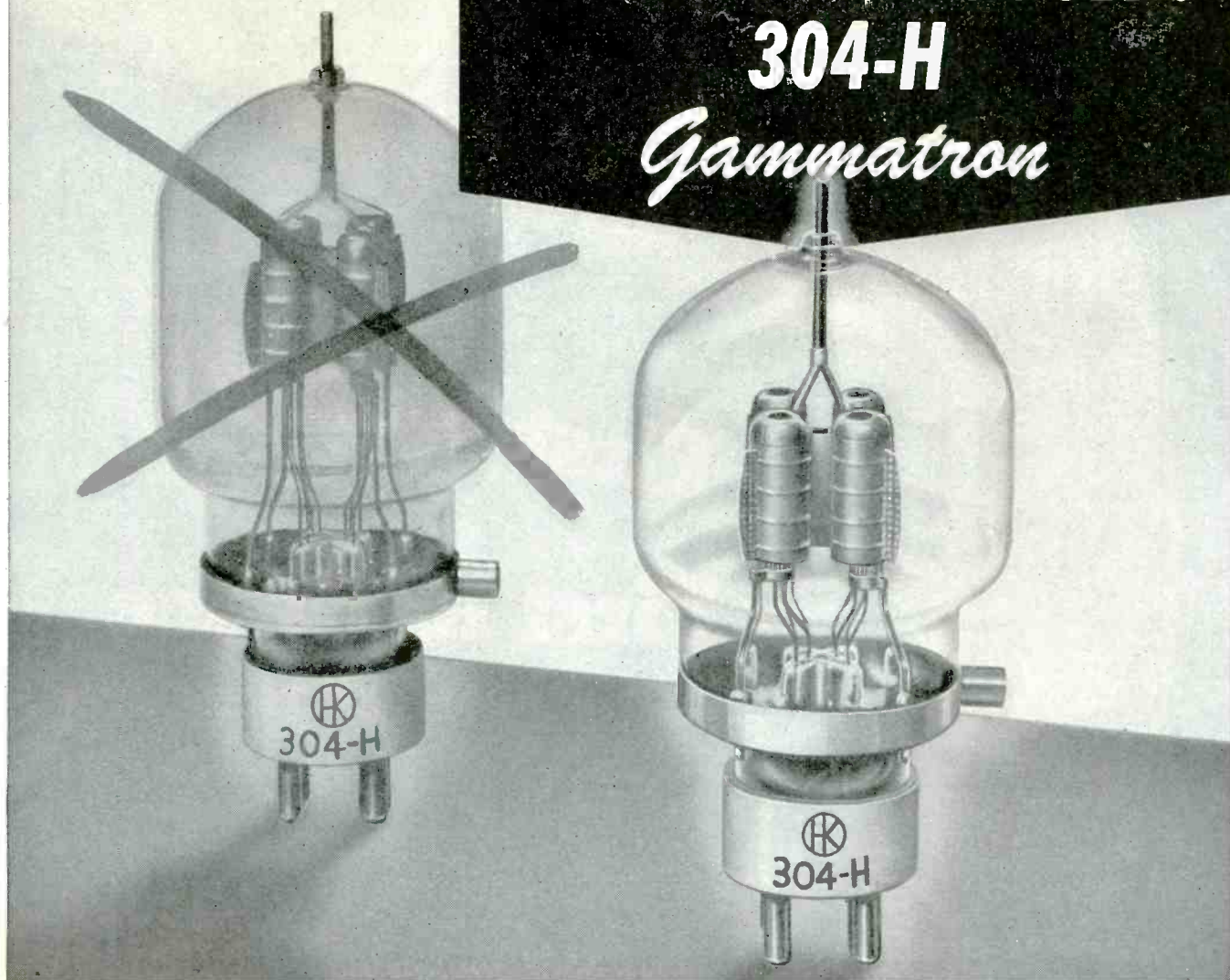

## **Here's a low voltage—high current tube with superior mechanical strength!**

Heintz and Kaufman engineers have developed the new 304-H Gammatron in response to the demand for a low voltage—high current tube possessing greater mechanical strength than the earlier type.

Short, stocky construction and other improvements give the new 304-H a degree of ruggedness which will surpass your expectations. Moreover, this added strength has been achieved without the use of internal insulators.

Although we designed this new Gammatron primarily for ability to withstand bumps, shocks and vibration, certain electrical improvements have also been obtained. The result is a tube

which will have widespread use in electronic heating applications, and as a gate or keyer tube. Its ruggedness, and consequent longer life, materially reduces operating costs.

For data on the electrical characteristics and price of the 304-H Gammatron, please write to

**HEINTZ AND KAUFMAN LTD.**  
SOUTH SAN FRANCISCO • CALIFORNIA

KEEP BUYING  WAR BONDS

*Gammatron Tubes*

Export Agents: M. SIMON & SON CO., INC.  
25 WARREN STREET, NEW YORK CITY, N. Y.

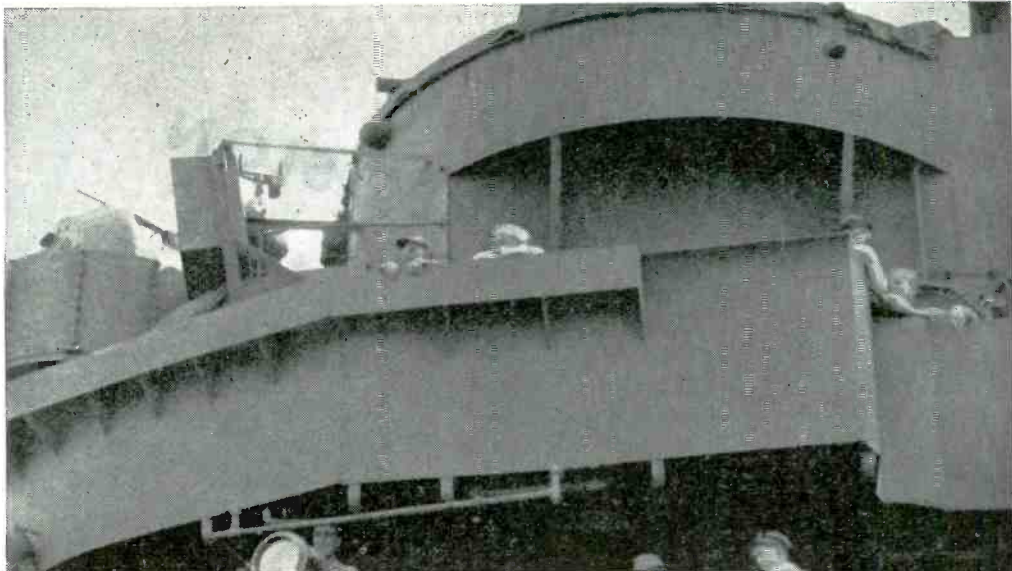

# **MEC-RAD** ELECTRONIC COMPONENTS

## Helped Roll Up This Impressive Score

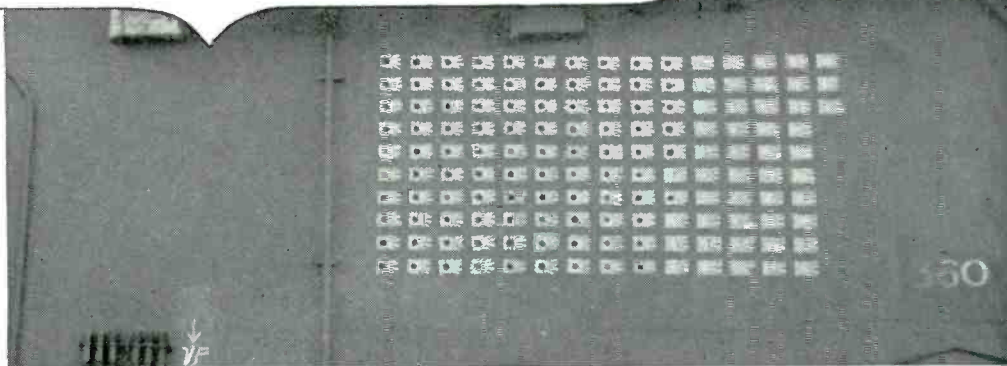

Our remarkable record in the air over the Pacific has been due in large part to the ingenious electronic devices with which our flat-tops are equipped. Mec-Rad makes certain vital mechanical and electro-mechanical components for these devices, and Uncle Sam has first call to our production facilities—as long as he requires them.

Our work includes “fancy brass plumbing” of all types involving soft and hard soldering, close tolerances, precision machining, careful assembly and finishes ranging from lacquer to silver and rhodium plating. After the war our specialized facilities will be available to the electronic industry for peacetime needs. Our engineering “know-how” is at your disposal now to help you with your post-war plans.

Each “Rising Sun” insignia represents a Jap plane downed by the guns and planes of this aircraft carrier—Official U. S. Navy Photograph.

# **MEC-RAD**

## **DIVISION-BLACK INDUSTRIES**

1400 EAST 22ND STREET ★ CLEVELAND 17, OHIO

# BACKGROUND of PRECISION

**L**AATEST time-saving equipment! Skilled craftsmen! Highly specialized engineering personnel! This is why we say, "Let us supply your needs for Housings, Cabinets, Panels and Shelf Assemblies." What we are doing for many other outstanding companies in the radio-electronics field, we would like to do for you.

Behind these products are twenty-five years of experience in the fabrication of steel, stainless steel and aluminum. That's why you can depend on them for accuracy—for apertures that register perfectly—for holes that will always be in the same position whether you order a hundred or thousands of pieces.

If you are looking for a dependable source of supply at prices that will enable you to meet keen postwar competition, send us your blueprints or specifications.

*Steel Age*

Count on  
**CORRY-JAMESTOWN**  
for PRECISION

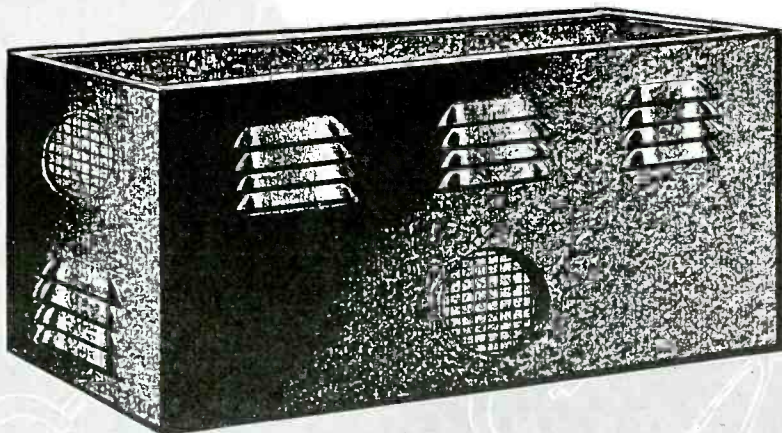

**HOUSINGS • CABINETS • PANELS • SHELF ASSEMBLIES**

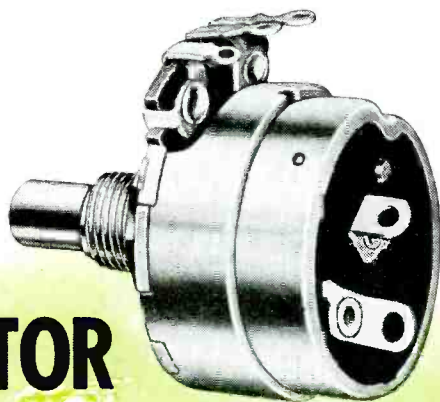

SERIES AC-35  
1 1/2 times actual size

# A VARIABLE RESISTOR

*engineered for* **YOUR application**

All over the world, electronic engineers have found that the safest way to make sure of getting exactly the right variable resistor, is to hand that responsibility over to CTS.

Before starting production on a new part number, CTS always makes up and submits samples immediately, so as to be absolutely certain that the unit will be electrically and mechanically right for its particular job.

Following the maxim—"Be sure you're right, then go ahead" has saved many a CTS client from costly delays. When the order is delivered it will be exactly right—and what's more, it will be *delivered when promised*.

Profit by this CTS service and dependability the next time you need variable resistors.

VARIABLE RESISTORS  
PLUGS AND JACKS



SWITCHES • RINGERS  
TELEPHONE GENERATORS

**CHICAGO TELEPHONE SUPPLY**  
*Company*

ELKHART • INDIANA

#### REPRESENTATIVES

R. W. Farris Co.  
406 West Thirty-fourth Street  
Kansas City 2, Missouri  
Phone: Logan 7495

Frank A. Emmet Co.  
2837 West Pico Boulevard  
Los Angeles 6, California  
Phone: Rochester 9111

#### BRANCH OFFICES

S. J. Hutchinson, Jr.  
401 North Broad Street  
Philadelphia 8, Pennsylvania  
Phone: Walnut 5389

#### IN CANADA

C. C. Meredith & Co.  
Streetsville, Ontario

#### IN ENGLAND

Chicago Telephone Supply Co.  
St. John's Woods  
103 Grove End Gardens  
London, N. W. 8, England

#### IN SOUTH AMERICA

Jose Luis Pontet  
Cordoba 1472  
Buenos Aires, Argentina  
South America

Masculina 2624  
Montevideo, Uruguay  
South America

Avda. Conselheira Rodrigues  
Alves 1057  
Villa Moriana  
Sao Paulo, Brazil  
South America

*Manufacturers of Quality Electro-Mechanical Components Since 1896*

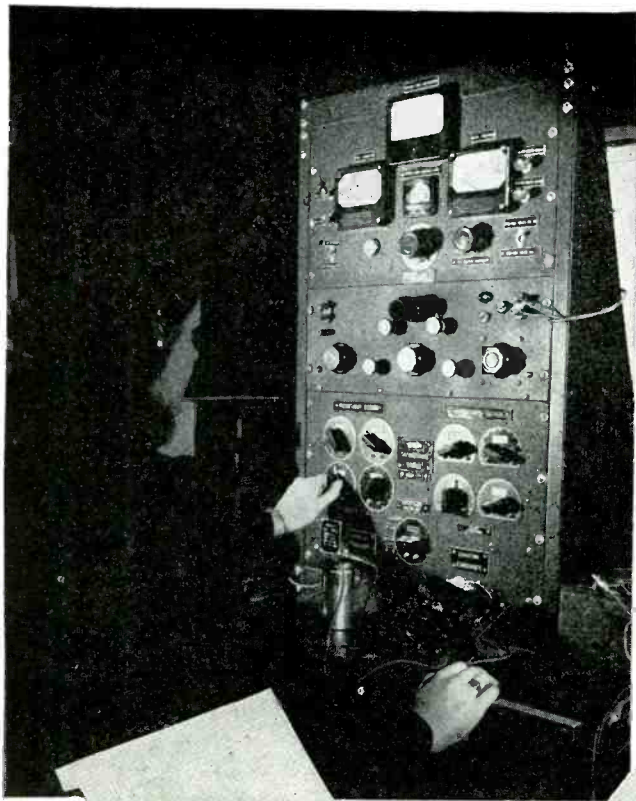

An Aerovox capacitance bridge for measuring capacitance, equivalent series resistance, leakage and other electrical characteristics of electrolytics.

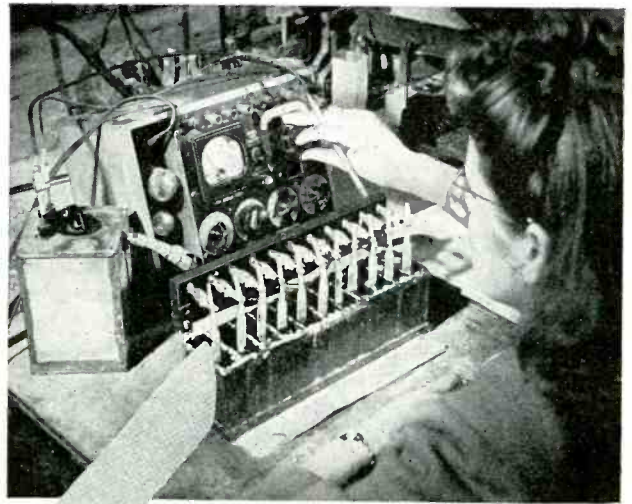

Obtaining the characteristics of aluminum foil samples in order to insure uniform Aerovox quality of each unit throughout production.

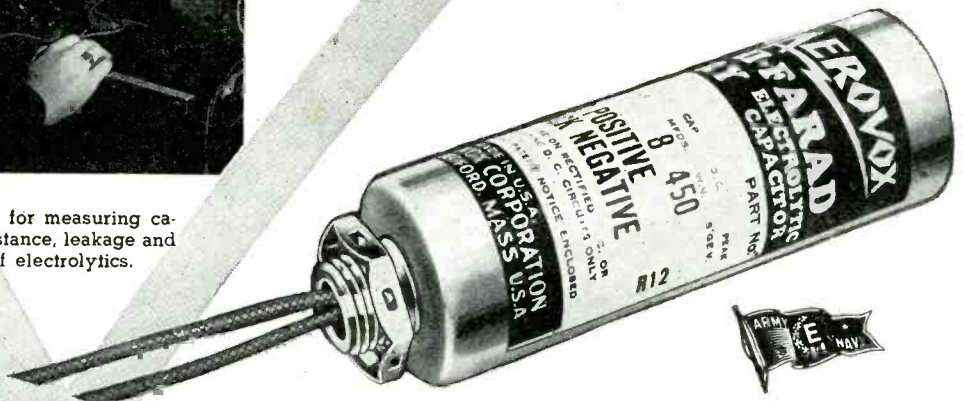

✓✓✓✓✓ from **START to FINISH** insures **AEROVOX**  
**CAPACITOR** *Craftsmanship*

● Inspection—especially when backed by critical instrumentation—insures Aerovox Capacitor Craftsmanship.

With Aerovox electrolytics, for example, production is checked from *start to finish*—from the pre-checking of each constituent material used in the production of electrolytics, to the checking of completed units for their electrical and physical characteristics.

Because of the extra-critical inspection standards, most of the test equipment is designed by Aerovox

engineers and built in their own engineering laboratories. Hundreds of such exclusive Aerovox instruments are in daily use on the production line— instruments seldom seen outside a laboratory— mounting guard at every step from raw material to finished product.

It is such outstanding inspection routine, along with skilled and conscientious workmanship, plus engineering judgment, that accounts for that widely recognized Aerovox Capacitor Craftsmanship.

● Literature on request.



*Capacitors*

**INDIVIDUALLY TESTED**

AEROVOX CORPORATION, NEW BEDFORD, MASS., U. S. A.

SALES OFFICES IN ALL PRINCIPAL CITIES

Export: 13 E. 40 ST., NEW YORK 16, N. Y. • Cable: 'ARLAB' • In Canada: AEROVOX CANADA LTD., HAMILTON, ONT.



# WHEN THE INSULATION

# GOES -



**BH SPECIAL TREATED FIBERGLAS SLEEVING**  
Tops in Electric Irons!

- Won't Fray When Cut
- Flexible and Strong
- Non-Burning to 1200°F!



## YOUR TROUBLE STARTS!

**W**HAT does it mean to *you* when Mrs. Smith's electric iron goes *phht*? If electrical insulation is a part of *your* product, whether it's appliance, radio or electrical equipment, you, like the iron manufacturer, run this *risk*. The risk of insulation failure—of inconveniencing customers, jeopardizing good will, and possibly losing sales.

Since your product's performance may depend on a few cents worth of insulation, be sure to use the best. Assure trouble-free service with BH Fiberglas Sleeveing, the *original* non-fraying, non-stiffening, non-burning Fiberglas sleeveing.

An exclusive BH process combines *permanent* freedom from hardening, cracking or rotting with the many advantages of Fiberglas — including high dielectric and tensile strength, resistance to moisture, oil, grease and most chemicals.

Severest wartime uses prove beyond question the superior qualities of all three BH Fiberglas Sleeveings in electrical applications for home and industry. One of them may fit your needs to a "T"—*plus!* Write for free BH samples today and put them to the toughest tests your product can dish out!

### 3 GREAT BH FIBERGLAS SLEEVINGS—EACH 3 WAYS BETTER!



**NON-STIFFENING\***



**NON-FRAYING\***



**NON-BURNING\***



**BH EXTRA FLEXIBLE FIBERGLAS SLEEVING • BH SPECIAL TREATED FIBERGLAS SLEEVING  
BEN-HAR COATED FIBERGLAS SLEEVING**

\*Ask for sample folder giving degree above characteristics are combined in these three sleeveings. All standard sizes and colors—available in standard 36-in. lengths and 500-ft. coils.



ALSO SLOW-BURNING IMPREGNATED MAGNETO TUBING • SLOW-BURNING FLEXIBLE VARNISHED TUBING • SATURATED SLEEVING • A. S. T. M. SPECIFICATIONS

**BENTLEY, HARRIS MANUFACTURING CO.**

**Dept. I, Conshohocken, Penna.**

# FERRIS INSTRUMENTS

## A LASTING INVESTMENT

The usefulness of Ferris instruments is being constantly extended and improved by the introduction of new devices such as shown below:



**MODEL  
32XA8  
PROBE  
CALIBRATION  
COIL**

The above accessory is for the purpose of calibrating the Model 32XA6 Hand Loop Exploring Prod thereby permitting its use for standardized measurements.

### **ULTRA HIGH FREQUENCY SIGNAL GENERATOR OUTPUT TERMINATION**

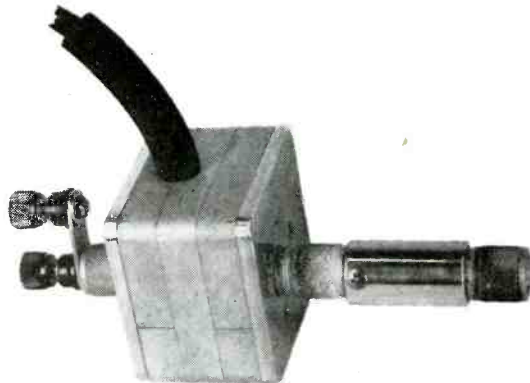

A new output termination for U.H.F. work permitting more convenient and accurate work. Also a shielded dummy antenna with changeable resistance values for use with this termination. Write for details.

**FERRIS**

**FERRIS INSTRUMENT  
COMPANY**

110 CORNELIA STREET, BOONTON, N. J.

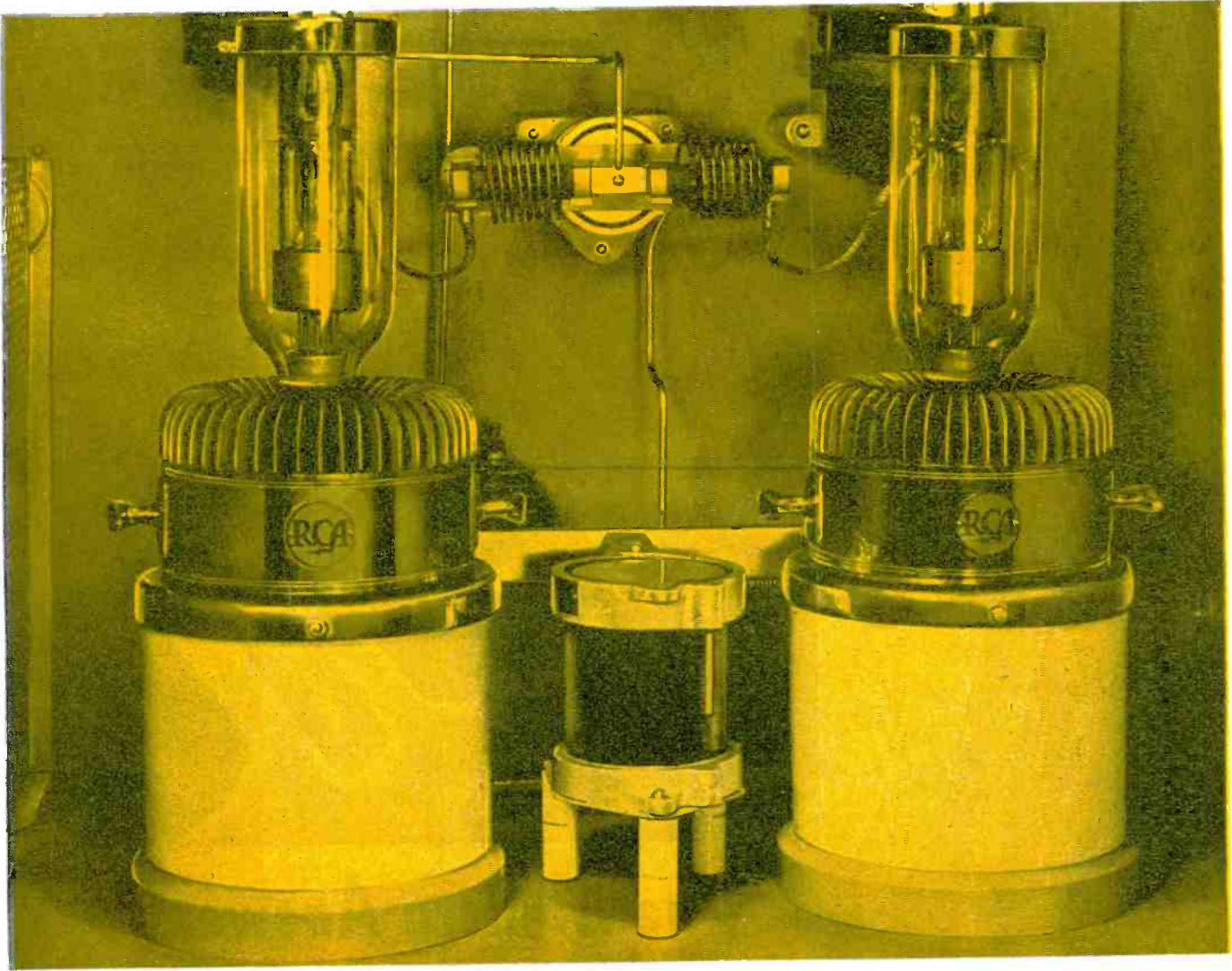

## *FARADON Capacitors for Industrial Oscillators*

FOR 25 years, Faradon Capacitors have been used in outstanding communication and broadcast equipment built by RCA and other well-known manufacturers. Today, capacitors are finding new uses in electronic power generators, which are serving industry in many ways.

The reliability of Faradon Condensers, the wide range of sizes available, and the facility with which

they can be adapted to design requirements, make them a natural choice for all such applications.

For information on Faradon Capacitors for any purpose, write to Faradon Condenser Section, Dept. BB125, Radio Corporation of America, Camden, New Jersey.

At right. *RCA 15-B Electronic Power Generator, used for preheating of plastic materials, gluing of laminated propellers, the processing of rayon yarns and for numerous other purposes.*



BUY MORE WAR BONDS



# RADIO CORPORATION OF AMERICA

RCA VICTOR DIVISION • CAMDEN, N. J.

In Canada, RCA VICTOR COMPANY LIMITED, Montreal

# IRON SLEEVE CORES

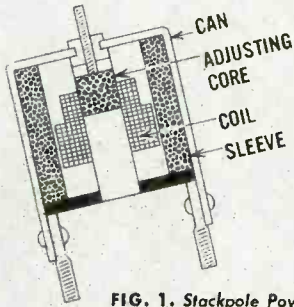

FIG. 1. Stackpole Powdered Iron Sleeve and Core used for Diode Transformer (I-F); Antenna, Oscillator, or Filter Coils, etc.

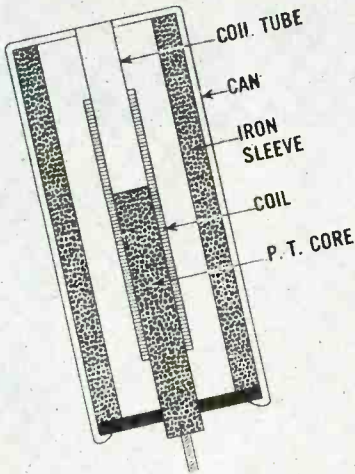

FIG. 2. Grade SK1 core and powdered iron sleeve (.790 O. D. x 1 1/2" long) used with permeability tuning in auto radio receiver.

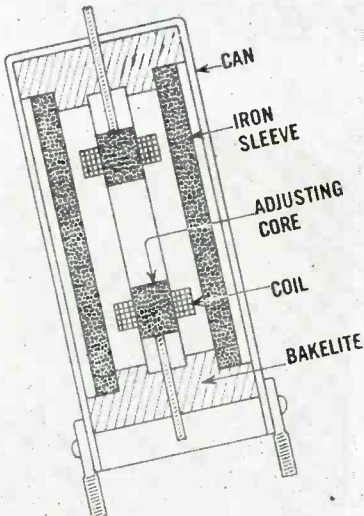
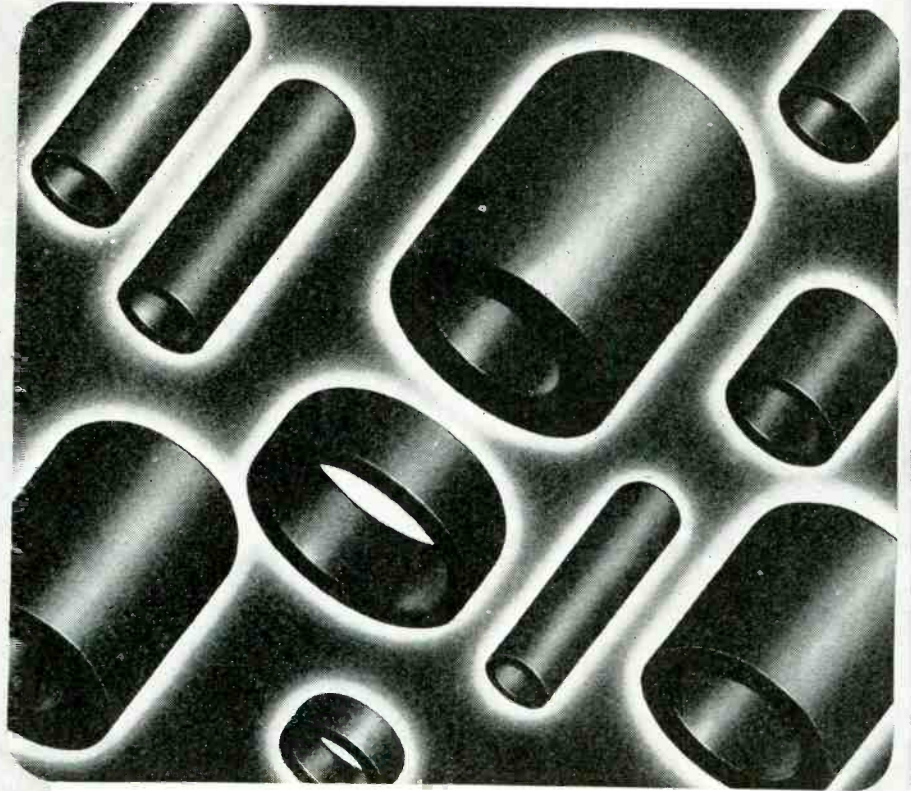

FIG. 3. Two Stackpole cores and powdered iron sleeve used in a double tuned I-F transformer application.



## The Modern Answer to Better Coils in Less Space

BY USE of Stackpole Sleeve Cores, much smaller cans of any material may be used to provide Q that is equal to or better than that of conventional coils and cans. Thus they pave the way to an exceptionally high order of tuning unit efficiency in greatly reduced size. A few of many design possibilities are indicated in the accompanying sketches.

Beside supplying additional electrostatic and electromagnetic protection over that provided by the can alone, sleeve cores result in making the can itself smaller, less critical and less costly. Inexpensive die cast lead cans, for instance, may be used instead of aluminum. In some cases, it may not even be necessary to use a can.

STACKPOLE CARBON COMPANY, ST. MARYS, PA.

EXPORT: Stackpole Carbon Co., 254 W. 34th St., New York 1, N. Y., U. S. A.

# STACKPOLE

ELECTRICAL BRUSHES AND CONTACTS (All carbon, graphite, metal and composition types) • RARE METAL CONTACTS • WELDING CARBONS • BRAZING TIPS AND BLOCKS • PACKING, PISTON, AND SEAL RINGS • CARBON REGULATOR DISCS • MOLDED METAL COMPONENTS, ETC.

# Runzel

CORDS • WIRES CABLES

**IS READY**



This battery of cord braiding machines, carefully watched over by especially trained inspectors, is one of the typical operations necessary to making a good product.



*with*  
**THE PLANT • THE PERSONNEL**  
**THE EQUIPMENT**  
*for Fast Service to the*  
**COIN MACHINE • RADIO**  
**TELEPHONE • ELECTRONIC**  
**AND ALLIED INDUSTRIES**



Soldering terminals on cords requires not only skill, but painstaking effort and patience, supplied by these trained operators.

## **RUNZEL CORD & WIRE CO.**

4723-31 MONTROSE AVE. • CHICAGO 41, ILLINOIS

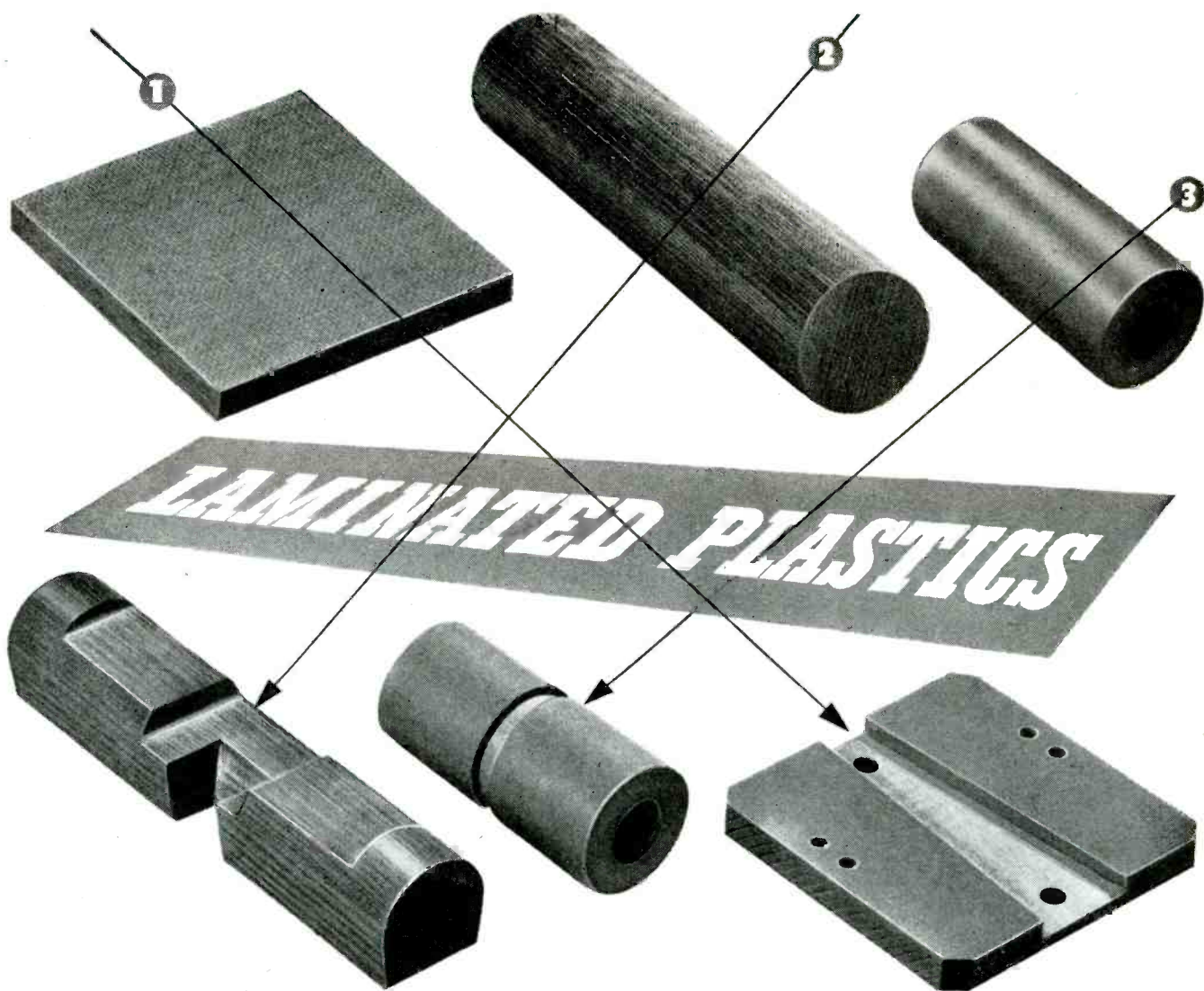

## Thousands of Fabricated Parts from Taylor's Sheets, Rods, Tubes

① One of several parts for an artificial leg, which is sawed, milled and drilled from a flat sheet of Phenol Fibre.

② Hinge support blocks for the P-51 Mustang fighter planes' elevator trim tabs were created and designed by Taylor engineers.

③ Switch spacers, made from tubes of Phenol Fibre, are quickly and accurately finished on a Taylor automatic screw machine.

From sheets, rods, and tubes of Phenol Fibre or Vulcanized Fibre, Taylor makes thousands of different fabricated parts, turning them out by the millions and doing it quickly, accurately, and economically.

Almost every one of these parts is specially designed for a special purpose and calls for a laminated plastic with special characteristics. Their common feature of light weight and great strength, combined with dielectrical properties, is unexcelled by any other material.

Taylor also has a stock of standard tools for turning out such parts as plain washers and shoulder bushings, in so many different sizes that the chances are good that the size you need is in stock and your fabricated part can therefore be made more quickly and more inexpensively.

Whatever your problem, our engineers will gladly tell you, without obligation, exactly what Taylor Laminated Plastics can contribute to its solution. Write us today, sending sketch or blueprint.

# TAYLOR FIBRE COMPANY

**LAMINATED PLASTICS:** PHENOL FIBRE • VULCANIZED FIBRE • Sheets, Rods, Tubes, and Fabricated Parts  
 NORRISTOWN, PENNSYLVANIA • OFFICES IN PRINCIPAL CITIES • PACIFIC COAST HEADQUARTERS: 544 S. SAN PEDRO ST., LOS ANGELES 13



# SCOVILL DEvised A NEW SCHEDULE FOR TRANSMITTER TUBE ANODES

*... and put them on the air faster*

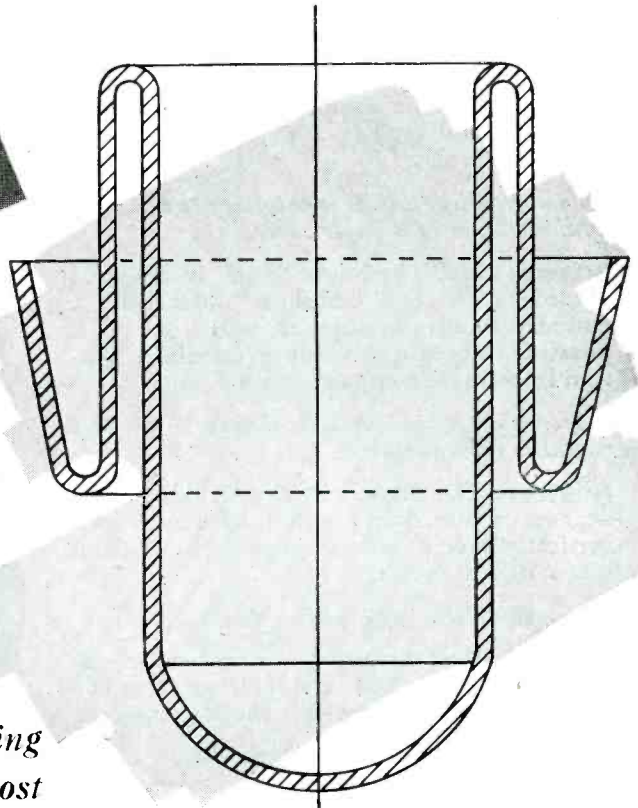

## *How Scovill Electronents\* meet exacting specifications ... often at lower cost*

This anode for a radio broadcasting tube involved several difficult problems. Specifications called for a seamless, one-piece, pure oxygen-free copper shell ... free from imperfections. Dimensions: length  $6\frac{1}{64}$ "', I.D. 3"', diameter across hollow flanged section  $5\frac{61}{64}$ "', average wall thickness .090". That hollow flanged section was no cinch. But an ingenious metal-working schedule took care of that.

Specifications were met 100%... and costs were surprisingly low.

Whether your electronic equipment requires small components or large assemblies, you, too, can save time, trouble and money by calling on Scovill's design ingenuity and versatility in all metals and all metal-working techniques. To learn why Scovill is in a position to give you impartial advice about whether to forge, draw,

stamp or machine your Electronents\*, send for literature. Fill in the coupon below and mail it today.

\*Electronents = Electronic Components



Please send me a free copy of "Masters of Metal" booklet describing your facilities. I am interested in the ELECTRONENT\* applications checked.

- |  |                                      |  |
|--|--------------------------------------|--|
| <input type="checkbox"/> Batteries       | <input type="checkbox"/> Dials       | <input type="checkbox"/> Panels            |
| <input type="checkbox"/> Record Changers | <input type="checkbox"/> Escutcheons | <input type="checkbox"/> Sockets           |
| <input type="checkbox"/> Clips           | <input type="checkbox"/> Jacks       | <input type="checkbox"/> Stampings (misc.) |
| <input type="checkbox"/> Condensers      | <input type="checkbox"/> Lugs        | <input type="checkbox"/> Tubes             |

Other applications .....

### SCOVILL MANUFACTURING COMPANY

Electronic Division  
23 Mill Street, Waterbury 91, Connecticut

Name .....

Company .....

Address .....

# Answers to your Questions about the SHURE "556" Super-Cardioid Broadcast Dynamic

Q. *What is meant by Super-Cardioid?*

**Answer:** Super-Cardioid is an improvement on the cardioid (heart-shaped) pickup pattern, which makes it even more unidirectional. "Super-Cardioid" reduces pickup of random noises by 73% as compared to 67% for the Cardioid, and yet has a wide pickup angle across the front.

Q. *To accomplish this, is it necessary to have two Microphones in a single case?*

**Answer:** No. The Shure "556" is designed according to the "Uniphase" principle, a patented Shure development which makes it possible to obtain the "Super-Cardioid" pattern in a single compact, rugged unit.

Q. *Over what range does the Shure "556" give quality reproduction?*

**Answer:** The Shure "556" provides a high degree of directivity, both horizontally and vertically over a wide frequency range from 40 to 10,000 cycles.

Q. *Does the Shure "556" reduce feedback?*

**Answer:** Yes! Reflected sounds and "spill-over" from loud speakers entering from the rear are cancelled out within the Microphone.

Q. *Can the Shure "556" be used outdoors?*

**Answer:** Yes. It is insensitive to wind and will withstand heat and humidity. The low impedance models may be used at practically unlimited distances from the amplifier.

Q. *Can the Shure "556" be used for Studio Broadcasting?*

**Answer:** More than 750 Radio Broadcast Stations in the United States and Canada use the Shure "556" in their studios. Because it can be placed with its back to the wall without picking up reflected sounds or echoes, it facilitates Microphone placement.

*Model 556A for 35-50 Ohm circuits—  
LIST PRICE \$75*

*Model 556B for 200-600 Ohm circuits—  
LIST PRICE \$75*

## SHURE BROTHERS

*Designers and Manufacturers of Microphones  
and Acoustic Devices*

225 West Huron Street, Chicago 10, Illinois

CABLE ADDRESS: SHURE MICRO





*If you make or use  
electronic equipment  
for radio transmitting or  
industrial purposes...*

**The story of the DYNAMAX is of utmost significance to you**

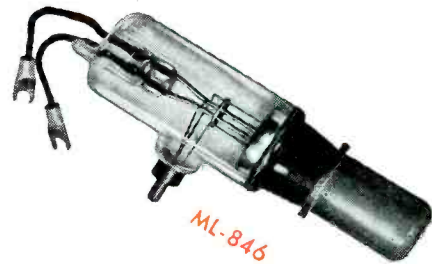
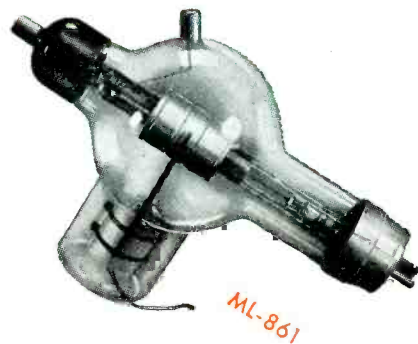
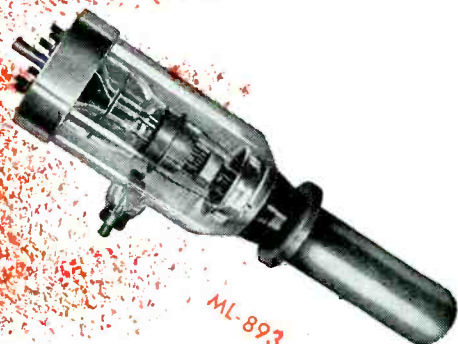

**W**HEN first announced, in 1938, the Machlett Dynamax represented the solution of the most difficult problems ever encountered in electron tube manufacture — paralleled only by the Machlett VM-1, the first precision, sealed-off, 2,000,000-volt dc tube.

The Dynamax was designed to meet the demand for a dependable, high-capacity X-ray tube that would give much sharper definition under the most adverse conditions. The desired results could be obtained only by using a very small focal spot, and an electron beam of high energy, 100 KV, .5 amp. Concentrating so much energy on a small spot meant destruction of target and tube unless the heat could be dissipated. Rotating the target was found to be the most effective means of protection, but this produced a much greater problem, that of lubricating the motor bearings inside the envelope without impairing the vacuum through distillation of the lubricant. A novel method of coating the bearings with a film of pure metallic silver was developed by Machlett engineers, with the result that the weakest spot became the strongest.

Today, Machlett rotating-anode tubes give over 200,000 exposures, over ten times the normal life expectancy of X-ray tubes of only a few years ago, and more than twice that of present-day conventional stationary-anode tubes! This is the preferred type for use in mass health surveys and busy institutions where the load is too great and too constant for any other tube. You will be interested in the full story of the Dynamax — write for your copy today; it will be sent with our compliments.

True enough, the Dynamax is an X-ray tube — but all electron tubes are brothers under the skin. The engineering talent, the techniques and the manufacturing skill which produced the first really successful rotating-anode tube are the same that now guarantee the performance and advanced features of all Machlett electron tubes, for all purposes, whether in the fields of radio or industry. It will pay you to use this background of electron tube engineering and production skill by choosing a Machlett when you need an oscillator, amplifier, modulator or rectifier. Machlett Laboratories, Inc., Springdale, Connecticut.

**MACHLETT**

APPLIES TO RADIO AND INDUSTRIAL USES  
ITS **48** YEARS OF ELECTRON-TUBE EXPERIENCE

where **PLASTICS** belong

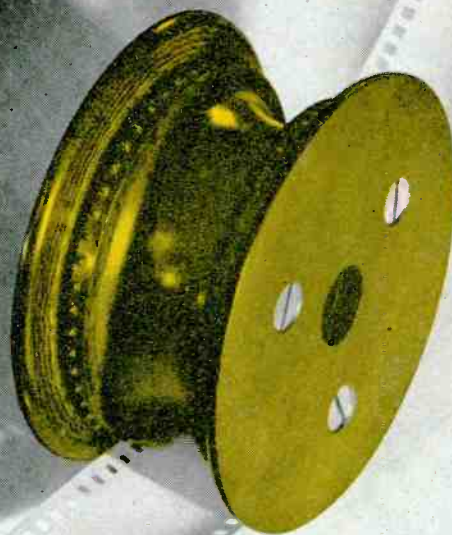

## Using Corrosion Resistance, Strength, and Machinability

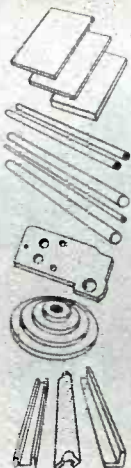

SHEETS

RODS

TUBES

FABRICATED PARTS

MOLDED-MACERATED

MOLDED-LAMINATED

**M**OVIE FILM carriers are an excellent example of using plastics where plastics belong.

The film carrier illustrated is only one of many types made from Synthane laminated plastics. Synthane is well-suited for the job because it stoutly resists the corrosive action of developing solutions.

The teeth, though small, must be strong and accurately indexed. They are easily milled from Synthane.

If you have any application for which

laminated plastics seems to be indicated, let us know about it—*before* you design, if possible.

Our development engineers want to help you fit the job for plastics and fit the plastics for the job. Design, materials and production should be eyed as one problem if performance and costs are to be satisfactory. Synthane's help includes design, selection of the right material, and fabrication by men who know plastics. Synthane Corporation, Oaks, Pa.

SYNTHANE TECHNICAL PLASTICS • DESIGN • MATERIALS • FABRICATION

**SYNTHANE**



# What'll You Have!



Dielectric? Synthane is an excellent electrical insulator. Dielectric strength is high, power factor and dielectric constant low. What makes Synthane the useful dielectric it is, is its strength and the comparative ease with which it can be punched or machined into the variety of parts needed on radio and electrical equipment.



Radio Socket Base



Strength? Synthane seldom is asked to compete with metals and alloys in strength. It is exceptionally strong for its weight and will compare favorably with metals for strength on a weight basis. Synthane is a member of that family of plastics highest in tensile, compressive, flexural and impact strengths.

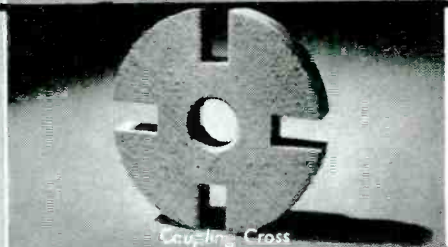

Coupling Cross



Light Weight? One of the most important properties of Synthane is its light weight. Although Synthane weighs only 1/2 as much as aluminum its strength is ample for electrical applications and sufficient for most mechanical uses. Light weight plus other virtues accounts for its wide use in aviation.



Vee Self Pulley



Anti-friction? Two grades of Synthane laminated have anti-friction and anti-wear characteristics built in, due to the incorporation of a special graphite. Available in sheets, rods, tubes and in special shapes and fabricated parts. Possibilities for this material are worth investigating.



Ball Bearing Retainer



Corrosion Resistance? Perhaps you can take advantage of Synthane's immunity to most oils and solvents, Synthane's resistance to various concentrations of acids and salts. Often used because it has longer life per dollar than other materials, including cost of replacement.



Plating Tank Parts

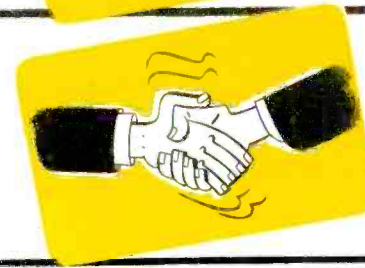

Combination? Are you looking for two, three, four or even more properties combined in one material? Synthane may do the trick. It has all of the advantages above plus hardness, abrasion resistance, stability under temperature or moisture conditions, ease of machining, and many others.



Molded Gears

**SYNTHANE CORPORATION, OAKS, PENNA.**

*Representatives in all principal cities*

Plan your present and future products with Synthane Technical Plastics • Sheets  
Rods • Tubes • Fabricated Parts • Molded-laminated • Molded-macerated

**SYNTHANE**  
S

A detailed illustration of a vacuum tube, likely a radio receiver or transmitter component, is the central focus. It is a glass tube with a metal base and several pins at the bottom. A black scale with white markings and numbers (9, 10, 11, 12, 13, 14, 15, 16, 17, 18, 19) is wrapped around the middle of the tube. In the background, there are stylized clouds and a target symbol on a map, suggesting a military or navigation context.

**clouds have no road signs**

Up where there are no tracks or signposts, bombers wing faultlessly to their target—a tiny speck on the map half-a-thousand miles away. Helping to guide them to their objective are Delco Radio products that harness the magic of high-frequency waves to the functions of communication, navigation, detection and ranging. From compact radio sets to highly intricate radar equipment, these products represent Delco Radio's effective combination of engineering vision—manufacturing precision.

*Keep Buying More War Bonds*

**Delco Radio**  
DIVISION OF  
**GENERAL MOTORS**

# HEAT THAT HITS THE SPOT for Brazing



High frequency current focused by Ajax-Northrup inductor coils right into a joint to be brazed, heats a thin zone of metal so fast that the brazing alloy flows smoothly into all parts of the joint before the rest of the piece can heat up.

Results are better joints, fewer rejects, less scale and distortion, and lower unit heating costs — all at high production-line speeds. Typical work coils and brazing units are shown at the right.

Select long-life, efficient Ajax-Northrup equipment for your induction brazing. High frequency converters are self-tuning, are easy to convert from one job to another, are easy to operate, and give consistent results at low cost. Frequencies range from 20,000 to 60,000 cycles. Capacities are 3, 6, 20 and 40 kw.

Generator-operated equipments, in sizes from 25 kw. up, are for larger jobs at less than 12,000 cycles. Write Ajax for more details on induction brazing.

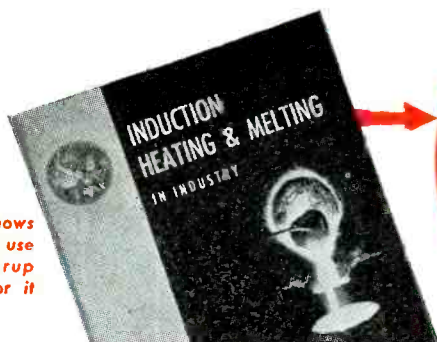
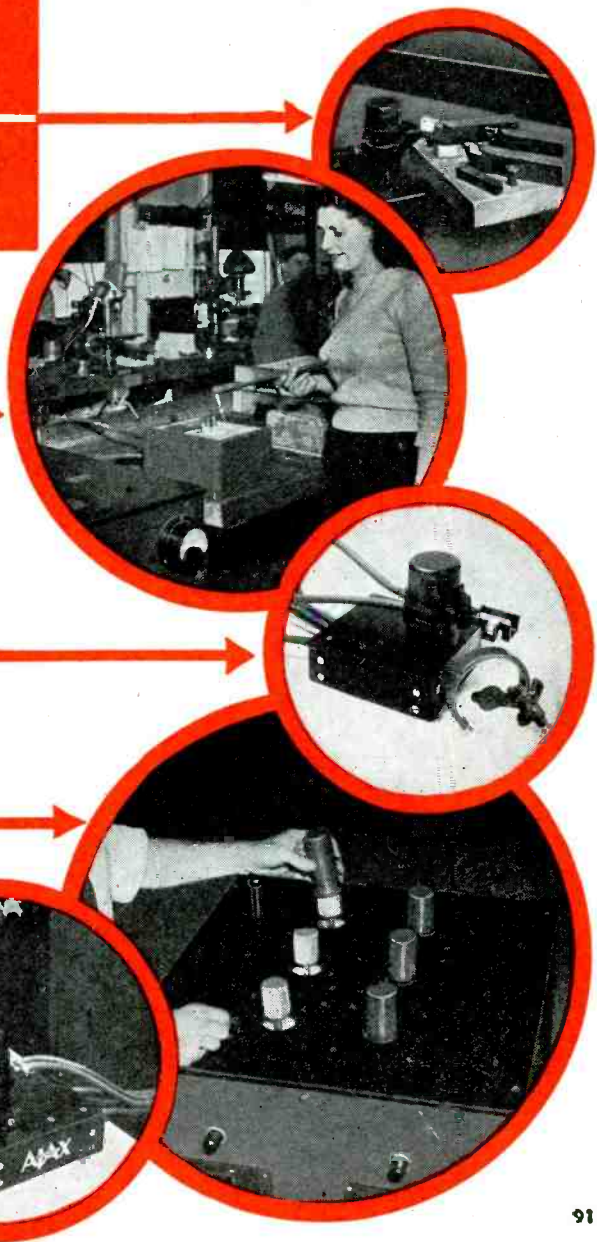

Bulletin 25 shows many ways to use Ajax - Northrup heat. Send for it today.

**AJAX NORTHROP** Since 1916 **AJAX ELECTROTHERMIC CORP., AJAX PARK, TRENTON 5, N. J.**  
**HIGH-FREQUENCY HEATING · MELTING**

AJAX METAL COMPANY, Non-Ferrous Ingot Metals and Alloys for Foundry Use  
AJAX ELECTRIC FURNACE CORP., Ajax-Wyatt Induction Furnaces for Melting  
AJAX ELECTRIC CO., INC. The Ajax-Hultgren Electric Salt Bath Furnace  
AJAX ENGINEERING CORP., Ajax-Tama-Wyatt Aluminum Melting Induction Furnaces

A S S O C I A T E  
C O M P A N I E S



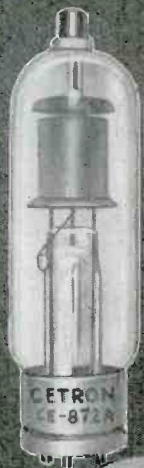
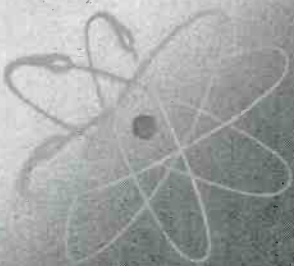

**FROM ONE SOURCE**

**"An Electronic Tube for Every Need"**

# CETRON

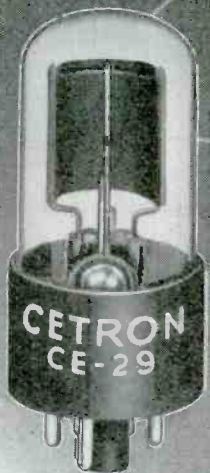

CATALOG SENT  
ON REQUEST



Cetron Rectifiers are available in gas and mercury filled, both full and half wave types in a wide range of ratings.

Cetron Phototubes are produced by us to take care of almost every situation . . . over 50 types, both blue and red sensitivity.

Our long experience and careful production methods can also be of value to you in producing special tubes for special purposes.

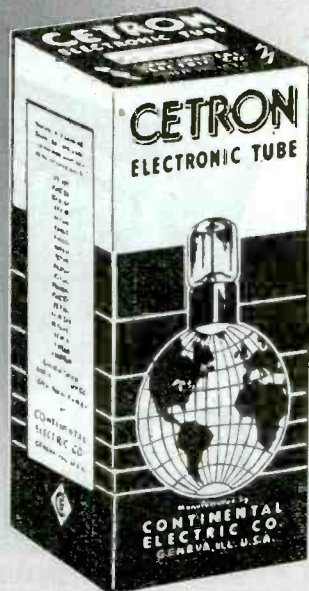

## CONTINENTAL ELECTRIC CO.

CHICAGO OFFICE  
188 W. RANDOLPH ST.

**GENEVA, ILL.**

NEW YORK OFFICE  
265 W. 14th St.

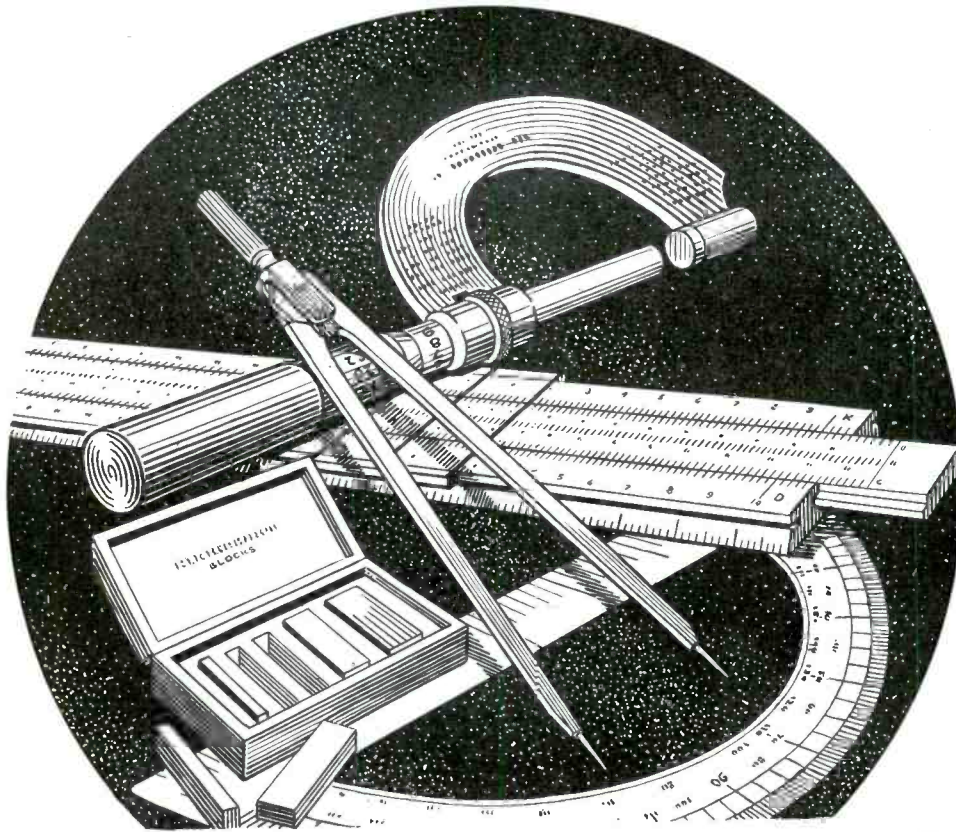

**WE MATCH YOUR STANDARDS**

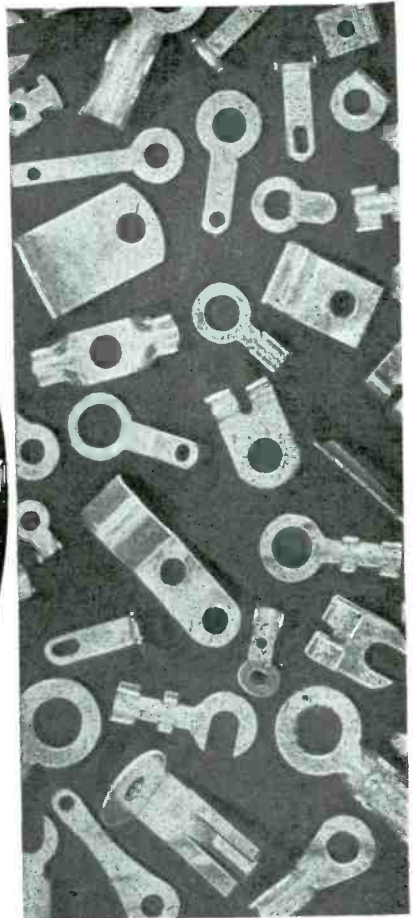

**OF PRECISION**

**I**N THE field of electronics, close tolerances are often imperative. From the drafting board to the finished product the highest precision standards must be maintained.

When you hand us your blue prints for metal stampings you may be sure that the parts we deliver to you will conform to specifications with absolute accuracy. Constant checking by micrometer, snap gauge and other instruments enables us to match your precision standards.

Our tool room is equipped to make dies for your special needs. Odd shaped pieces stamped and formed from strip or wire on high speed machines.

**Let us have your blue prints and specifications.  
Quick response to inquiries.**

**STEWART STAMPING COMPANY**  
630 CENTRAL PARK AVENUE, YONKERS, N. Y.

We carry hundreds of items in stock, to meet practically every installation requirement. All pieces can be furnished in any desired finish.

**HOT TINNING,  
NICKEL, CADMIUM, SILVER  
AND ZINC PLATING**

**REPRESENTATIVES**

LLOYD C. NYMAN  
706-2 Boulevard Bldg.  
Detroit, Mich.

M. L. COHN  
9476 Readcrest Drive  
Beverly Hills, Calif.

F. E. HARTWEG  
800 North Delaware Ave.  
Philadelphia, Pa.

J. L. ROWE  
20 North Wacker Drive  
Room 866. Chicago 6. Ill.

**STEWART**  
**METAL STAMPINGS**  
TERMINALS LUGS BRACKETS CLIPS

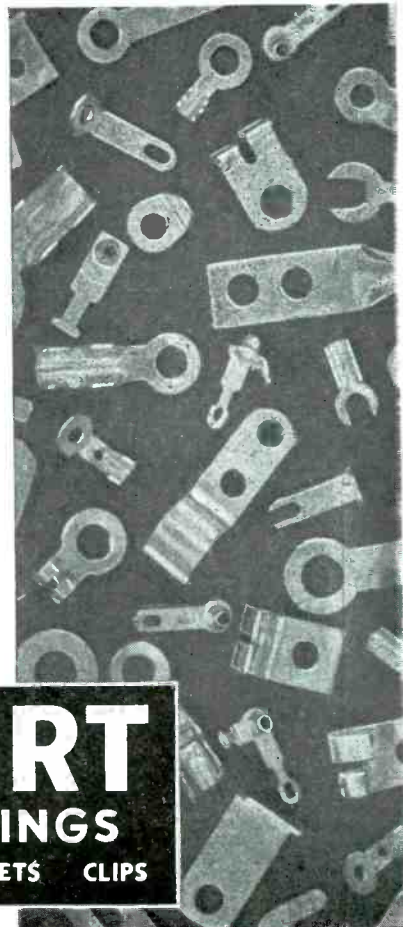

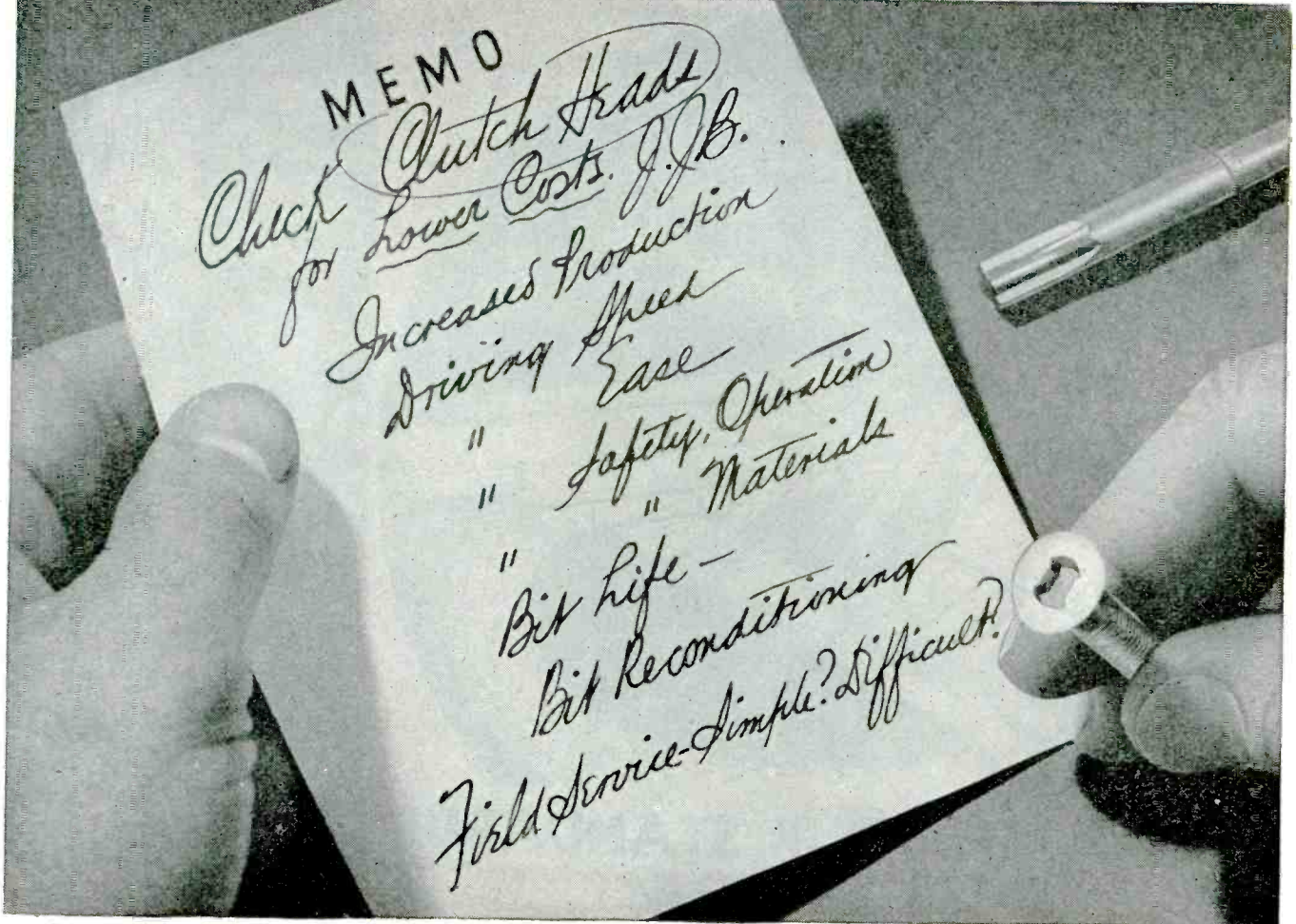

TYPE "A" ASSEMBLY BIT

COMMON SCREWDIVER

## Tighten up for Reconversion

The result will show that CLUTCH HEAD Screws have exclusive features and advantages that out-mode all other screws on the market today . . . each a factor that contributes importantly to the *lower final cost* of assembly and servicing.

**FOR SPEED . . .** Center Pivot entry into the wide roomy Clutch makes straight driving automatic and smooths out slow-down hesitation.

**FOR MORE SPEED . . .** Driving engagement is all-square. Flat sides of bit contact straight walls of Clutch for effortless, therefore easier and faster, drive home. No ride-out as set up by tapered driving. No fatiguing end pressure to combat. No delay replacing reamed screws and chewed-up heads.

**FOR TWO-WAY SAFETY . . .** Automatic dead-center entry and positive torque drive (without ride-out) eliminates the slippage hazard . . . protection against injury to manpower and damage to materials.

**FOR A NEW LOW IN TOOL COST . . .** The rugged Type "A" Bit stands up through long "non-stop" spells, *driving extra thousands of screws* without interruption. Reconditioning to original efficiency requires only a 60-second application of the end surface to a grinding wheel.

### SAMPLE SCREWS AND BIT SENT ON REQUEST

**FOR BREAKING "BOTTLENECKS" . . .**  
A reverse turn of the Type "A" Bit in the Clutch recess forms the Lock-On, uniting screw and bit as a unit for easy one-handed reaching to hard-to-get-at spots. Lock-On is automatically released by normal driving of the screw.

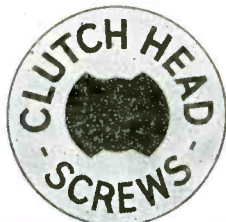

**FOR SIMPLIFIED FIELD SERVICE . . .**  
This is the only modern screw basically designed to operate with an ordinary type screwdriver. With a Type "A" driver, the Lock-On feature permits the withdrawing of screws undamaged and held safely for re-use.

**UNITED SCREW AND BOLT CORPORATION**  
CHICAGO 8      CLEVELAND 2      NEW YORK 7



# One call does it all

...when you buy your electronic tubes  
under the new Westinghouse  
**SURVEY AND SUPPLY PLAN!**

A Westinghouse tube representative will survey your electronic equipment to determine the number and type of each tube, regardless of make, and its estimated life.

Westinghouse tube representatives also will make tube surveys of the other plants in your area to determine the quantity, number and type of tubes required.

Your Westinghouse tube distributor then has an accurate picture of tube requirements of your entire area on which he may base his tube stock. This stock will include all the tubes which your equipment requires, regardless of make.

## **HERE'S WHAT YOU GET!**

A copy of the survey of your equipment.  
A report on the tubes used in your plant.  
Prompt delivery on these tubes from your local Westinghouse tube warehouse.

## **FOR A SURVEY OF YOUR PLANT**

... call your local Westinghouse representative or write Westinghouse Electric Corporation, Lamp Division, Bloomfield, N. J.

©1945, Westinghouse Electric Corporation

# Westinghouse

TUNE IN: John Charles Thomas—Sunday, 2:30 P. M., EWT—NBC  
Ted Malone—Mon. through Fri., 11:45 A. M., EWT—Blue Network

*Electronic Tubes at Work*

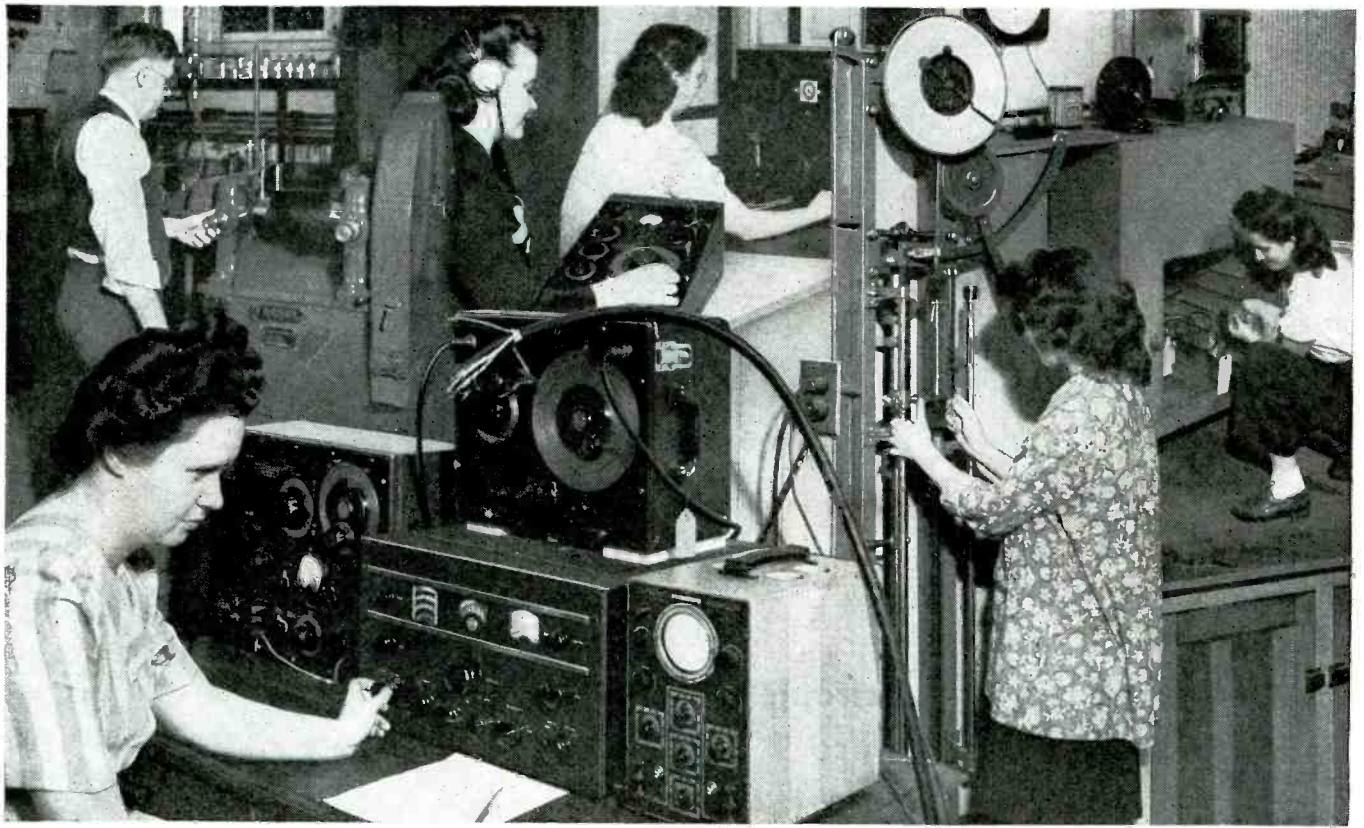

## *This Laboratory Can Help Solve* **YOUR CABLE PROBLEMS**

**P**ICTURED above is a composite view of some of the test equipment in daily use at The Ansonia Electrical Company Laboratories.

This equipment and the personnel, both laboratory and engineering, are constantly on the job controlling production quality of our many specialty cables for Government and industry uses.

These facilities have helped get many special Army and Navy multiconductor cables into production. Some of these cables had never been made before. Some were just too tough for many to handle. Some were conventional cables but their performance characteristics using thermoplastic insulation were either unknown or unproved. After extensive research and careful analysis in our laboratories several types of Ankoseal were developed and successfully applied on these various cables.

Today the electrical values and physical characteristics of many types of Ankoseal are known and proved. They are serving over wide temperature ranges and in varied electrical applications all over the world.

The laboratory and engineering personnel, the test equipment, the manufacturing resources of The Ansonia Electrical Company stand ready to help solve your special cable requirements.

*Call on us. We'll gladly assist you.*

### *Why* **ANKOSEAL**

*solves cable problems*

Ankoseal, a thermoplastic insulation, can help solve many electrical engineering problems, now and in the future. *Polyvinyl* Ankoseal possesses notable flame-retarding and oil resisting characteristics; is highly resistant to acids, alkalis, sunlight, moisture, and most solvents. Polyethylene Ankoseal is outstanding for its low dielectric loss in high-frequency transmission. Both have many uses, particularly in the radio and audio fields. Ankoseal cables are the result of extensive laboratory research at Ansonia—the same laboratories apply engineering technique in the solution of cable problems of all types.

## **THE ANSONIA ELECTRICAL COMPANY**

*Specializing in "Ankoseal" a Thermoplastic Insulation*

**ANSONIA • CONNECTICUT**



*A Wholly-Owned Subsidiary of*

## **NOMA ELECTRIC CORPORATION**

**GENERAL OFFICES • NEW YORK, N. Y.**

Makers of the famous Noma Lights—the greatest name in decorative lighting. Manufacturers of fixed mica dielectric capacitors and other radio, radar and electronic equipment.

● "The impossible takes a little longer"...this is one way of saying that the draftsman lets no out-worn conceptions restrict his creative ideas. Yet without his specialized technique for expressing ideas on paper, the designs he creates could scarcely be turned into substance. As the draftsman relies on his own hands and eyes, he calls likewise on his drafting instruments to serve him functionally. So integral a part of his technique do they become, they are virtually his partners in creating.

For 78 years Keuffel & Esser Co. drafting equipment and materials have been partners, in this sense, in creating the greatness of America, in making possible our fleets of ships, our skyscrapers, our overwhelming weight of armor on the battlefield...So universally is K & E equipment used, it is self-evident that every engineering project of any magnitude has been completed with the help of K & E. Could you wish any surer guidance than this in the selection of your own "drafting partners"?

Because of their balance, smooth action and responsiveness to your hand, you will find that using MINUSA\* Drawing Instruments is almost as natural as breathing. Their legs are round and tapered, without the harsh feel of sharp corners. Joints are firm, snugly fitted, and satin-smooth in operation. Yet these instruments are strong and durable, for their precision will outlast years of continuous use. For complete data on MINUSA\* Drawing Instruments, write on your letterhead to Keuffel & Esser Co., Hoboken, N. J.

\*REG., U. S. PAT. OFF.

# partners in creating

**K+E**  
*Drafting, Reproduction,  
 Surveying Equipment  
 and Materials.  
 Slide Rules,  
 Measuring Tapes.*

  
 ...the world's  
 mightiest fleet

  
 .. speediest  
 tanks

  
 ...tallest  
 skyscrapers

**KEUFFEL & ESSER CO.**  
EST. 1867  
 NEW YORK • HOBOKEN, N. J.  
 CHICAGO • ST. LOUIS • DETROIT • SAN FRANCISCO  
 LOS ANGELES • MONTREAL

# HOW EXCELLENCE IS



● An inspector examining mica capacitors.

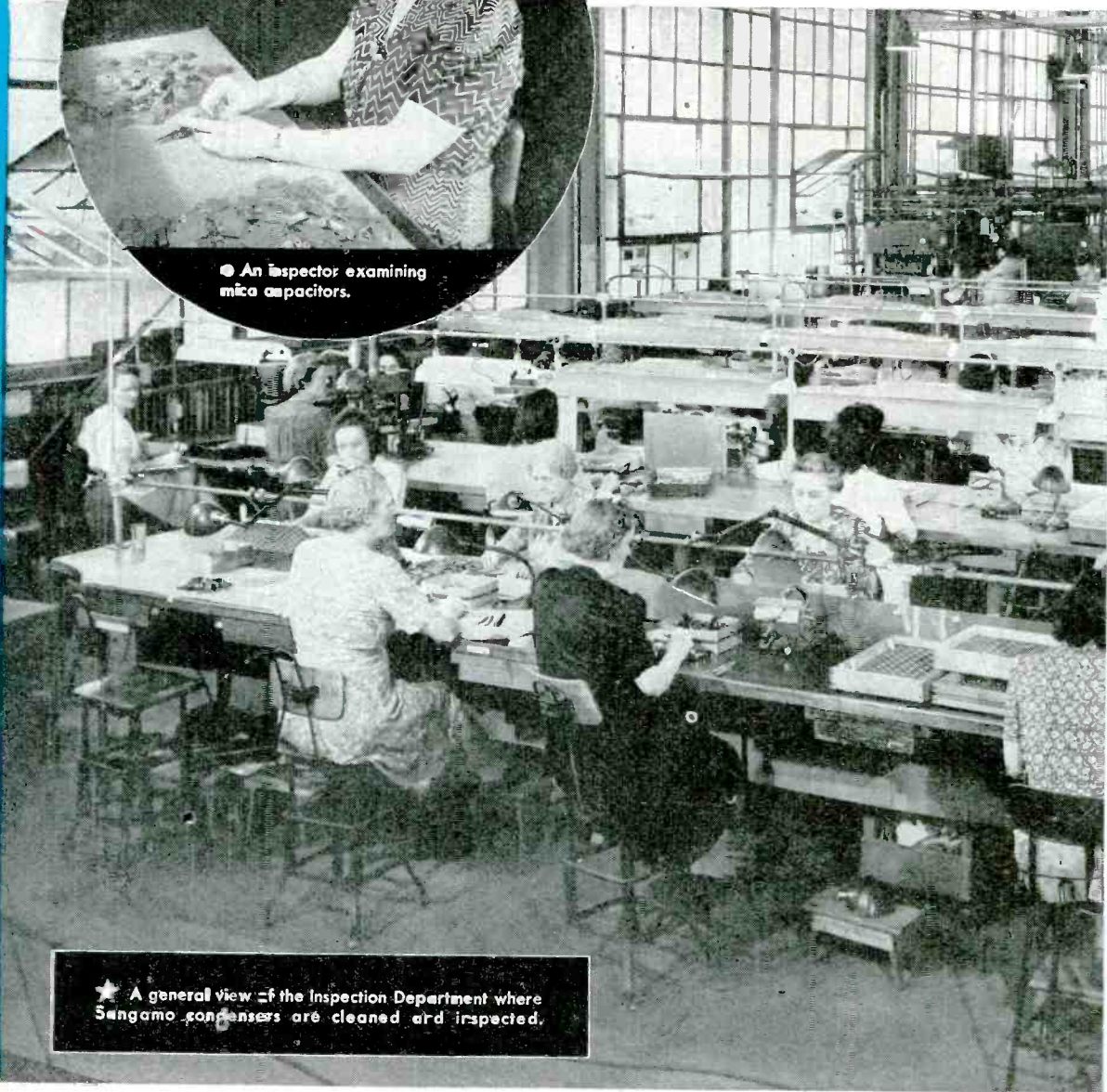
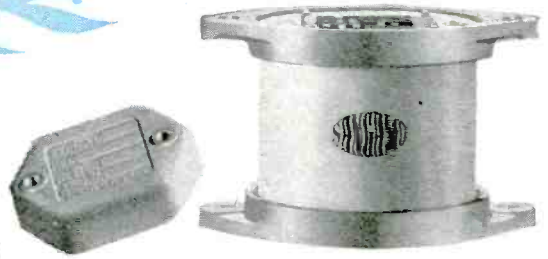

★ A general view of the Inspection Department where Sangamo condensers are cleaned and inspected.

## SANGAMO ELECTRIC

ESTABLISHED 1898 . . . MICA CAPACITORS . . .

**BUILT INTO**

# Sangamo



## MICA CAPACITORS



### *Cleaning AND Inspecting*

The moulding operation encases the capacitor in a moisture-resistant bakelite enclosure. This operation causes the dies with which it is performed to leave a thin flash of bakelite where the dies join. The removal of the bakelite flash is accomplished either by the use of a special finishing die through which the capacitor passes, or by scraping the flash manually with a knife. In some cases, if the flash is thin enough, the capacitor is finished by strapping against a rough meshing. In all instances, the result must be a smooth, finished-looking capacitor.

Another finishing operation is inspection and the cleaning of the terminals, so that proper contact is insured when the capacitor is installed.

Capacitors are also inspected for physical imperfections, such as cracks, chips, and foreign inclusions in the bakelite, as well as for mechanical dimensions. It is essential that each capacitor passed must be within the right physical tolerances in order to insure that it will fit properly in its designated space in the customer's equipment.

Trained operators inspect each Sangamo mica capacitor and thus insure the excellence of quality inherent in these units.



**COMPANY** **SPRINGFIELD  
ILLINOIS**

• • • WATT HOUR METERS • • • TIME SWITCHES • • •



# RAYTHEON

## Type 2B25 - A Miniature High-Voltage High-Vacuum Rectifier

### Electrical Characteristics of Type 2B25

- Filament Voltage (AC or DC) . . . . . 1.4 volts
- Filament Current . . . . . 110 amps.
- Maximum Peak Inverse Voltage . . . . . 2800 volts
- Maximum Peak Plate Current . . . . . 9.0 ma
- Maximum Average Plate Current . . . . . 1.5 ma

TYPE 2B25  
AVERAGE CHARACTERISTICS

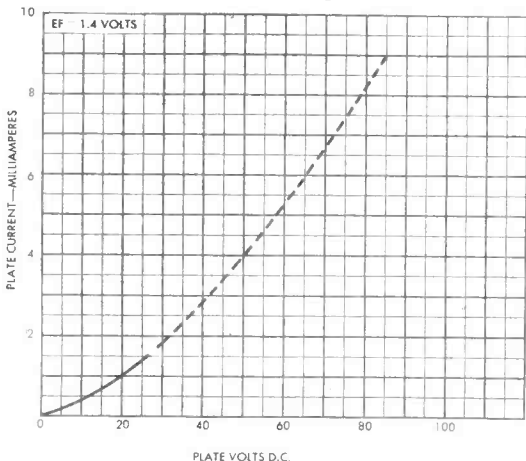

A recent development for the expanding Raytheon miniature tube line is the type 2B25 high-voltage, high-vacuum rectifier. This tube requires approximately 0.15 watts filament power, yet can deliver 1000V DC at 1.5 ma.

These characteristics make it applicable to various forms of electronic equipment in which its small size and rugged construction may be very desirable features. Furthermore, with proper precautions, the low filament power can easily be supplied from an oscillator if it is desired to rectify low radio frequency to obtain direct current power within the 2B25 voltage and current ratings. Plate and filament potentials can be turned on simultaneously without damage and heating is practically instantaneous—thus making this tube suitable for intermittent usage.

Other possible applications include operation as the rectifier in battery vibrator power supplies designed to supply the high voltage DC for small portable cathode ray oscilloscopes or special test equipment.

Raytheon type 2B25 and the many other types in Raytheon's complete line are precision-engineered and quality-built for utmost efficiency and maximum dependability. Look to Raytheon for the *best* in tubes for your postwar products!

All Four Divisions Have  
Have Been Awarded  
Army-Navy "E" With Stars



Radio Receiving Tube Division

Newton, Massachusetts • Los Angeles  
New York • Chicago • Atlanta

DEVOTED TO RESEARCH AND THE MANUFACTURE OF TUBES AND EQUIPMENT FOR THE NEW ERA OF ELECTRONICS

# Does Your Product Require Electrical Wiring?

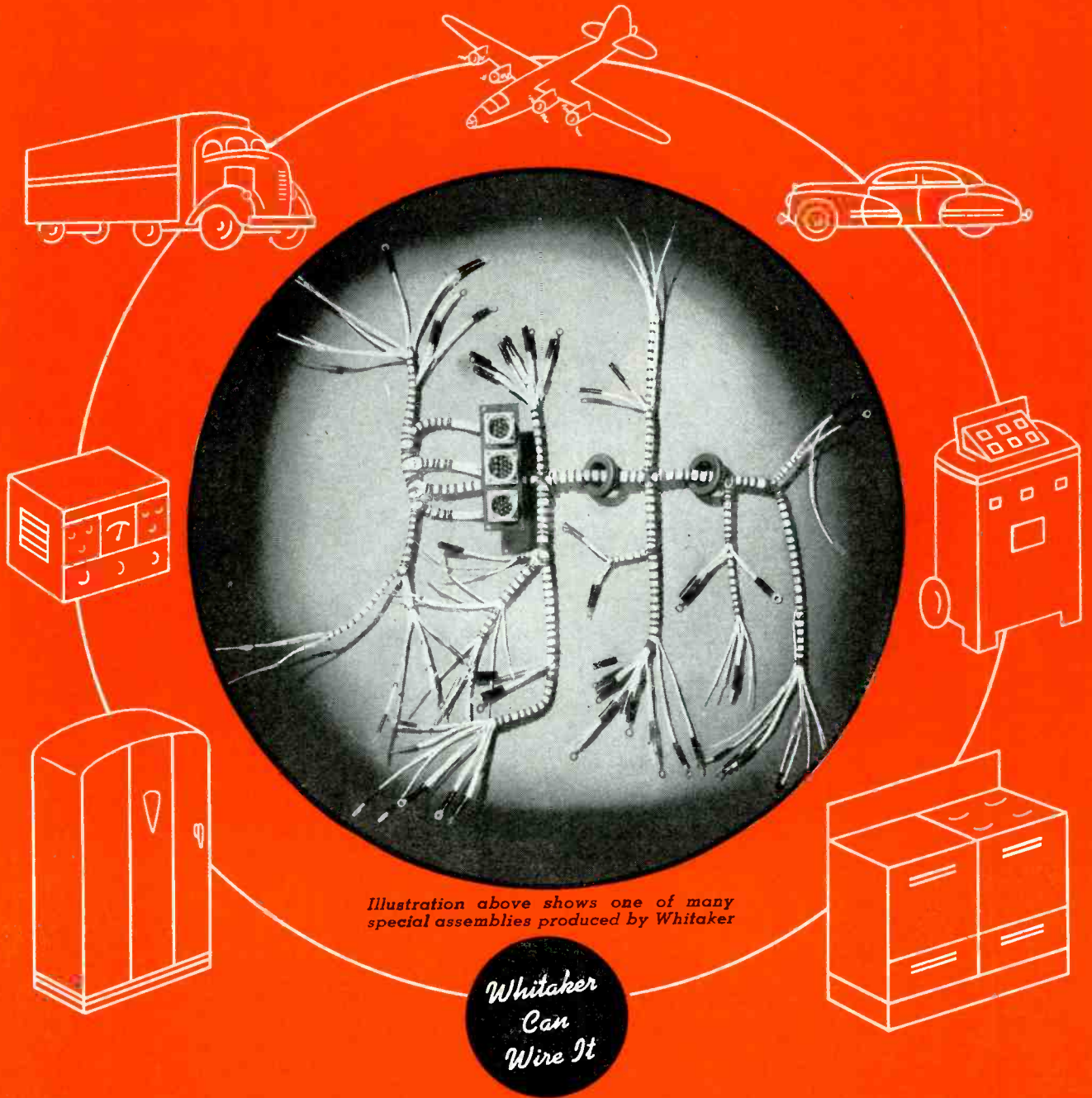

Illustration above shows one of many special assemblies produced by Whitaker

*Whitaker  
Can  
Wire It*

**If your production needs include:**

- ★ **WIRING HARNESES**
- ★ **CABLE ASSEMBLIES**
- ★ **BONDING JUMPERS**
- ★ **CABLE or TERMINALS**

-- we cordially invite you to write and advise us of your needs.

## **WHITAKER CABLE CORPORATION**

General Offices: 1311 Burlington Ave., Kansas City 16, Missouri

Factories: Kansas City, Mo. • St. Joseph, Mo. • Philadelphia • Oakland

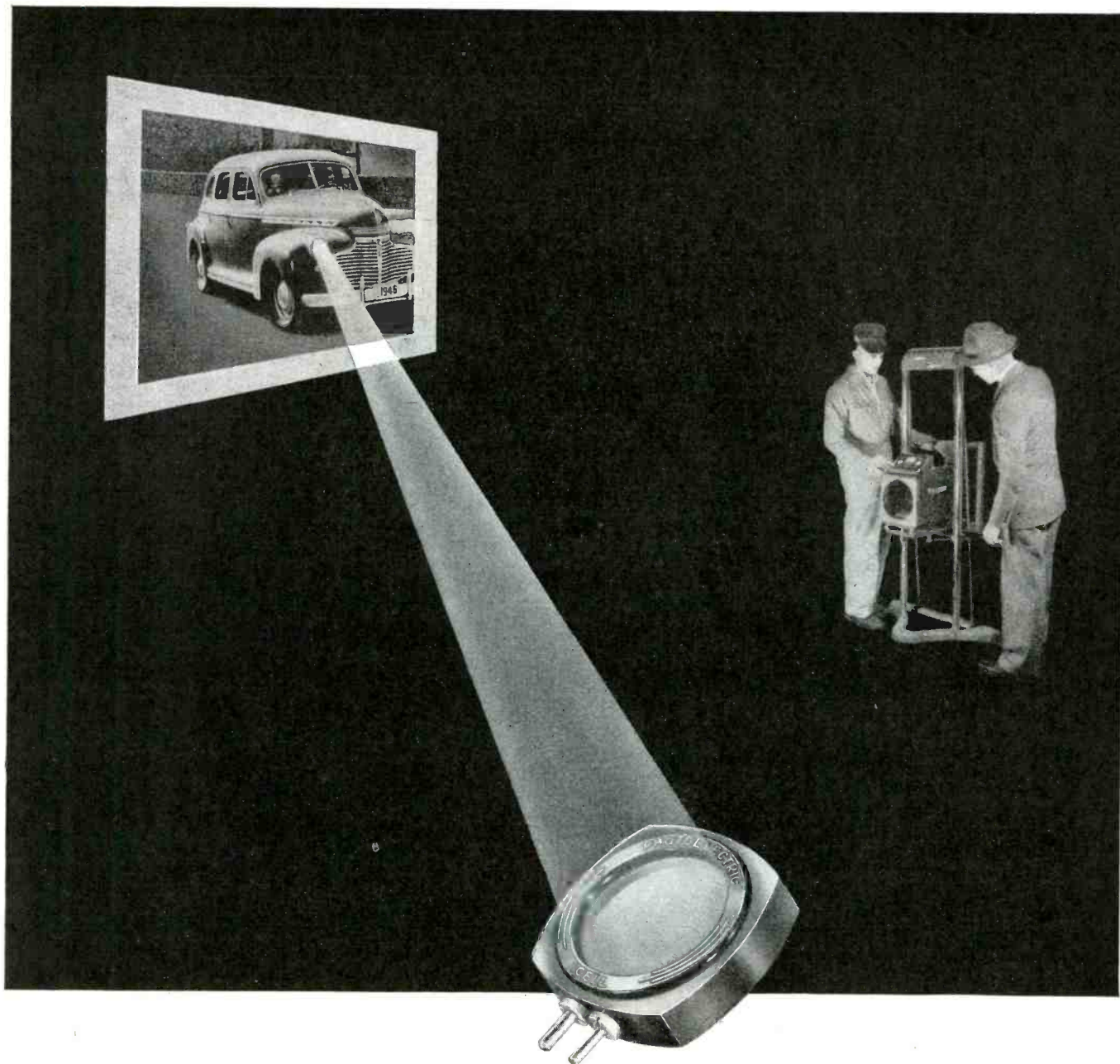

## Watchman telling of the night—by day

The heart of the Rayoscope Headlight Tester, made by Weaver Manufacturing Company of Springfield, Illinois, is a Luxtron\* photocell. Simplicity and stamina make the photocell a heart that will keep on beating in any mechanism that must take rugged treatment.

The "magic" of Luxtron photocell

\* T. M. REG. U. S. PAT. OFF.

conversion of light into electric current is performing many measurement and control operations. What seems like magic to the layman proves a willing tool in the hands of engineers. If you have an idea for putting photocells to work in your equipment, write Bradley for samples and application assistance.

### Write for Rectifier Data

Bradley also has available a complete line of unique copper oxide rectifiers, featuring mounting flexibility, pre-soldered terminals for ease and safety in assembly, low forward resistance with high leakage resistance, and gold coating of pellets to provide long life.

Data on five basic models are included in an illustrated Bradley "Coprox" Rectifier bulletin sent on request. Please write for it.

**PHOTOCELLS—MASTERS OF LIGHT**

# BRADLEY

**MASTER OF PHOTOCELLS**

**BRADLEY LABORATORIES, INC., 82 MEADOW STREET, NEW HAVEN 10, CONNECTICUT**



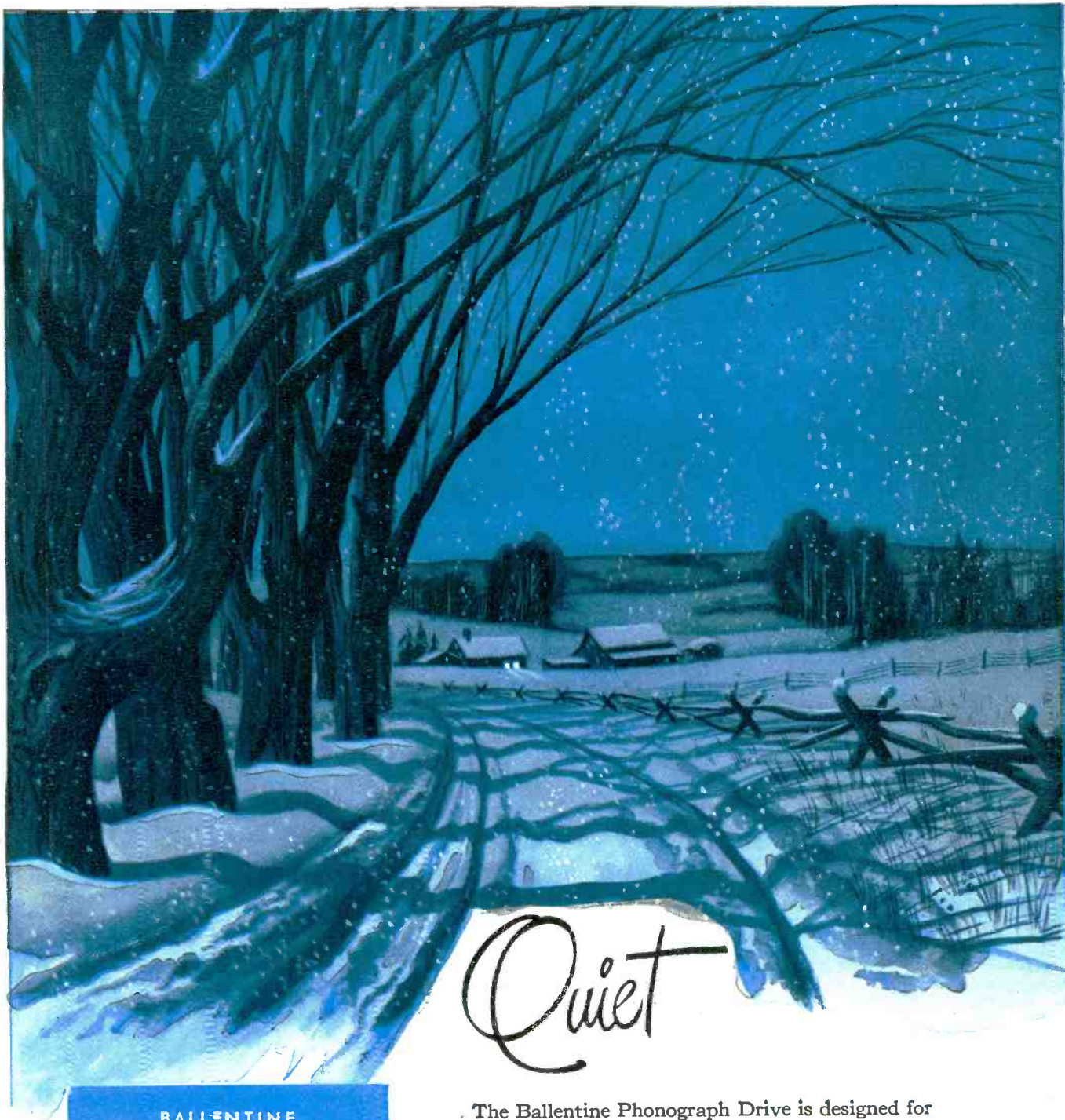

Quiet



The Ballentine Phonograph Drive is designed for just one purpose—to provide a reliable mechanism with the least possible background noise or rumble.

The high degree of perfection achieved by the Ballentine Phonograph Drive is the result of *precision dynamic balance*, excellence of design, rigid adherence to close tolerances plus modern manufacturing methods and equipment.

Send today for descriptive folder on the Quiet BALLENTINE Phonograph Drive.

# RUSSELL ELECTRIC COMPANY

366 W. HURON STREET, CHICAGO 10, ILL.

# Manufacturers of BALLENTINE PHONOGRAPH DRIVE



# WHY CHOOSE UTC?

## FOR WAR AND POSTWAR COMPONENTS

1. **UTC IS THE LARGEST** TRANSFORMER SUPPLIER TO THE COMMUNICATIONS INDUSTRY.
2. **THE SCOPE OF UTC PRODUCTS** IS THE WIDEST IN THE INDUSTRY.
3. **UTC ENGINEERING LEADERSHIP** IN THE INDUSTRY IS ACCEPTED . . . WE DESIGN TO YOUR NEEDS.
4. **THE QUALITY OF UTC PRODUCTS** IS HIGHER THAN EVER.
5. **THE DEPENDABILITY OF UTC PRODUCTS** IS BACKED BY MANY YEARS OF EXPERIENCE. UTC IS NOT A WAR BABY.
6. **UNEXCELLED PRODUCTION FACILITIES** MAKE UTC'S PRICES RIGHT AND DELIVERIES ON TIME.



*United Transformer Corp.*  
150 VARICK STREET  
EXPORT DIVISION: 13 EAST 40th STREET,  
NEW YORK 13, N. Y.  
NEW YORK 16, N. Y., CABLES: "ARLAB"



ALL PLANTS



# ELECTRONIC INDUSTRIES

Including INDUSTRIAL ELECTRONICS

O. H. CALDWELL, EDITOR ★ M. CLEMENTS, PUBLISHER ★ 480 LEXINGTON AVE., NEW YORK (17), N. Y.

## ***In the Wake of the Atomic Bomb***

Atomic energy has long been demonstrable as a feeble effect in the laboratory, and long recognized as the source of the sun's tremendous power. And now through man-made electronic mechanisms, war has produced atomic energy on a scale measured in trillions of kilowatt-hours.

Such concentrations of energy eventually must work great changes in all industry. In our field it may mean unthinkably-light power sources, replacing our present massive chemical batteries. Tubes may even be self-excited. With unlimited energy, new light apparatus designs may appear.

The electronic sciences created atomic power; atomic power may some day remake the whole electronic art.

## ***Brain and Nerve Study***

Research that promises to be outstanding among electronic projects and with most far-reaching results on human progress, concerns the study of nerve and mental processes and the mechanism of the biological processes of living cells of all types. In a number of institutes electronic processes are already used to the limit. But so many interesting effects have been found that it has been impossible for the neuro-psychiatric experts to keep up with the interpretation and correlation of these tests to known mental difficulties. When one remembers that no small part of a taxpayer's dollar goes toward the care of mental unfortunates, it is evident that here is one project that cannot help but pay back big dividends by reducing future costs in treating mental cases, and in helping eliminate their causes.

## ***Analyzing the Analyzer***

One of the most needed developments in carrying out the aforementioned research is some sort of analyzer or electro-encephalograms. These are records made for the brain-wave currents, and as many as six or more continuous records may be taken at the same time. The record appears as parallel wavy lines on a chart, the curves being a summation of a great many frequencies which "come and go" at random intervals. These frequencies are in the range of between a few cycles and about fifty cycles. While visual analysis of these curves discloses much information, it is possible that less than 10 per cent of the information appearing therein is actually found during their analysis with present methods. An "electronic" analyzer of some sort should show the complete story—providing also a good problem for postwar research.

## ***Well Done, Dr. Baker!***

Two big jobs for radio have just been completed under the direction of Dr. W. R. G. Baker: (1) The formulation of sound radio-engineering principles by the Radio Technical Planning Board, and (2) the raising of over half-a-million dollars for the IRE Building Fund. Meanwhile Dr. Baker, as GE vice-president, has supervised one of the vastest electronic production programs in American industrial history—an outstanding example of the results achievable "when engineer is boss"!

Such executive talents are needed in top places in engineers' organizations, and certainly Dr. Baker may expect to be drafted for other important top industry posts.

## **ATOMIC BOMB, RADAR, SONAR—ALL THANKS TO ELECTRONIC ARTS**

The world generally recognizes what the electronic industries have done in creating radar, sonar, walkie-talkies, battlefield FM and other military communications—as well as producing them in adequate and overwhelming quantities.

But in the sudden unveiling of the atomic bomb, little has been told about how the electronic mass-spectrometer laid the foundations for atomic-energy research, how the electronic cyclotron carried on the first atom-splitting experiments, and how electronic devices and electronic methods have surrounded the production of the atomic bomb, even up to the instant of releasing it upon the enemy. It's all electronic!

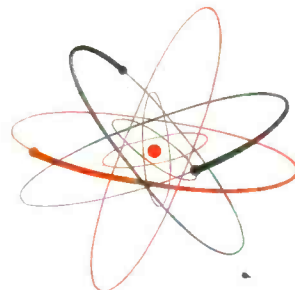

U-235

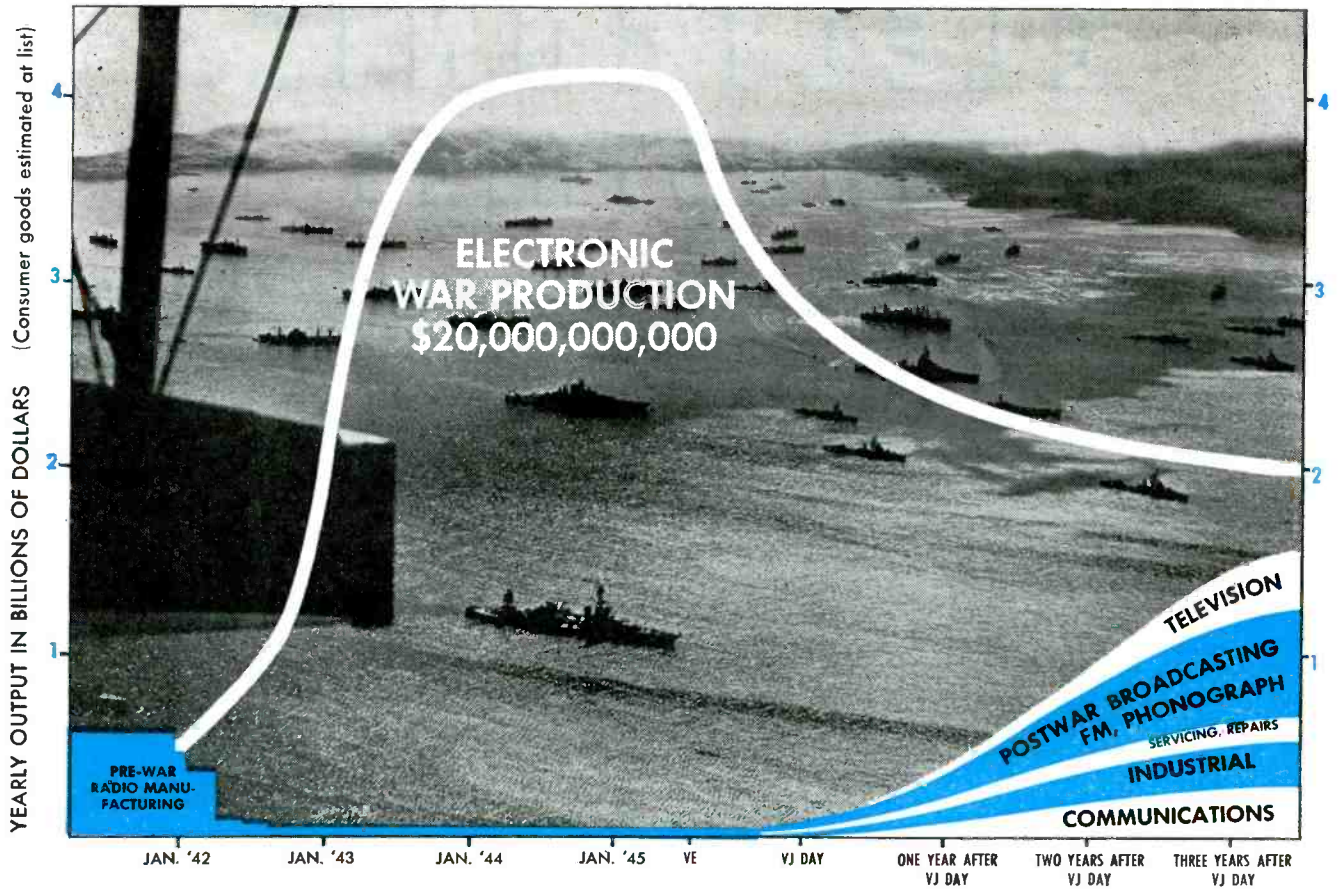

War-swollen to production efforts exceeding twenty billions of dollars, American factories will soon turn to postwar reconversion and a rising curve of output paced to supply a tremendous dammed up demand for home receivers, communication equipment and industrial electronic apparatus

# POSTWAR ENGINEERING

***How technological advances born of war efforts are likely to affect communications and industrial electronic design***

• Already many electronic engineering organizations are turning attention to designs and operations for postwar. With military cutbacks in sight before long, both management and engineering groups are looking to products and plans for the time after V-J Day.

For four years all effort has been directed at war. This has been a period of tremendous technological advances, under the impact of over 20 billion dollars spent for military radio and radar. Now the planners and designers must pick up all the slack that has developed since they left off before Pearl Harbor. A tremendous amount of design and production will be needed to catch up.

In the radio-receiver field, for example, some 50 million sets remain "unborn" based on 1941's out-

put of 13 million radios. Industry leaders estimate a conservative immediate backlog of demand amounting to 20 million sets in the first full year. New developments like FM will obsolete great numbers of existing receivers. And new directions of design, like the "vest-pocket radio," will start a rush by many makers to meet new public needs.

In the peacetime transmitter field, aside from the more familiar AM expansion to higher station powers, 420 applications for FM licenses are now before the FCC. These FM station applications are in addition to the 53 FM stations now authorized, only about half of which are yet constructed; and 120 television-station licenses are now applied for, in addition to the nine or ten television transmitters which

are now authorized or operating.

All of these things involve engineering, production and technical problems, to a considerable extent already solved as a result of the tremendously accelerated research programs that have been vital to war developments, and all of them point to postwar progress and many new things to come. These things are on the drafting boards now, and in the laboratories, and, in many cases, actually getting started in production.

"Citizen's Radio," for example, is one of these developments for which the industry sees great promise and that has become an engineering possibility as a result of research into the use and behavior of the ultra high frequencies. Unquestionably, there has been a lot

of bally-hoo over probable uses of Handi-Talkies with which the farmer's wife will call the hands to dinner and that may serve for a late husband to call the little woman to keep the roast hot. But just as unquestionably there will be wide use for such equipment in various industries, in the professions, for civic use, and, to a lesser extent by amateurs.

### Mobile public radio

Radio telephone service to and from automobiles is very definitely on the cards with plans already completed by AT&T for its inauguration as soon as materials and manpower may be available. Presumably, many of the engineering problems incident to such a program have been licked; production of necessary equipment may be very considerable. And then there are the railroads which for years have carried on extensive experimenting looking to far-reaching use of various forms of induction and space radio as a means of easing and speeding and making safer railroad travel and the movement of goods.

These things represent some of the many new uses to which spots in the radio spectrum will be put. Television, obviously, is in for a tremendous future, probably will expand along many new lines such as its proposed use in department stores, for example, where centralized displays and advertising announcements can be viewed simultaneously all over a great merchandising institution; hotels without television screens in each room may soon be as obsolete as are today's hotels without radios or loud speakers in each room connected to centralized receiving equipment.

How far various forms of electronic dielectric and induction heating may go in the near future is almost anyone's guess. Daily, new uses are found for equipment that only a short time ago was little more than a laboratory curiosity. New tubes, components, and above all, new knowledge are rapidly extending the field of applications where such equipment does the job quicker, better, more efficiently than it can be done by any other means.

Most engineers and many others have stated that products, such as radios and similar equipment, will not be greatly changed in the immediate postwar period though this is not altogether true. The fact must be realized that it is true that new circuit developments will no be too prominent, certainly in home receivers and in medium-to-high frequency transmitters.

However, the war period has pro-

duced many improvements, in components particularly, which in themselves make the products something new. But these things do not show from the outside and thus the story gains acceptance that most of the products will be revised versions of prewar models.

Tubes, for example, have been greatly reduced in price and improved in quality. The miniature glass tubes which were just being introduced in battery operated personal size radios before the war are now available in a variety of standard 6.3 volt ac operated types for consideration in designing complete radio and television receivers.

These new glass miniature tubes which have received wide application in military equipment are both compact and efficient, at low, me-

ized mass production methods are now being seen in the various demonstration models of television equipment as well in cathode ray apparatus being built and used currently. Improved electron gun designs and greater uniformity have produced tubes which have a smaller spot size for better definition in complex patterns. The use of post-deflection acceleration anodes has been developed to the point where extremely fast scanning rates are available from cathode ray equipment. Improved phosphor treatments have given greater brilliance to fluorescence. Flat face cathode ray tubes for projection television and other purposes seem to be the probable type for direct viewing systems.

### War born advances

The greatest improvement in capacitors, resistors and transformers during the war period has been along the lines of tropicalization or treatment to prevent damage from moisture, fungus growth, etc. While it is doubted whether many of these developments will find widespread use in radio equipment for use in the continental United States, certainly the technic of safeguarding these components has been learned and apparatus exported to Central and South America undoubtedly will use this treatment. Special glass-to-metal seals have been developed for all of these components, where they are placed in metal cans and evacuated. These are common items today and undoubtedly their cost, as well as the cost of the hermetical sealing will be reduced to a point where it is practical to use them in all commercial equipment at least.

The expanded facilities of electrical grade plastic insulation will undoubtedly show itself in better electrical insulation in receivers and transmitters. The polystyrene types of plastics, as well as many others, are being made in very large quantities and may therefore offer serious competition to cheaper forms of insulation. Likewise, the ceramic industries have expanded their facilities and learned a great deal during the war about producing new and special types of material. This is also true of the glass-bonded mica and other insulation fields. These better insulation materials will mean better stability in radio receiving equipment, something that is required at television and FM frequencies.

Wire-wound resistors of the power type as well as the precision instrument type are being made with greatly expanded facilities. The product is better than prewar,

## ATOM SPLITTING

**Mothered by research that gave birth to the cyclotron, first effective atom splitter, release of the tremendous energy until now securely locked in the atom unquestionably presages great scientific advances. As indicating the power possibilities of the new technics that have made the devastating atom bomb possible, Professor Einstein, father of the relativity theory, has pointed out that energy available in a given mass is proportional to the mass multiplied by the square of the velocity of light. That practical means of harnessing this vast store of potential power eventually will be developed by the physicists and scientists who have succeeded in releasing small parts of it for war uses there can be no question. Equally unquestioned must be the reflection that much time will be required for the job.**

—Editors

dium and up into the ultra-high-frequency ranges. They are available in electrode combinations which in general duplicate the more popular types of radio receiving tubes used in prewar sets.

Even smaller battery operated types will be available and are now being used. These new miniature tubes will find wide application in personal type radios, hearing aids, civilian walkie-talkies, etc. An extremely small thyratron is also being made in this very small tube size.

Cathode ray tube developments during the war period have been very great, and results of standard-

and will be cheaper. Better types of coating material for power resistors have been developed and their application improved to a point where certain resistor types will withstand extreme punishment.

In the merchandising of parts, for instance, some of the more expensive lines that have been sold in large quantities to the armed services will be supplanted in volume sales by items designed for the less rugged requirements of a civilian economy. Some things such as rheostats, however, which have given much trouble in the past can be expected to be better performers due to more solid construction and better manufacturing control.

Many new types of wire insulation have been developed, such as fibre glass, silicones, various synthetics, asbestos compound, etc., some of which lend themselves to better manufacturing technics.

Certainly there will be an improvement in the interior appearance of sets, not only those offered to the public but in apparatus for industrial use only.

Following wartime practice, cabling of leads to as great an extent as possible may replace the old hit or miss wiring.

The outstanding advance towards smaller sizes in transformers of all kinds for radio use will be one feature facilitating the development of smaller sized sets.

Whether cabinets are made of plastics, wood or some molded wooden composition will undoubtedly be up to the individual manufacturer. However, greater use of colorful design and good designs in general should be noticed.

It is quite possible that in advertisements more information will be available on the actual performance, not only of parts but of sets on an overall basis as manufacturers who really have something to sell in this respect make full use of their advantage.

As television comes to be more important, antenna design and installation will be an increasing factor in the industry and highly efficient sections made very light in weight, either of metal or wood, will undoubtedly find a ready market.

Quality of tubes, already fairly high before the war, will undoubtedly be improved as the manufacturers find monetary return from closer quality control. Inductance coils incorporated in sets will, like transformers, tend to become smaller as the air inductor of former days is replaced by the powdered iron cored coil. There may be a great advance in the use of permeability tuning. Condensers will undoubtedly feature more rugged design and better structure.

#### **Replaceable units**

An interesting practice has arisen in connection with certain industrial sets. This is manufacturing with replaceable circuit elements of a plug-in type so that if anything goes wrong a new circuit element consisting possibly of resistors, capacitors and inter-stage coupling coils can be plugged in as a replacement unit.

Much work has been done in the past few years in linearity in amplifier design and it is to be expected that audio amplifiers will feature linear reproduction characteristics. In the rf band, circuit quality will be particularly needed in FM sets where frequency selectivity in coupling networks must be guarded against.

The enormous application of relay and small control type motors to military apparatus will undoubtedly have its effect on radio. Undoubtedly a greater use of relays for switching and motors for special remote control problems will find application.

The great progress in ultra-high-frequency equipment and technic will most likely make itself felt in peacetime markets in large complete communication systems such as television relay, civilian walkie-talkie telephone service, railroad communications and similar complete systems. The tubes which have been developed for these high frequency applications will provide better television service and better FM service in the postwar transmitters. Developments of wave guides, horns and other microwave apparatus, though, probably will not find their way into the average radio owner's home, at least for many years to come.

Much design power has been put upon test equipment during the war and the many kinds of electronic meters with extended ranges which have been developed should find applications in other industries as well as in the radio field. Steel cases and attractively colored knobs and dials increase the eye appeal of this equipment. Development work on oscillographs has tended towards greater stability mechanically as well as electrically. Linear amplifiers capable of accepting steep wave fronts have become a necessity, and properly calibrated sweeps have had eager acceptance. The servo-sweep scope has been extensively produced. Tube testers have become more efficient and mutual conductance testing is of ever greater importance.

An interesting development is that of hermetically sealed meters of particularly rugged construction. Many of the smaller sizes are even supplied with magnetic shields to prevent annoying errors from proximity of metallic or current carrying parts, a refinement previously reserved for more expensive models. Altogether the trend is towards better quality, more rugged design, more durability—better performance all around.

## **NAVY'S FLOATING ELECTRONIC LABORATORY**



Shrouded in a deep pall of secrecy, the Navy's second electronic ship, "USS Indian Island," has been put in commission. She is a converted Liberty ship, and while the assortment of radar, radio and electronic equipment in her unquestionably is considerable, details of her contents and activities are a military secret. It is understood that she will be used as a supply ship and for maintenance work required by the Navy afloat and ashore.

USS Indian Island, converted Liberty ship, is the second floating laboratory, supply and maintenance ship to be put in commission

# Atomic Fission Will Have Profound Effect

● The implication of the success of the atomic bomb is so far reaching as to stagger the imagination. The release of atomic energy is unquestionably the most revolutionary discovery in the world economy since the invention of the steam engine that accelerated the industrial revolution in the early 1800's. The cyclotron that initially made possible the fission of the atom was itself an electronic product. The electronic industries in turn inevitably will feel the repercussion of the atomic energy it has released.

Many complicated controls must yet be devised before atomic energy can be applied safely to industry. However, once having learned the war time secret of controlling the chain reaction necessary for a blitz bomb, the time may not be far off when the transmission of power by radio may be released from the energy locked within the atom. It may be even more efficient for each household to have its own generating unit than to transmit electricity from central stations at remote distances.

Design for atomic energy generators employing the principle of the flash boiler already can be conjectured. How inexpensively electric power could be manufactured and distributed under such conditions one would not dare state but it is safe to assume it would ultimately make electricity available for heating and for a legion of other purposes not yet economically feasible. Synthetic metals may be produced

By DR. HARLAN T. STETSON

Dept. of Terrestrial Magnetism  
Massachusetts Institute of Technology, Cambridge, Mass.

## *Transmutation of elements and cheap power generation may revolutionize electronic world—ionization effect*

through transmutation of elements that will make possible new and more efficient broadcast tubes and radio and the cost of electrical equipment may be materially reduced when the secrets of inexpensive atomic power have been controlled and released.

No one yet knows how much or for how long the ionization of the air over atomic bomb areas will ef-

fect the dielectric constant and materially changed atmospheric condition for the propagation of radio waves.

As every new invention has both constructive and destructive possibilities probably rigid regulations will have to be formulated for the control and application of atomic power once it is in the hands of the public.

It is interesting to reflect that atomic physics which has brought about the splitting of the atom in the laboratory received much of its stimulus from the astrophysicists whose curiosity on the ultimate nature of matter was stimulated by the search for the secret atomic processes taking place in the sun and the stars whose source of radiation has only recently been traced to the transmutation of elements in the cosmic crucibles of remote space.

We have again had a dramatic example of the relatively short elapsed time between the results in a field of pure science and the application of results to engineering accomplishments of far reaching concern to man.



Dr. Harlan T. Stetson, authority on cosmic ray phenomena, at work in MIT laboratories

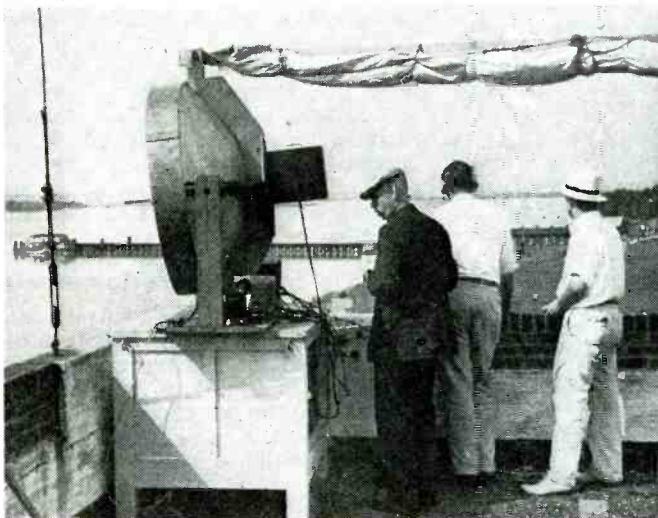

Dr. A. Hoyt Taylor (left), with two associates, Dr. Claude Cleeton and John P. Hagen, on the roof of the Naval Research Laboratory in 1937, test first shipboard radar, later placed in operation on the USS Leahy

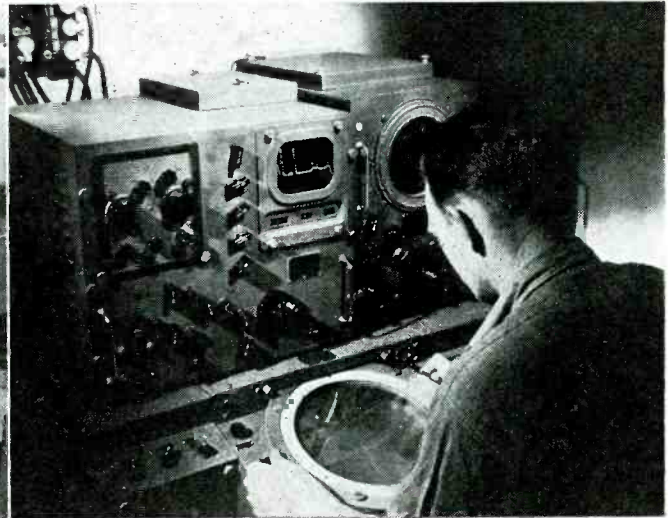

Determining distance and bearing of a target at Naval Air Station, Anacostia, by radar. Tube showing a graph line is an A-scope. The larger disc into which the operator is looking is Planned Position Indicator

# SYNCHRO CONTROLS for

By **RAYMOND GOERTZ**

Project Engineer, Sperry Gyroscope Co., Inc., Garden City, N. Y.

**Angular rotation and the sum and difference of two or more angles can be used to control distant operations**

● Synchro data systems date back to about 1901, but it is only recently that they have received the attention they merit. The useful characteristics of these systems, long recognized and utilized by the designers of control mechanisms for the armed forces, is finding for them an even wider field of application in industrial controls.

Briefly, synchro data systems are used to transmit accurately angular shaft position information from one point to another over electrical wires. In recent years marked strides have been made in their

application to automatic controls and servo mechanisms.

The word "synchro" is the term presently used by the Navy as a class designation for the electrical devices hereafter described, regardless of their manufacture. It will be used here in its broad sense to include similar products of whatever manufacture.\*

The synchro-generator (also called a transmitter) is an electromagnetic device, the shaft of which is to be driven by some prime mover. The rotor is excited with single phase ac and the stator de-

livers electrical ac voltages, varying in magnitude and phase, which represent the angular position of the rotor. This instrument converts angular positional information into electrical information that may be interpreted at a remote point by some receiving device.

### Synchro motor

A synchro motor, also known as repeater or receiver, is a device similar to the generator except its shaft is free to turn and assume the angular position corresponding to the electrical information coming to it.

The synchro control transformer receives electrical information of angle and converts it into a single ac signal which varies in magnitude and phase according to the displacement of its rotor with respect to the electrical order that it receives. A synchro differential generator is a device which can be inserted in the electrical circuit running from a transmitter (synchro generator) to some receiver device and modify the angle by an amount equal to rotation of its own shaft. It may thus add or subtract from the angle in the system.

The synchro differential motor is a unit, the shaft of which is free to rotate and take up the difference between the angles of two synchro generators, both synchro generators, having their shafts driven. The synchro capacitor consists of three equal capacitors connected in delta. This device is used to improve the power factor of the synchro system.

### Operation details

The basic principle of a synchro generator is shown in Fig. 1 (indicated here as a ring winding to simplify its functions by eliminating the confusing wires in the regular system). The stator of the common synchro unit consists of a

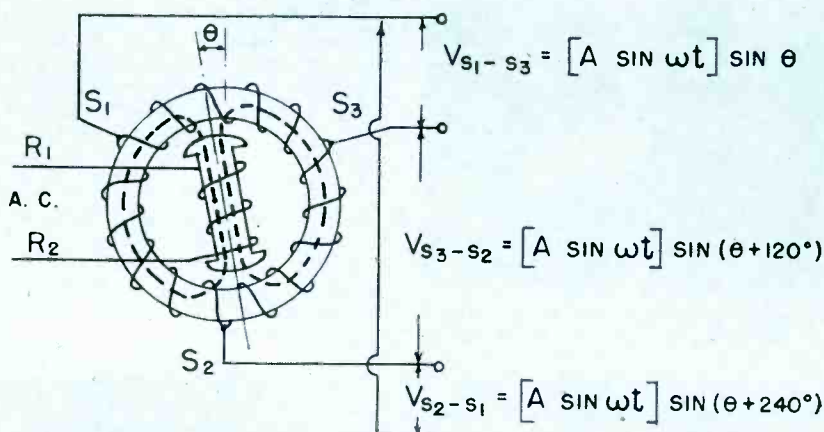
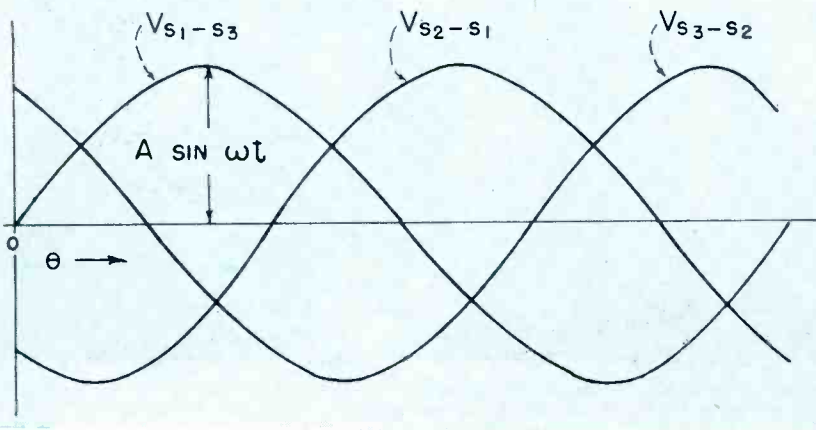

Fig. 1—Armature excited with ac induces voltages varying with position angle

Fig. 2—Shown below: Terminal voltages vary with time as well as position of armature



\*For example, a widely known term for this type of unit is the word selsyn, a General Electric trade name for their products of this design. We also find autosyn (Bendix), telegon (Kollsman), synchro (Ford Instrument), Diehlsen (Diehl Mfg. Co.), etc., are other names used at various times and places.



# METERS AND SERVOS

punched lamination assembly wound with what might be termed an ordinary three phase winding, generally connected as a Y. Actually the winding is not three phase but is merely one that is spaced 120 degrees mechanically.

The rotor of nearly all synchro generators is of the salient pole type, that is, the "dumbbell" type, laminated and containing a single coil. The rotor is excited with single phase ac and by magnetic induction acts as a transformer to induce voltages in the stator winding. The voltages are, of course, a function of the flux linkage between the rotor and the particular coil in the stator.

## Electrical zero

If the salient pole rotor in Fig. 1 were exactly perpendicular instead of positioned slightly counter clockwise, it would be in what is known as electrical zero position. Magnetic flux, excited by the current in the rotor winding, passes out through the ring, divides and comes back from the other side. It can be seen that if  $\theta$  were zero, the voltage between  $s_1$  and  $s_3$  would be zero because the linkages are equal and opposing.

Equation  $[A \sin wt] \sin \theta$  is zero when  $\theta$  is zero. The part of the voltage as indicated by  $[A \sin wt]$  is a constant, which depends upon the number of turns between  $s_1$  and  $s_3$ , the number of turns on the rotor and the rotor excitation voltages,  $wt$  being the angular frequency of the excitation of the rotor. The part,  $\sin \theta$ , is an angular position which varies the ac voltage that is generated in the stator winding and as  $\theta$  is increased, i.e., as the rotor is turned counter clockwise it reaches a maximum at  $\theta = 90$  deg.

## Position angle

The other voltages  $S_3S_2$  and  $S_2S_1$  are equal to  $[A \sin wt] \sin (\theta + 120)$  and to  $[A \sin wt] (\theta + 240)$ . Now naturally as  $\theta$  increases, the sine of the angle will eventually go negative, indicating that the phase of the voltage has reversed. If the rotor were turned exactly 180 deg., then the voltages would be the same as far as magnitude is concerned, but the phase would be reversed.

Therefore, the synchro generator generates electrical information that corresponds to only one position of the rotor. The secondary voltages, shown in Fig. 2, appear to

be the same as we have seen many times in three phase ac machinery, although here they do not mean the same thing. They are not instantaneous voltages at all, but are magnitudes of the ac between the

particular connections, i.e., the  $S_1S_2S_3$  connections on the stator.

The part of the curve shown above the line may be taken to indicate zero phase with respect to the rotor. The part below the line

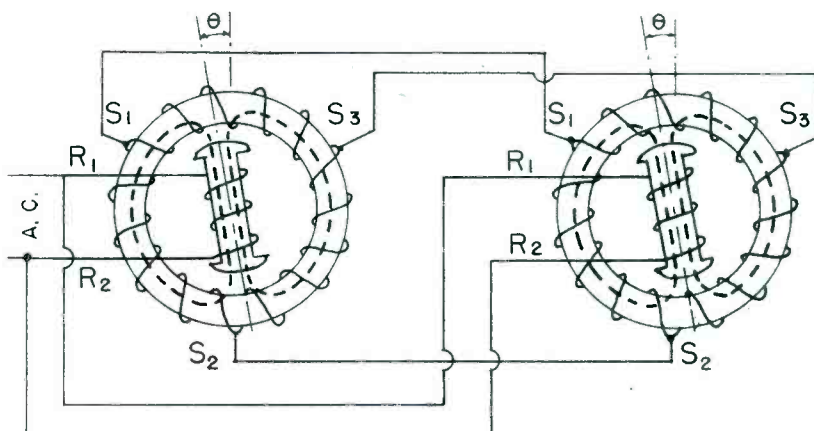

Fig. 3—Synchro motor excited like generator assumes an exactly similar position

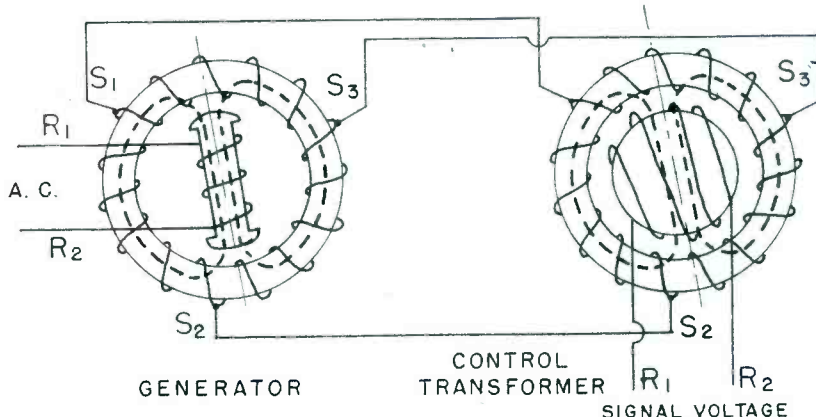
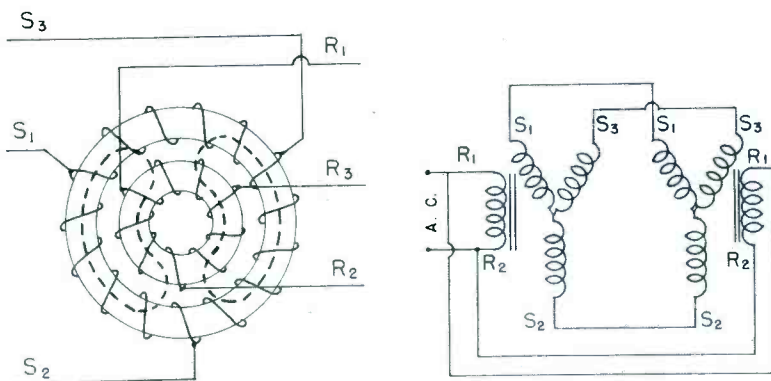

Fig. 4—Control transformers deliver a signal voltage based on armature position



Figs. 5, 6—Synchro differential generator and generator-motor wiring diagram

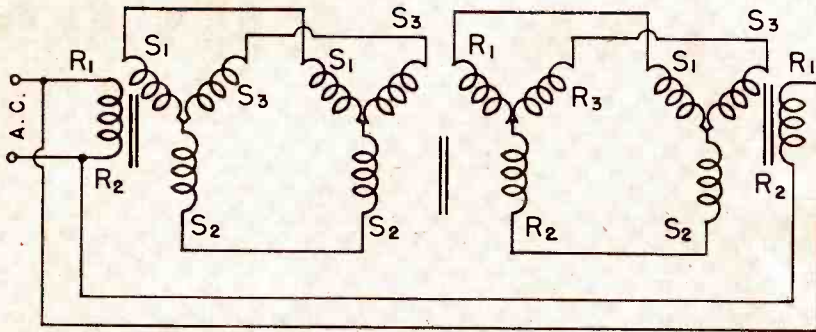

Fig. 7—Schematic of generator connected to motor through differential generator

indicates 180 deg. from that, but is still an ac voltage. These voltages may be considered not time voltages but space voltages, i.e., they are determined from the value of  $\theta$ . If the shaft is held in any position then these particular curves can be "frozen" at any value of  $\theta$ . These voltages transmit information of the position of the generator rotor, whether the rotor is turning or whether it is stopped.

The synchro motor (often called a repeater or receiver) is almost identical physically and electrical-

cept for the addition of an oscillation damper, called a Lancaster damper. The motor, receiving information from a generator, drives its own shaft to correspond to the angular position of that generator. Since the motor is identical, except for the Lancaster damper, it could also be used as synchro generator if desired.

In the actual circuit and use, the synchro motor has its rotor leads connected to the same ac single phase supply as the rotor leads on the synchro generator as in Fig. 3. Now, if the two rotors are at the

same angular position with respect to their stators, then the voltages generated in the stator of the motor and generator will be identical, and if connections are made between each of the leads of the generator and the correspondingly designated leads of the motor, there will be no current flowing because each of the units is generating the same potentials at corresponding points.

### Basic principle

Referring to Fig. 3, there will be a flux set up through the rotor of the motor resulting from the voltages  $s.s.s.s$  because the voltages between  $S_1S_2S_3$  are the same as at the generator. Now, since the motor rotor is excited with the same ac as the generator, if its magnetic flux does not align with the magnetic flux set up by the generator in the stator of the motor, there will be magnetic pull between these two fluxes, causing the motor to try to come into alignment with the flux set up by the synchro generator. This will naturally cause secondary currents to flow in both the stator windings and rotor windings of both the generator and the motor.

The developed torque of a motor, as the angle of the rotor of the motor is displaced from the angle of the generator is generally of a sine wave nature. That is, the torque is proportional to the sine of the angle of the displacement between the motor and the generator. As an illustration of the forces obtained with such a system it may be noted that a size 1F motor operating with a 1G generator develops a maximum torque of 6 oz. in. at 90 deg. displacement between them. It has a torque gradient of .06 oz. in. per degree of error. This is a low torque but is sufficient to turn a small dial and also to turn small actuating devices, such as contacts for operating electrical devices or to operate hydraulic valves. The size 5 units, about three and one-half inches in diameter and five inches long, will develop a maximum torque of about 48 oz. in., with a torque gradient of 4 oz. in. per degree error.

### Accuracy

A size 1 generator operating with a size 1 motor has an average accuracy of about  $\frac{1}{2}$  deg. and has a maximum error of about  $1\frac{1}{2}$  deg. The larger size 5 unit is more accurate, having an average static accuracy of about .2 deg. and a maximum static error .6 deg.

One generator can actually handle more than one motor and if the size of the generator is quite large it can handle a fairly large number of motors.

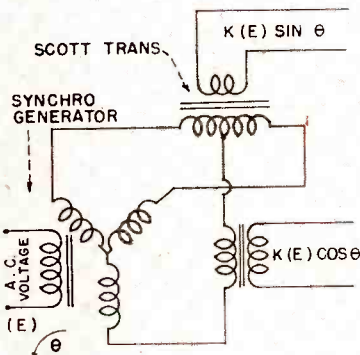

Fig. 8—A 3 to 2 phase Scott connection produces sine and cosine voltages at output

Fig. 9—By energizing the ring stator with 3 phase current and taking single phase off the rotor, phase can be advanced by turning rotor

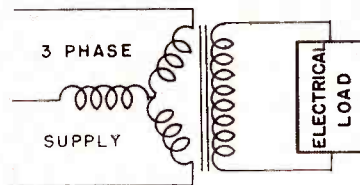
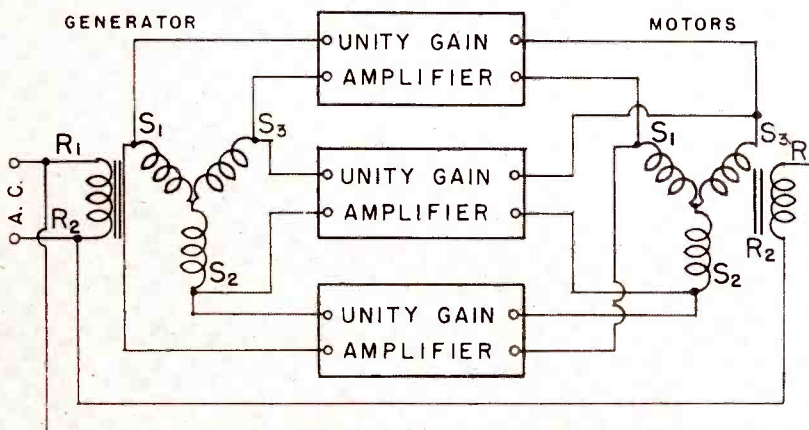

Fig. 10—Electronic amplifiers used to increase power permit use of many motors



If the motor is required to overcome torque, due either to bearing friction or to a load on its shaft, the same torque will be reflected back to the generator. There is no work done by the electrical supply system. The energy must come from the prime mover that moves or drives the rotor of the synchro generator and must do all the work to overcome friction of both units as well as the loads on the units. These are basic rules of synchro operation.

### Control transformer

The control transformer has its shaft driven by some member and delivers a voltage from its  $R_1R_2$  leads, Fig. 4. The synchro generator and synchro motor both have salient pole or "dumbbell" rotors, but the control transformer has a cylindrical rotor, i.e., it offers uniform reluctance to flux regardless of the direction the flux passes through it. The winding is accomplished by winding a two-pole coil into slots in the rotor connected to slip rings.

Assume that there is no electrical load placed across the R leads of the control transformer. A flux vector is set up in the stator of the control transformer, which thereupon aligns itself with the rotor of the generator. The voltages of the two stators are the same since they are connected by wires. Regardless of whether the energy comes from the rotor or the stator there is an ac flux set up which assumes the same angle with respect to the stator of each unit.

As the rotor of the generator turns, the flux vector in it is moved around and the voltages on the S leads change so that a similar flux vector is set up. Now, if the rotor of the control transformer is placed so that no flux linkage passes through its coils there will be no voltage generated across the R leads. If the rotor is moved either counter-clockwise or clockwise, there will be a linkage of flux and a voltage set up in the rotor. Generally, windings of the stator or rotor are such that the output voltage in the R leads is a sine function of the angle moved.

### Differential synchro

The control transformer generally has a higher impedance than a synchro motor and does not tend to coerce the synchro generator. The voltage from the rotor of the control transformer is used to actuate devices that control the angular position of its rotor shaft. These devices are generally known as servo mechanisms and they are growing in popularity.

The differential synchro has a stator very similar to the other

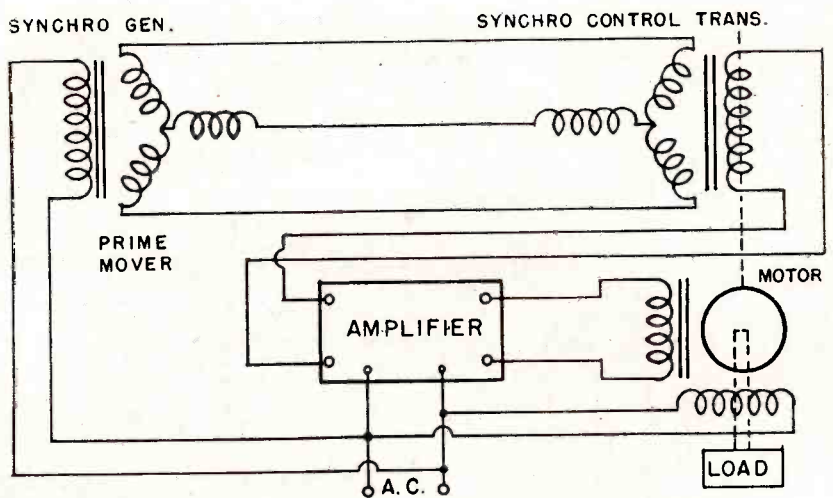

Fig. 11—Servo system including generator, control transformer and motor

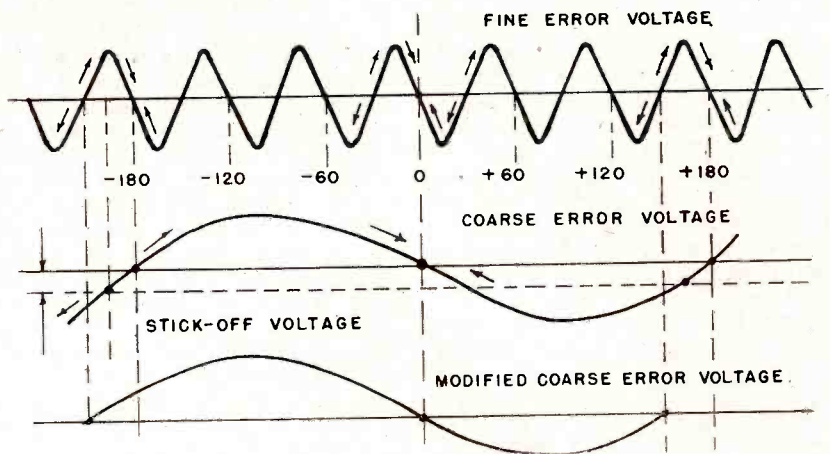

Fig. 12—Introduction of stick-off voltage in two speed synchro system

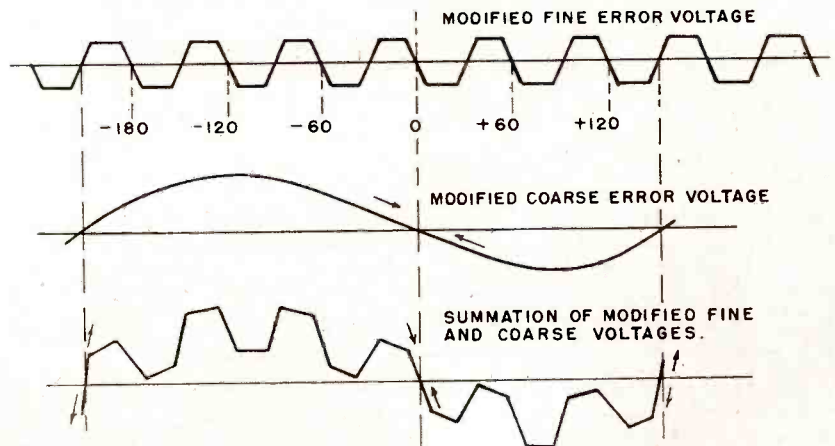

Fig. 13—Clipping of fine error voltage to maintain its initial slope and accuracy

three units mentioned, the synchro generator, the synchro motor and the synchro control transformer. Its rotor, however, is different from any of the others, being cylindrical with a three phase, 120 deg. spacing, Y connected winding brought out through three slip rings. It is

shown in Fig. 5 as a ring winding for simplicity.

If the S leads of this unit are connected to a synchro generator, there will be a magnetic flux set up that has a position that corresponds to the rotor position of the synchro generator. Consider the

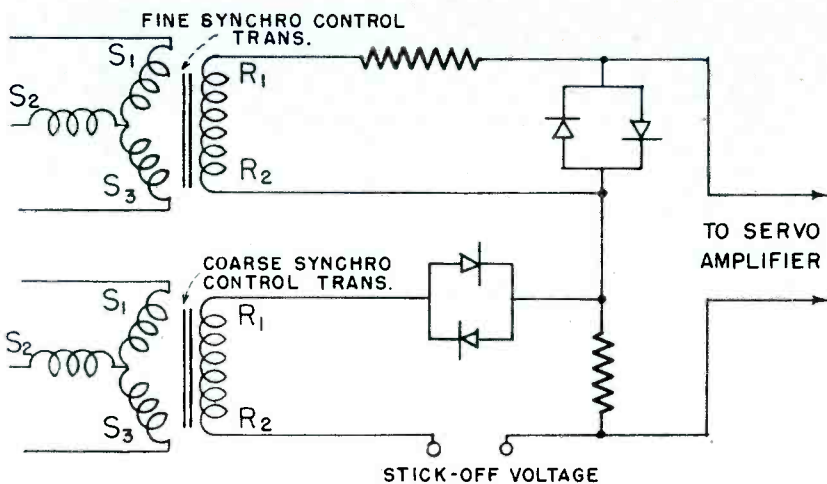

Fig. 14—Two speed synchro mixing circuit using copper oxide rectifiers

stator in this case to be the part that rotates the exciting magnetic flux vector. This, of course, is being done by the generator connected to the S leads of the stator.

Now as this flux vector rotates the three phase winding of the rotor, it acts similarly to the three phase windings on the stator of the synchro generator. The output of the  $R_1R_2R_3$  leads of this synchro differential depend upon the position of the rotor itself, and depend on the position of the generator that is exciting it. Thus if we turn the rotor of the synchro differential we can cause the electrical voltages to be modified in such a way that they will represent a new angle, different from that of the generator.

This device, as the word indicates, acts as a differential and can be inserted between a synchro generator and synchro motor. The syn-

chro motor will then take up a position which corresponds to the synchro generator, plus or minus the angle put in on the rotor of the synchro differential. This synchro differential can be used either as a synchro differential motor or as a synchro differential generator, as we will see a little later. It can, of course, also be modified by merely using one of the windings of the rotor, so as to make it act as an ordinary synchro motor or ordinary synchro generator.

A schematic wiring diagram of a synchro generator operating through a synchro differential generator to a synchro motor is shown in Fig. 7. Several variations can exist. Since the units on the end are identical, we cannot tell by looking at them whether they are generators or motors. If, for example, the one on the left is a synchro generator and the one on the

right another synchro generator, then the differential in between must be a synchro differential motor. The differential motor is identical to the synchro differential generator except it has an anti-hunt damper (or Lancaster damper) on it. It can be used, however, as a synchro differential generator.

Taking another case, let the one on the left be a synchro generator and the one on the right a synchro motor. Now the differential in between cannot be a motor any more but must act as a generator and have its shaft mechanically driven. Here again it adds or subtracts from the angle transmitted by the generator and the motor takes up either the sum or difference of the rotation of the rotor in the generator and differential generator.

### Differential schemes

A third condition can be used by modifying this diagram just slightly. Suppose the unit on the extreme right is a control transformer. Naturally its R leads would not be connected to ac. The unit on the left would then be a synchro generator and the one in the middle, a synchro differential generator. Then the zero position or the synchronous position of the synchro control transformer would then correspond to the sum or difference of the rotor position of the synchro generator on the left and the synchro differential generator in the middle.

The advantage of inserting a synchro differential generator (an electrical unit as against a mechanical unit) is that it does not have to be located close to either of the other units. When the differential is used the large number of units in one data system causes the power factor to get quite bad and this condition can be improved with the synchro capacitors.

### Component solver

Another application uses a generator at each end and a differential indicating the difference between their two positions. The differential is, in this case, a differential motor and has its shaft free to turn. It may carry a dial, contacts to operate electrical apparatus, or it may operate hydraulic valves, etc. However, the differential motor will coerce or put reflected torque back on both generators.

It is interesting to observe that the synchro generator can be used as a component "solver." If an ac voltage is connected to the rotor it will excite voltages in the stator windings, as in Fig. 8. Now if these stator windings are broken up into a two-phase positional voltage instead of three-phase positional

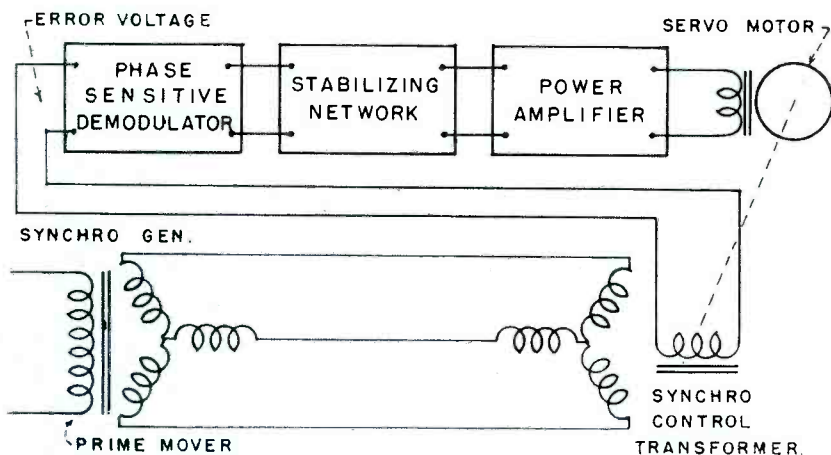

Fig. 15—Error voltages are put through a demodulator and stabilizing network

voltages, then the output from this Scott connected transformer will be proportional respectively to the sine of the angle of the rotor and to the cosine of the angle of the rotor and the magnitude will depend on the magnitude of the ac voltage on the rotor itself.

Another use of a synchro is to cause the phase to be controllable, rotating it according to the angular position of the rotor Fig. 9. This is accomplished by placing three phase power on the stator and taking single phase off the rotor, controlled as to phase through the whole 360 deg.

The phase can be shifted continuously in either direction by simply rotating the rotor. It is best to use units that have cylindrical rotors such as in a synchro control transformer, since the magnetic vector must rotate and it does not rotate well with the salient pole construction.

### Amplifiers

In Fig. 10 a synchro generator is connected to one or more synchro motors. There is an isolation in this case between the generator and the motors, by connecting in the S-leads, unity gain electronic amplifiers. The amplifiers supplying only power, will reproduce the voltages generated in S-leads of the generator. In this system, a small generator can operate larger synchro motors or several of them, depending on the power output of the amplifiers. The advantage of this system is there is no reflected torque that can cause the synchro generator to be coerced, since input to the amplifiers can be high impedance. It is also possible to get an increased torque gradient out of synchro motors.

### Servo mechanisms

The next use, and one that is growing in popularity, is the generator and control transformer combination. The generator receives mechanical shaft angle information and converts it to electrical voltages. These voltages are transmitted to the control transformer, which gives out an electrical voltage indicating whether its shaft is in agreement with the generator shaft or not. If it is not, there will be an electrical voltage from it that can be put on the input of an electronic amplifier and used to control servo mechanisms.

A servo mechanism can do almost any amount of work, depending upon its size, since the electrical information from a control transformer, properly amplified, can control guns, control the rud-

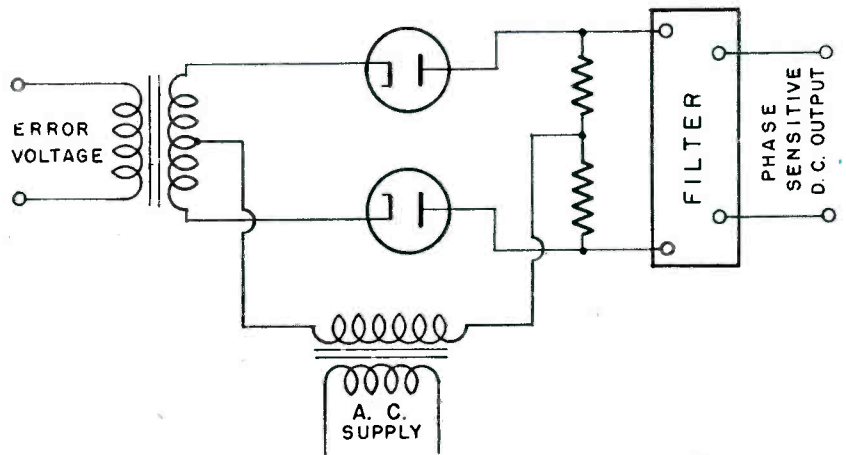

Fig. 16—Half wave diode demodulator used in control of servo systems

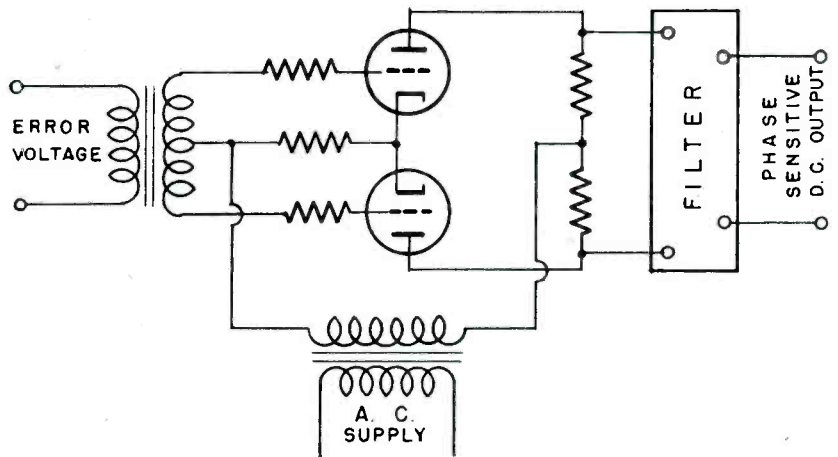

Fig. 17—Triode demodulator. The error voltage is impressed on the grids

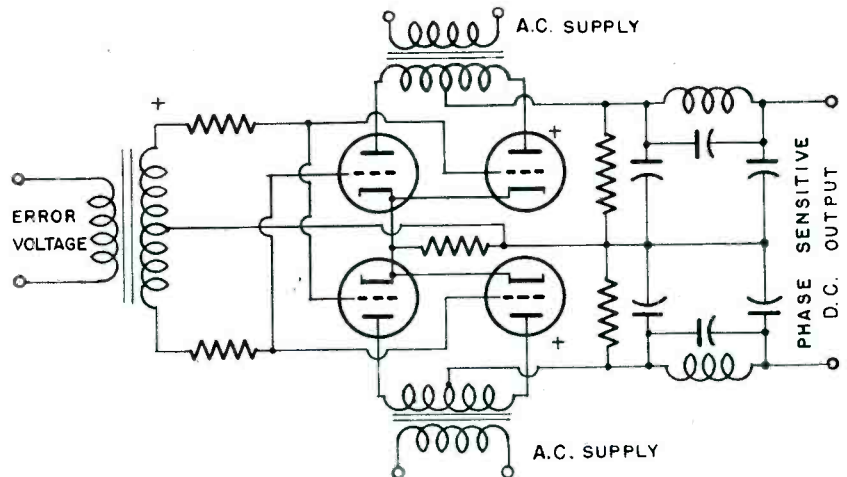

Fig. 18—Full wave triode demodulator. Error voltage unbalances the output

der of a ship and do many things that the synchro motors and generators will not do directly.

The synchro control transformer is most frequently used with a synchro generator, with or without a

differential generator. The voltage from the control transformer is generally amplified and then applied to a servo motor of some kind as in Fig. 11. This servo motor may

(Continued on page 180)

# FM POWER CONVERTER

By **FRANK A. GUNTHER**, Vice-president in charge of Engineering  
Radio Engineering Laboratories, Long Island City, N. Y.

## **Armstrong's design for a transmitter converter unit to permit simultaneous FM broadcasting on two frequencies**

● This device permits simultaneous interim operation on the old, or present, frequency and a frequency in the new FM band between 88 and 106 megacycles. The use of this device was prompted by the FCC's decision of June 27th moving the present FM commercial band up to the range of 88-106 megacycles. The commission has said that it is in accord with simultaneous operation on two frequencies during an interim period. Thus a station operating for the past several years in the 42-50 megacycle band can continue to hold its present audience and by means of an economical and speedy installation of this power converter can transmit the same program on a frequency in the new band.

The converters will be made in two sizes delivering one or three kw. They are separate, independent devices containing their own power supplies and the only connection to the present FM transmitter is by means of a long impedance link line which couples up to 5 or 10 watts of energy at the output tank of the present transmitter. Incidentally, the converter will function on a transmitter of any type or make.

The following operational advantages make themselves apparent. It is desirable to operate on the old and new bands simultaneously in order to eliminate another cart before the horse problem. Since the converter is a relatively simple device, manufacture and installation will be very prompt. In other words, transmission can be started in the 88-106 megacycle band much sooner than if installation of a complete new transmitter were required.

As a matter of fact, spot authorization for construction for a limited number of these power frequency converters has already been applied for from the WPB. We anticipate that the installation of some of these converters will permit regular transmission in the 88-106 megacycle band in time to permit field testing of new receiver models prior to production. In addition, by use of the converter, no new monitoring problems are involved since the frequency devia-

During the course of the recent FCC hearings looking to a solution of the problems involved in adopting definite frequencies for FM operation, Dr. Edwin H. Armstrong let it be known that he had designed a method whereby it became possible to operate an FM transmitter on two frequencies simultaneously—the old, or present, frequency and a new one. He also stated that he had authorized construction of such new equipment. Radio Engineering Laboratories, Long Island City, a pioneer manufacturer of FM equipment, has designed and is now prepared to build the converter described here. — Editors.

tion in the converter output on the new band will be identical to that in the output on the present band.

### **Unit replaceable**

Consideration has been given in the design of this converter to the matter of obsolescence. Therefore, the layout of the converter in final form will be such that the parts actually involved in the frequency conversion unit will be mounted in a removable section of the total unit. At the end of the interim operation, when it is no longer necessary to transmit signals on the low frequency band, these conversion components can be removed and a new Armstrong direct crystal control phase shift type of modulator substituted. The one or three kw final power amplifier of the converter together with power supply and power control systems can be used as part of the new transmitter. We estimate only 15 per cent of the cost of the converter will be lost.

The converter operates on the same principle as any other frequency converter except that it functions on fairly high frequencies and certainly a higher power level than when usual frequency conversion takes place. In addi-

tion, the converter output is tuned to the sum rather than the difference of the input frequencies.

The photograph shows the power frequency converter in its final stage of development in the laboratory, with the various components marked for identification. The unit at the extreme left is a beat frequency oscillator multiplier delivering a constant amplitude signal of about 10 watts, equal to the difference between the new assigned frequency and the old present operating frequency—as an example, a power frequency converter for Alpine—W2XMN, which presently operates on 42.8 and plans to operate simultaneously on 92.1 megacycles. The beat frequency crystal control multiplier will have an output frequency of 49.3 which is the difference between 92.1 minus 42.8. The beat frequency oscillator multiplier has a total multiplication of 12 times, utilizing two doublers and one tripler in order that the basic frequency will be low enough to permit the use of a variable air gap and holder with the crystal.

In place of the small coupling link coupled to the final stage of the present FM transmitter to draw off about 5 or 10 watts of power, a signal generator was used in the laboratory set-up. This put out about 5 watts at 42.8 megacycles and was used to represent the power that would be sampled from the present FM transmitter. This signal generator unit is the second from the left. The output of the signal generator or a sample from the FM carrier, as the case may be, excites a buffer amplifier having one Eimac type 4-125A tube—Class C, delivering approximately 80 watts at the same frequency of 42.8 megacycles to the screen grids of two type 4-125A tubes employed in the converter stage. The screen grids are connected in parallel.

The buffer amplifier is the third unit from the left and the push-pull converter stage is the unit on the extreme right of the photograph. The control grids of the push-pull converter are driven in push-pull by the 10 watt output of the beat frequency multiplier at 49.3 megacycles. The output of the

converter is the sum frequency of the two inputs or 92.1 megacycles and is tuned to resonance in the plate tuning lines at the extreme right. Converter plate voltage is 1,500 and 150 watts output at 92.1 megacycles and is furnished to the dummy antenna. This is, of course, more than enough power to excite the 1 kw power amplifier.

Conversion is accomplished at relatively high power levels in order to reduce the possibility of any stray voltages being introduced in the converter input circuits thus affecting the operation of the converter. Frequency stability of the converter output while inherently exceedingly stable, cannot be as good as just the transmitter alone since the new frequency is controlled both by the present FM transmitter and the frequency converter beat frequency temperature control crystal oscillator. In any event, however, the frequency on the new band will more than meet the FCC requirements.

In the final factory built frequency converter power supplies for the one or three kw power amplifier are at the bottom of the cabinet. Power controls are located on the front panel just above. The buffer signal amplifier and crystal

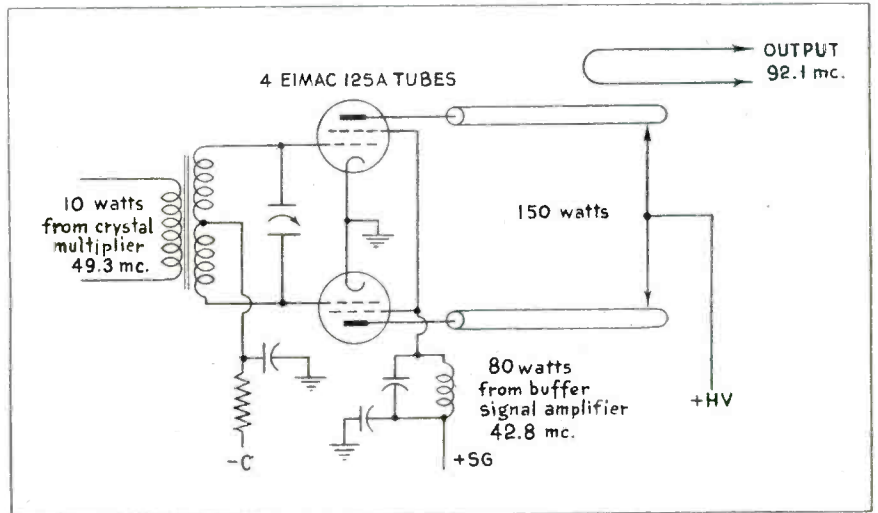

Simplified wiring diagram of the power frequency converter unit showing method of combining outputs at two frequencies to give their sum as the final output frequency of the converter

beat frequency multiplier are mounted in a specially designed shielded cabinet so that these items can be easily replaced with a new Armstrong direct crystal control phase shift type of modulator. Naturally precautions must be taken in design, particularly in regard to shielding, to prevent the radiation of any spurious frequencies.

One further precaution must be

observed and this is in regard to the selection of the frequency in the new band. For example, an FM station presently working on 45.5 megacycles should not select a frequency in the band very close to 91 megacycles, inasmuch as this will be the second harmonic output of their present operating frequency and thus be a cause of difficulty.

The new dual frequency power converter unit as set up in the laboratory for test purposes with the various component units identified. The lower shelf under the laboratory table contains temporary power supplies furnishing low voltages for plate, screen and bias

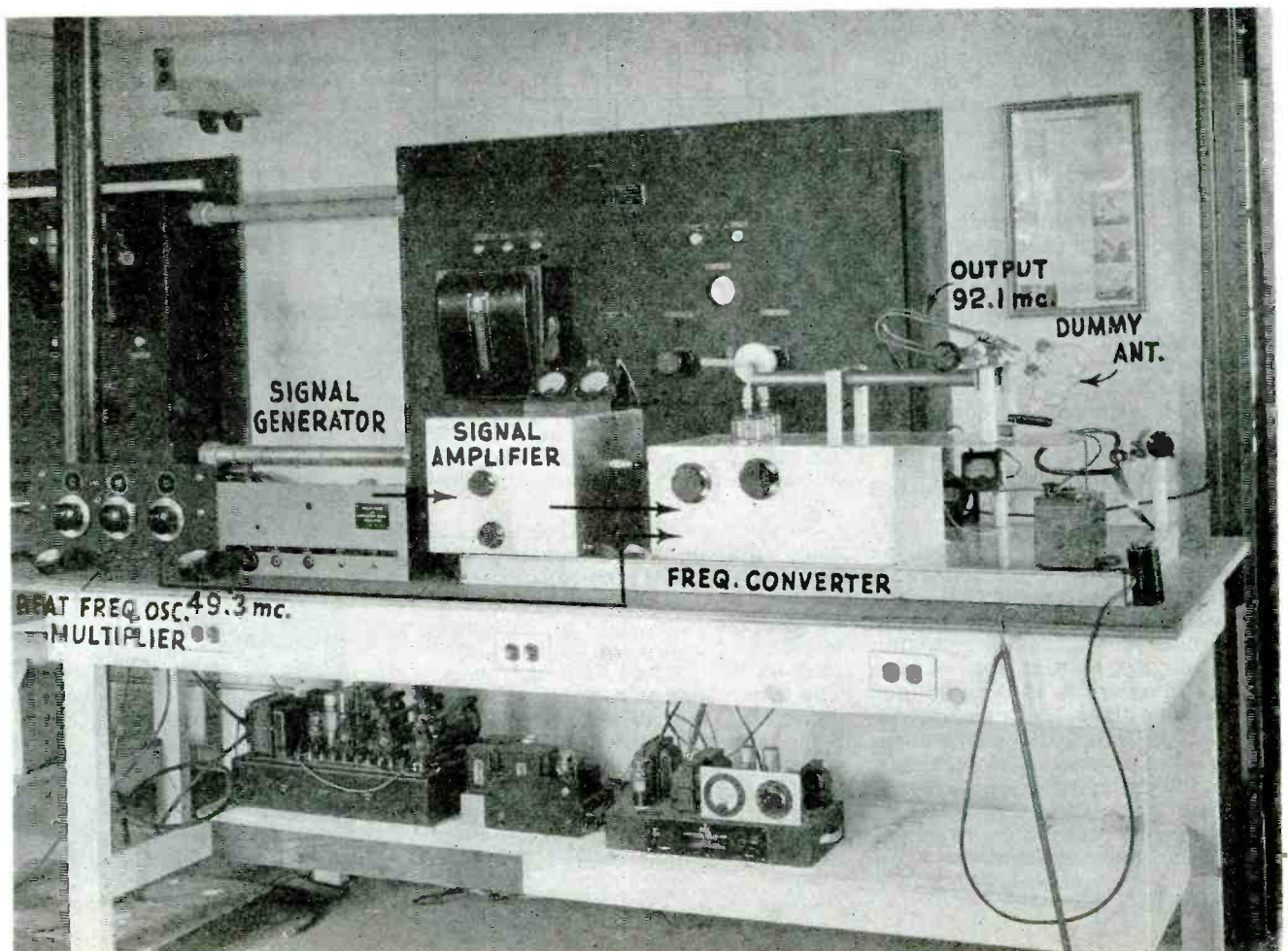

# CRASH FAILS TO

**WNBT, unharmed, transmits at Empire State building**



NBC's Empire State building antennas, before scaffolding was removed, are the new 288mc two-turnstile array at the top with the television sound antenna below it, and below this, the dumbbell turnstile radiator used for both television and FM at once

● In a dense fog, at 9:56 a.m., July 28, a twin-engined B-25 bomber crashed into the 78th and 79th floors of New York's giant Empire State building, causing approximately \$500,000 worth of building damages and killing 13 persons.

NBC's television station WNBT and its WEA-FM occupy the top of this structure, the transmitter equipment being located on the 85th floor. From this point, transmission lines run up to the antennas which top the 102nd-story lookout at a height of 1250 feet above the street level. At the time the accident occurred, a new antenna for high-frequency (288-mc) television broadcasts had just been completed, although no transmitter equipment was yet installed.

## Crash televised

Surprisingly enough, NBC engineers report that no damage whatever was done to their radio and television equipment or the antennas, as a result of the terrific concussion and flaming gasoline which enveloped the top of the tower. However, it is pointed out that, if the plane had crashed ten feet to the west, it would have severed the coaxial cable through which television programs are fed from the Radio City studios. When the engineers were able to reach the 85th floor transmitters two

hours after the crash, no damage was found and the television station was able to go on the air as scheduled at 2 p.m. and by 3:20

forces to which any steel-and-stone edifice may be subjected over a period of years.

Similarly, the equipment of WNBT and WEA-FM was designed and installed with a generous margin of safety. Delicate tubes and other items which could be readily damaged were shock-mounted, so that nothing far short of a direct impact could have put them out of order. The three antennas, which project from the absolute top of the building, were designed to resist a 100-mph gale while covered with sleet, with a 4-to-1 safety factor.

## Radar (?) inoperative

Although the plane had been in radio contact with the LaGuardia Field dispatcher until a minute or two before the crash it is difficult to state what caused the plane to go astray. Carelessness could have been a major factor, but it seems unlikely that two high-ranking

Fog-shrouded top of the Empire State building, and smoke following fire caused by the crash which narrowly missed NBC facilities

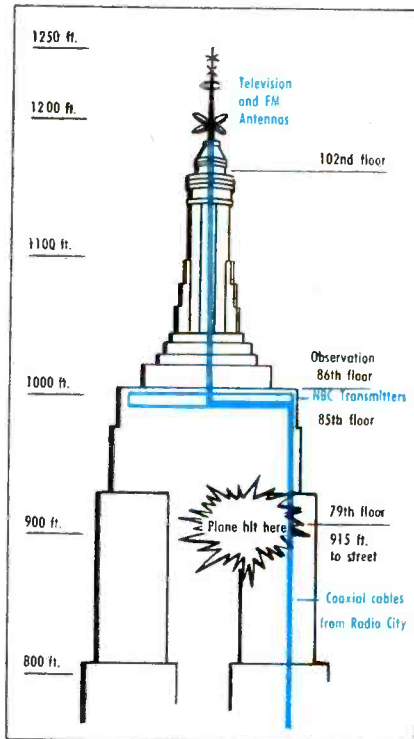

Scene of the unique accident diagrammed to show proximity of coaxial cable feeder between studios and transmitter and transmission line leading to the antenna arrays

p.m. was actually transmitting pictures of the accident.

The tremendous blow that the building sustained is evidenced by the fact that the airplane weighed about 30,000 lbs. and was traveling at a speed of approximately 200 mph.

To some extent, the fact that no radio equipment was damaged was just a matter of extraordinary good fortune. But, on the whole, the lack of damage was due to a sound building structure and careful planning on the part of NBC engineers. The tower, though rocking a foot or more, was able to absorb the terrific impact of the B-25, without suffering extensive damage beyond the two floors that were in the line of flight, because it was flexibly constructed—so as to prevent fatigue due to high winds and other





# STOP NBC TELE STATION

**pictures of bomber crash  
immediately after disaster**

Army officers (such as the pilots of the B-25) would purposely flaunt regulations against low-flying or ignore their instruments while over a city like New York in a fog. Possibly the accident was due to a defective altimeter; it is a well-known fact that the pressure-type altimeters, which are so widely utilized in current aircraft, can be extremely inaccurate. Experts declared unlikely that the B-25 carried any modern and efficient radio-echo altimeter equipment. And if the airplane carried radar, certainly it was not in use because there was no radio or radar operator aboard.

## **Protective equipment**

Shortly after the accident occurred, a newspaper syndicate released a story which stated that the Empire State building had been the recent scene of experiments with the "Stratoscope," a vertical separation indicator developed by Dr. Marcel Wallace of Panoramic Radio Corp. for the purpose of warning aviators who (because of fog and other adverse conditions) do not realize they are flying too low over cities and mountain areas. This report was in error in stating that the Empire State tower was

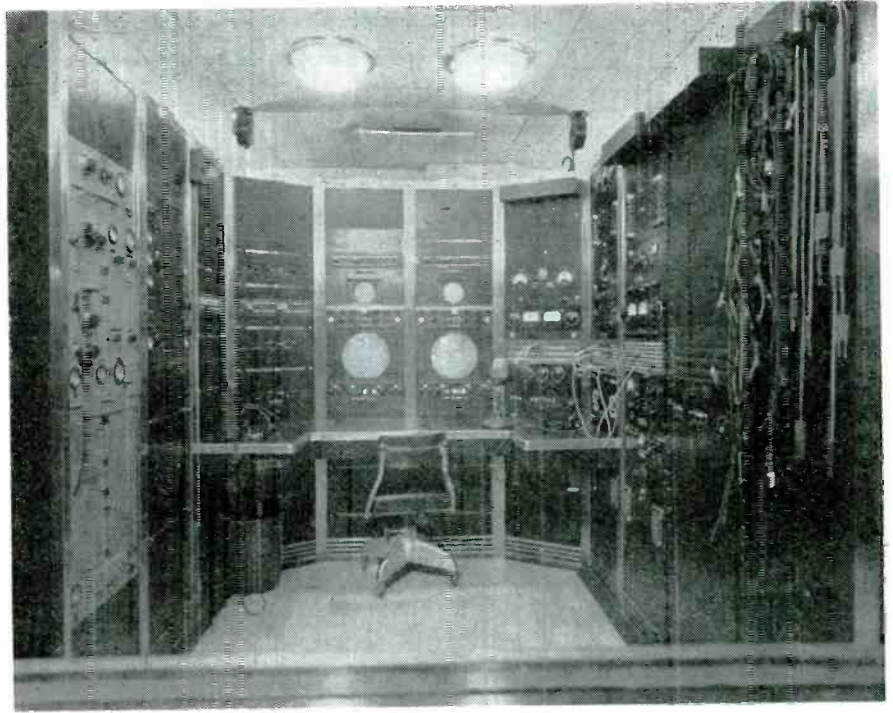

General view of the National Broadcasting's control room for television and FM broadcasting which is located on the 85th floor of the Empire State building and escaped crash damage

the scene of recent tests. But due to the fact that the Civil Aeronautics Administration has achieved satisfactory results from experiments with the Stratoscope,

it seems likely that some such device will be utilized for protecting high buildings in the very near future, according to Glen A. Gilbert, chief of the CAA air-control division.

Evidence of the terrific impact with which an Army B-25 bomber crashed into the upper floors of the Empire State building is revealed by these photos which show the great, gaping hole torn in the north side of the 79th floor, six floors below the NBC installation, and at the right, a view made from above the location of the catastrophe showing the extent of the damage to the two floors involved in the invasion

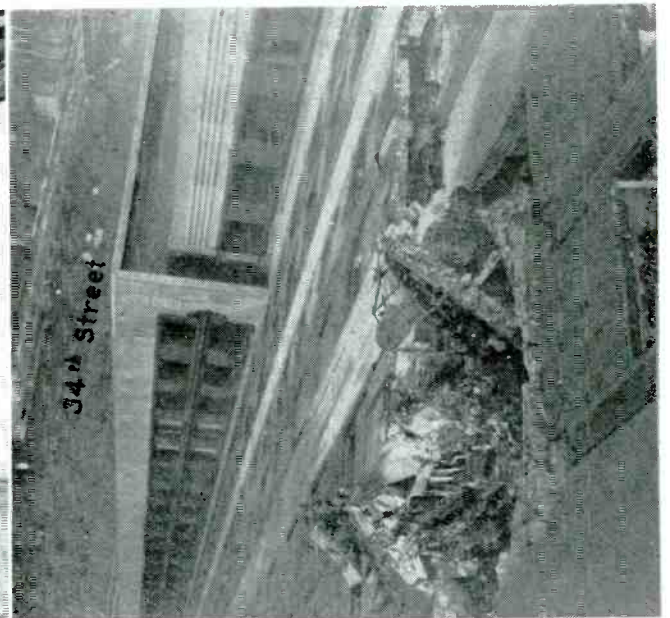

# TELEVISION vs. FOLIAGE

**Cases where set-owners in wooded areas have had video reception impaired April to October. Conditions beyond line-of-sight**

● Surprisingly, very little has been reported or published on the difficulties which summer foliage interposes on home television reception in wooded suburban areas. Yet such foliage blocking will undoubtedly be one of the irritations which outlying video viewers will suffer when television later arrives in force, with millions of sets in use.

Home television users in suburban areas (where reception has been excellent all the preceding Fall and Winter) may, come Spring, note that their picture quality has dropped off, images have become weak and unstable, and the video screen, even when turned up full, remains flecked with "snow."

(See also footnote on international-band interferences, at right.)

One staff member of Electronic Industries has a television receiver located 30 miles from New York City. During the winter on antennas 15 and 35 ft. high he received excellent television from all New York City stations. In April, difficulty began to be experienced, and by V-Day, May 8, video signal strength was badly impaired, while interfering international signals muddled the picture so as to make it hardly endurable to watch.

After calls to local stations to ask their engineers whether any reduction in station power had been made, the explanation of the foliage as an interfering factor was finally struck upon. But no specific

references to this phenomenon could be found in any current literature or in pamphlets on television-set installation and operation. Letters to leading television engineers, however, brought out experiences similar to those already recorded above. Paragraphs of some of these statements follow:

### Engineers comment

**I. J. Kaar**, manager receiver division, General Electric Co., Bridgeport, Conn.—"I have had exactly the same experience as you report. About three years ago I moved from the city, where I had enjoyed excellent television reception, out into the country, where my house is largely surrounded by trees. I moved in the very early Spring, and television reception in the country at that time was quite acceptable, although not as good as in the city. However, when the foliage began to appear on the trees my reception dropped off noticeably, and by the time all of the leaves had appeared the signal had practically disappeared.

"I think there is no question but that foliage acts as an effective barrier at 50 megacycles, so I see only two possible solutions to your problem: 1) Cut the trees down. 2) Put up an antenna high enough to give you line-of-sight again. However, I believe the foliage will not be a major problem when we have more transmitters operating. Certainly in any partic-

ular location a person should have line-of-sight to at least one transmitter. Of course, the problem is going to be aggravated as the frequencies are increased.

"I am not sure that the end of the shielding action will occur in August or September when the sap leaves the trees and leaves. When one interposes a dielectric in the path of a propagated wave, several things happen:

1. Some reflection takes place, depending upon the angle of incidence.
2. Some transmission takes place through the dielectric.
3. Some loss takes place in the dielectric if it is not perfect.
4. A phase change is imposed upon the transmitted wave.

"Thus interposing leaves or other

### Footnote On International Band Interference

And if strong signals on the international band (10 and 12 mc) are receivable in the television set owner's vicinity, he will further discover that his television set is picking up these international signals through its intermediate-frequency circuit, with the result that his video picture is badly spoiled by a series of disturbances, such as: oblique lines, vertical black bars, white tails on all images, and a general destruction of picture quality which makes television viewing most discouraging.

Such international interference may be receivable all year round at the viewer's location, but as long as the video field-strength is high, the interfering signal may have little effect on the picture. But in the Spring with the rise of the sap and the breaking out of leaves on the trees, a leafy barrier 35 to 40 ft. high is set up between the receiving antenna and the video transmitter. This foliage barrier shields out the video waves (50 to 90 mc) but interposes little or no blocking of the interfering 10 mc international-band signals, so that the interference ratio rises sharply.

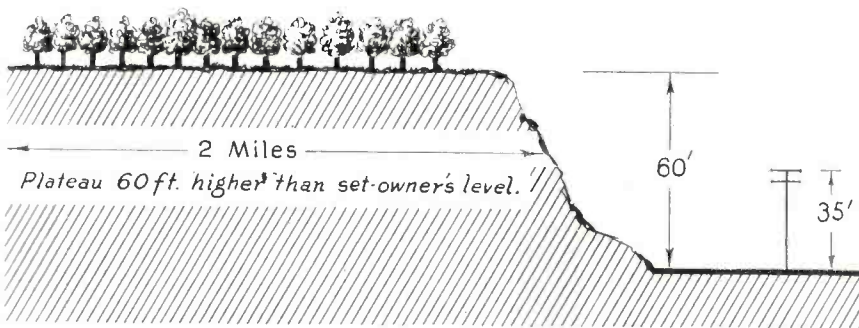

Diagram illustrating case of television-set mentioned above. Dipole-reflector array, located about a mile beyond intervening plateau, and on ground 60 ft. below its level, received good signals all winter. But when trees and underbrush broke out into solid foliage in April, signal was greatly reduced. Antenna height of 75 ft. or more would probably have restored former reception conditions

vegetable matter in the path of a wave is in effect putting up a rather 'lossy' dielectric in the path of the wave, even though the matter does not contain sap. Therefore, one would expect to incur some rather severe losses, whether the leaves and trees held sap or not, although from experience I can say that the amount of loss rises rapidly as the leaves come on the trees. I am not sure that this is because of the sap, or because of the fact that more dielectric has been inserted in the field."

### Leaves and sap cause trouble

**O. B. Hanson**, vice president and chief engineer, National Broadcasting Co., New York, N. Y.—"With respect to your report about the effect of foliage upon the propagation of very high frequency waves used in television broadcasting, I can check your experience and have made the observation over a number of years that as soon as the leaves come out on the trees, the signal strength of all television stations drops at my home in Westport, Conn. (40 miles from New York City). During the winter I receive satisfactory signals from DuMont and WNBT, with CBS not too usable. As soon as the leaves come out, the signal strength of all three stations drops, and the CBS and DuMont signals are seldom usable, although WNBT remains sufficiently high to deliver a good picture. I must assume that this is due partly to the physical effect of the presence of the leaves and partly due to the moisture content increasing in the trees due to the rising sap.

"I do not recollect now any specific quantitative studies made on this subject, but some years ago the Bell Telephone Laboratories made a report on the subject. This mentioned the presence of strong standing wave patterns on the edge of wooded areas, particularly when the leaves were out. As to whether the dropping in signal is due to actual attenuation of the wave, or whether it is due to the increase in amplitude of the standing waves, I am not prepared to say; it is probably a little of both. If it were due to standing waves only, a small shift in the location of the receiving antenna might improve your reception, as your antenna might happen to be located where two waves 180 degrees out of phase happen to meet, thus reducing the signal strength at that spot.

"I think it is generally conceded that as the frequency increases, particularly up to 500 or 1,000 megacycles, the intensity of waves passing over the terrain, wooded areas, rolling hills and buildings will suffer more attenuation than at

### DIFFICULTIES OF SUMMER RECEPTION WILL BE OVERCOME

While loss of picture quality must be expected by suburban set-owners, particularly those beyond line-of-sight, during the foliage months, present difficulties from weak signals and interference, will undoubtedly be overcome by

- Higher transmitter powers
- More tele-transmitters
- More sensitive receivers
- Protected intermediate frequency
- Provision of rf stage to increase selectivity

the lower frequencies; and this, of course, would be more noticeable when the wave becomes tangent to the horizon.

"I, likewise, this summer of 1945, am having a great deal of interference from international broadcasting stations; the amplitude of the signals seems to be higher. This is probably due to a decrease of the field strength of a television signal which causes the automatic volume control to increase gain in the IF stages."

**F. J. Bingley**, chief television engineer, Philco Corp., Philadelphia, Pa.—"Vegetation does have a noticeable effect upon the propagation of television frequencies. As I recall it, there has been reported a reasonable variation supposed to be brought about much in the fashion that you surmise, due to the presence of sap-filled twigs and foliage. The effect was believed to be particularly bad in the case of vertical polarization, though I suppose it would still exist to some extent even with horizontal polarization.

"This probably leaves the suffer-

ing television-set owner with very small comfort since there really are only two ways of overcoming the difficulty, and only one of these is practical, namely the erection of a higher tower.

"With respect to towers of this type, we have had rather good experience with the triangular steel towers manufactured by several concerns. We have found that a 100-ft. tower of this type, properly guyed, is very satisfactory. They are also not very expensive."

### Line-of-sight important

**Albert F. Murray**, consulting television engineer, 1616 16 St., N.W., Washington 9, D. C.—"Concerning the attenuation of television signals by leaves on trees, there occur to me three different instances, two indicating the probable seriousness of such absorption and one case where measured results do not so indicate. It should be borne in mind that the antenna at your home (30 miles from New York) is located beyond the line-of-sight, and that the wooded ridge where the leaves probably play the most important part in reducing the television signal, is possibly acting as a natural barrier between the transmitter and your antenna. In such a location the leaves on the trees could have a very much greater effect on the received signal than if they were located around your home and you lived in a location in sight of the transmitting antenna.

"(A) In 1931 in Camden, N. J., RCA Victor was broadcasting television signals from its first experimental transmitter to a field test station located in a suburban area about six miles away. Good signals were received and many satisfactory demonstrations were made while there were no leaves on the trees. After a few months of inactivity tests were resumed, but we found that the signal strength had dropped nearly to zero. To restore

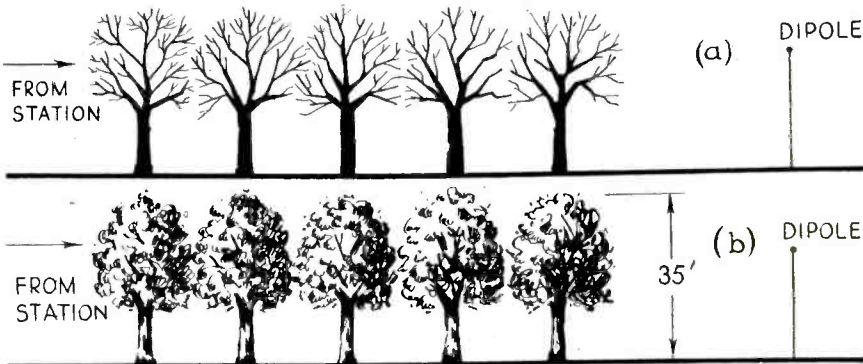

a. Dipole at right receives good television signals through bare limbs of trees, from October to April.  
 b. But when sap rises and leaves break out, the mass of foliage, if thick enough, greatly attenuates video signals (also FM) in the 50 to 100 mc range (meanwhile passing 10 mc international signals which cause bad video interference by entering the television set through the intermediate circuit). Television picture may therefore become poor and subject to bad interference April to October

the signals to a usable intensity it was necessary to increase power at the transmitter and to raise the receiving antenna about 15 feet higher. However, we were never able to prove that the leaves were the determining factor between success and failure.

"(B) Radio men returning from the Pacific say that portable radio transmitters operating on frequencies somewhat below the television frequencies have a range of say 9 miles over the sea but a range of only 100 yards inland. This attenuation is definitely due to jungle growth. This serious situation in the tropics where UHF waves can cover such restricted ranges has been investigated by several groups. The writer has suggested a demountable antenna support which will elevate the usual dipole antenna a reasonable distance above the jungle roof. In this way the line-of-sight would be established between the transmitter and the receiver.

"(C) Engineering tests made at frequencies in the upper end of the television band indicate that where trees surrounded the receiver dipole and-overshadowed it by as much as 20 feet the presence of the trees introduced an attenuation of about 12 db when vertical polarization was used. Upon changing to horizontal polarization (as employed in television broadcasting) the measured loss was reduced to 1 db. This quantitative information indicates that we should find very little effect from the leaves on the trees."

### Check reception in Fall

**Capt. William C. Eddy, U.S.N.,** Balaban & Katz, 190 N. State St., Chicago, Ill.—"Your comments relative to the effect of foliage on television reception intrigue me. I am extremely sorry that during my Navy tie-up I cannot run any tests to prove or disprove this theory. I can well see, however, that sap-filled twigs and foliage, especially damp foliage, can act as either a "window" or partial shield to television radiation.

"This would be particularly true if the frequencies were higher than those used by NBC, WABD, and CBS, but my reasoning is that if it happens in the VHF spectrum it could easily happen at lower frequencies.

"I would be interested in hearing from you in the Fall when you have had a chance to check this phenomenon further, to find if former conditions reassert themselves. My guess is that you have hit on something in the field of radiation."

**P. A. Goetz,** technical supervisor, WCBW, CBS Television, 15 Vanderbilt Ave., New York 17, N. Y.—"I believe you are quite right in your conclusions concerning the effects of dense foliage as I have heard of similar experiences. I have also noticed a comparable effect in some 56-mc amateur transmissions during the summertime, while reception during the winter has been excellent.

"In television reception at my

home, also, I have a somewhat similar situation and have tracked down the interference at one time as coming from the short-wave transmitter in Cincinnati.

"There are two possible ways that this interference may be overcome. Raising the receiving antenna is one method. Complete shielding and the use of a pre-selector and intermediate-frequency trap circuits is another."

**Dr. H. T. Stetson,** Massachusetts Institute of Technology, Suburban Laboratory, Needham 92, Mass.—"I am tremendously interested in your experience with blocking of television signals by the rise of sap and the breaking out of foliage.

"We have been measuring the conductivity of a birch tree outside the laboratory here at Needham every hour on the hour throughout the day, since February, 1944, but I had not thought of this as having anything to do with our radio propagation studies. Now I see that this matter of tree conductivity is definitely related to television reception.

"Incidentally the sap as measured by our conductivity meter started up a whole month earlier this year, and I am informed by Dr. H. S. Burr of Yale (see *Electronic Industries*, December, 1944, page 82) that Vermont syrup makers report the same phenomenon."

\* \* \*

The editors of *Electronic Industries* will welcome further reports

(Continued on page 194)

### \*ENGINEERING FOR POSTWAR

# NOMOGRAPH for Q METER

• The conventional Q meter is designed to indicate directly the Q value for various inductances which can be connected across a calibrated tuning capacitor tuned to resonance. Where it is desired to determine the Q of capacitors or the Q for a standard capacitor using different types of dielectrics, the usual procedure is to connect the capacitor to be tested across the terminals of the Q meter which are connected to the internal calibrated capacitor.

When an unknown capacitor is connected across the calibrated capacitor of the Q meter, the Q of any given circuit which may have been set up on the Q meter will be reduced by the shunting effect of losses of the component under test.

On the next page a nomograph is shown for calculating the effective value of the  $Q_s$  of the component connected across the capacitor terminal of the Q meter.

To make use of this nomograph, the data from the Q meter are determined in the following manner. Connect a coil preferably with a high Q to the coil terminals of the Q meter and set the calibrated capacitor of the Q meter to a value larger than the value of the capacitance to be tested by at least the minimum reading on the Q meter capacitor dial (usually about 30 micromicrofarads).

That is, if it is desired to check the Q of a capacitor approximately 100 micromicrofarads set the Q meter capacitor dial at approximately 150 micromicrofarads and adjust the frequency of the Q meter signal generator to resonance as indicated by the maximum Q reading for the circuit. This value of Q which is the Q of the coil circuit primarily, is called  $Q_1$  and the capacitance as indicated by the calibrated dial is  $C_1$ . The capacitor to be tested is then connected across

the capacitor terminals on the Q meter and the calibrated capacitor dial is turned until resonance is again indicated by maximum reading of the Q indicating meter. The new reading of the Q indicating meter is  $Q_2$ . The new reading of the calibrated capacitor dial is  $C_2$  and will differ from  $C_1$  by the value of the capacitance connected across the circuit.

After these four quantities  $Q_1$ ,  $Q_2$ ,  $C_1$  and  $C_2$  have been determined, the nomograph on the next page can be used to determine the  $Q_s$  of the sample connected across the terminals.

Proceed with the determined data as follows. Divide  $C_2$  by  $C_1$  and locate this point on the fourth scale from the left of the nomograph. Where the quantity being tested is a capacitor,  $C_2$  will be smaller than  $C_1$  and the ratio will be less than 1 and will be located on the right hand side of this scale. With a



# GLOSSARY OF COMMON

Compiled by the Editors of Electronic Industries

**A dictionary of technical and military terms used to identify various kinds of radar equipment, their parts and uses**

**A**—U. S. Navy prefix to designate airborne equipment.

**ASB**—Airborne search radar.

**ABK**—Airborne search radar.

**AYD**—Airborne altimeter equipment.

**AGL**—Aircraft gun laying; radar for plane-to-plane fire control.

**AI**—Aircraft interception.

**Aided tracking**—A system for tracking a signal in azimuth, elevation, or range or all variables together, in which a constant rate of motion is maintained by mechanical means. Operator adjusts an error voltage.

**Anti-TR switch**—A spark gap and transmission line combination which prevents radar echoes from feeding into transmitter.

**ARO**—Lightweight radar range finder.

**A-Scan**—An indicator with a horizontal or vertical sweep, giving range only.

**Automatic tracking**—Servo mechanism tracking.

**Azimuth stabilized PPI**—The presentation of the radar signals on a PPI tube so that north (magnetic or true) is always at the top of the tube.

**B**—U. S. Navy prefix to identify identification equipment. As ABK, etc.

**Back swing**—A portion of a pulse in which the voltage shifts in the direction opposite to that of the main body of the pulse, and occurs at the end of the main body of the pulse. Compare tail and overshoot.

**Bazooka**—A terminating device used to convert an unbalanced line to a balanced line.

**Beacon**—Automatic transmitter operated by a radar signal to enable an aircraft to determine its azimuth and range with respect to the beacon.

**Beam width**—Width (angle between  $\frac{1}{2}$  power intensities) in azimuth of the effective radiation from an antenna.

**Bedsprings**—Broadside array with flat reflector.

**Blip**—Same as pip.

**Blocking oscillator driver**—Circuit

which develops a square pulse used to drive the modulator tube and usually contains a line controlled oscillator (blocking) to shape pulse into square waves.

**Bootstrap driver**—Vacuum tube circuit used to produce square pulse which drives modulator tube.

Duration of pulse is determined by pulse-forming line. Circuit is called bootstrap driver because voltages on both sides of the pulse forming line are raised simultaneously with voltages in the output pulse but their relative difference (on both sides of the pulse forming line) is not af-

## AMERICANIZED BRITISH RADAR TUBE

• When the air war over England was at its peak, that country was badly in need of increased production of a certain radar and radio tube, yet dared not take the time to develop new methods for its manufacture. How an American

company met the emergency for the British may now be told.

The tube, known as the VR-91, as developed by the British not only required materials then critically scarce, but also was not adapt-

(Continued on page 230)

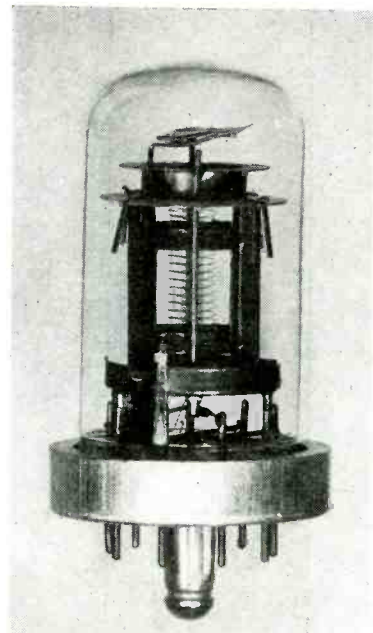

Sylvania's modernized version of the British type VR91 radar receiving tube shown at the left with the shield removed gives particularly good performance in IF and RF amplifiers at over 20 mc

### Characteristics

Heater voltage (nominal)	
ac or dc .....	7.0
Heater current (nominal) ..	0.320
Plate voltage .....	300 max.
Screen voltage .....	300 max.
Plate dissipation .....	3 watts max.
Screen dissipation .....	1 watt max.

### Operating Conditions

Heater voltage .....	6.3
Heater current .....	0.3
Plate voltage .....	250
Screen voltage .....	250
Cathode bias resistor .....	150 ohms
Plate current .....	10 ma
Screen current .....	3.1 ma
Mutual conductance .....	6300 mmhos
Plate resistance .....	0.6 megohm

# RADAR EXPRESSIONS

ected by the considerable voltage rise in the output pulse.

**B-Scan**—Presentation in which signal appears as a bright spot with azimuth angle as the horizontal coordinate and range as the vertical coordinate.

**Calibration marker**—Same as range marker.

**Centering diode**—A clamping circuit used in some types of PPI indicators.

**Choke flange joint**—Nonrigid connection between two wave guides and containing an L shaped cavity.

**Choke joints**—Wave guide joints designed for low losses.

**CIC**—Combat information center.

**Circular scanning**—Axis of the RF beam rotates through 360 deg. in single plane.

**Clamping circuit**—Circuit which clamps either amplitude extreme of a wave form to a given reference level.

**Coax dry load**—A sand-carbon mixture in cable to act as dummy load.

**Conical scanning**—Scanning in which antenna tilt angle is fixed so that the axis of the rf beam generates a cone with a vertex angle usually of 5 to 10 deg.

**Control transmitter**—Selsyn.

**Cosecant squared beam**—Radar beam pattern designed to give approximate uniform signal intensity from distant and nearby objects. Beam is generated by a spun barrel reflector. Intensity varies as the square of the cosecant of the elevation angle.

**Counter circuit**—Circuit which receives uniform pulses representing units to be counted and produces a voltage in proportion to their frequency.

**C-scan**—Type of presentation in which signal appears as a bright spot with azimuth angle as horizontal coordinate and elevation angle is vertical coordinate.

**Cutler feed**—Resonant cavity at the end of a wave guide, feeding energy to reflector of spinner assembly.

**Dark trace tube**—A CRT with screen composed of a halide of sodium or potassium, the traces of which may be enlarged by projection.

**DC restorer**—See clamping circuit.

**Differential selsyn**—A selsyn in which both rotor and stator have similar windings that are spread 120 deg. apart. The position of

the rotor corresponds to the algebraic sum of the fields produced by the stator and rotor.

**Diplexer**—A coupling system which allows a radar and a communication transmitter to operate simultaneously or separately from the same antenna. Not to be confused with the duplexer.

**Direction rectifier**—A rectifier which supplies a direct voltage varying in magnitude and polarity with the magnitude and relative polarity of an ac selsyn error voltage.

**Display**—A CRT screen and dials which present the information obtainable by the radar set; for example, range, azimuth, elevation.

**D-scan**—Presentation combining B and C types. The signal appears as a bright spot with azimuth angle as the horizontal coordinate and elevation angle as the

vertical coordinate. Each horizontal trace is expanded slightly vertically by a compressed time sweep to facilitate separation of signal from noise and give a rough range indication.

**Duplexing assembly**—Combination of TR switch, and sometimes an anti-TR switch, with transmission lines.

**Echo box**—A high Q resonant cavity which receives RF energy through a pickup antenna during the transmitted pulse and reradiates this energy through the same antenna immediately after the pulse. The reradiated energy is picked up by the radar set. Since this energy from the echo box dies off exponentially, it will appear on an A-scope indicator as a flat-topped pulse, resulting from the saturation of the receiver by the high energy re-

(Continued on page 198)

## US-BRITISH RADAR REPORTS ISSUED

● After many months of preparation, the Joint Board on Scientific Information Policy has issued for the Office of Scientific Research and Development, the War department and the Navy department, "Radar—A Report on Science at War." The report, in the form of a 53-page printed booklet contains little of technical data though it does represent the first officially released description of radar development, applications and performance. The booklet is divided into 14 Chapters and an Appendix. Chapter headings are:

- 1—Introduction.
  - 2—How Radar Works.
  - 3—Early History of Radar.
  - 4—War Time Development of Radar in U.S.
  - 5—Radar and Air Defense—The Problem on Land.
  - 6—Radar and Air Defense—The Problem at Sea.
  - 7—The War Against the U-Boats.
  - 8—The Air Campaign Against Shipping.
  - 9—The Strategic Air Offensive.
  - 10—Radar and the Tactical Use of Air Power.
  - 11—Radar in Naval Warfare.
  - 12—Electronic Navigation.
  - 13—Radar Personnel and Training.
  - 14—Radar in the Peacetime World.
- Appendix—Technical Description of Radar Systems.

Although the chapter headings appear to indicate inclusion of a wealth of revealing material, the text does not live up to the promise. For the most part information given already is fairly common

knowledge, though some revelations regarding the effectiveness of radar have been included. Simultaneously the British Information Services issued a 30-page booklet entitled "RADAR." The story of the part played by this instrument in the battle of Britain and subsequently during the war is told dramatically. A few interesting technical details are revealed. For instance, it is stated that the earlier radars and those still used for general searching operated at about 200 mc whereas later developments were with waves of only a few centimeters length.

It is well known that successive artillery shells from one gun do not all fall on the same spot but create a cone of fire. The booklet points out that the accuracy of location achieved by the newer radar sets for gun ranging is better than the ballistic accuracy of the artillery. The use of radar in the submarine war is told and the loss of German effectiveness when it became possible to discover a submarine periscope sticking up above the surface of the water in total darkness is emphasized. So sensitive have sets become, it is stated that the wriggling of an infantryman on the ground can be detected. Another dramatic achievement was the projection of the aviator's radar patterns on his windshield for night fighting.

# FM-TELE STANDARDS

**FCC engineering proposals, largely approved by industry, provide for 4 classes of tele stations—See FM soon displacing AM**

● Four classes of television stations will be established in the United States under proposed engineering standards adopted by a joint FCC. Because FCC relies almost unequivocally upon its engineering staff for technical recommendations, it is practically certain to approve them. Proposed engineering standards for FM, embracing allocations, topographical data and transmitter location, operating practices, antenna systems were also sanctioned by a group of approximately 100 FCC-industry engineers with one feature decision that the ratio of desired to undesired signals of 10 to 1 for stations operating on the same channel and 2 to 1 ratio for stations in adjacent channels, 200 kc removed, were adopted. The allocations for television had not yet at our press deadline been definitely decided by the FCC, but every indication was that the Commission would approve the allocations plan proposed by the Television Broadcasters Association.

## 400 major tele channels

The television plan calls for assignment of channels for 400 stations in Class A, B and C in 125 of the 140 metropolitan districts of the United States and several hundred Class D stations will be available to serve the remaining metropolitan districts and other areas.

The three-day hearings before the Commission en banc on the economic and social prospects for FM at which the executive heads of the three networks and over a score of other leaders in broadcasting, including Major E. H. Armstrong, FM inventor, and former Commissioner T. A. M. Craven who is now executive vice-president of the Cowles Broadcasting Co., testified, developed the consensus that in the postwar era standard (AM) broadcasting will be replaced entirely by FM except for a few scattered clear channel stations serving remote rural areas.

The broadcasters' spokesmen in general supported the single market plan of horizontal competition in FM which was advanced by CBS. The networks indicated that they do not plan to charge for service to the FM stations until this new form

of broadcasting is fully established. There was general opposition to FCC's proposal of requiring two hours of unduplicated programs for FM because of the expense during the AM-FM transition period, but the FCC asked all networks to submit schedules of programs capable of high fidelity transmission and reception. One network president, Mark Woods of American Broadcasting System, predicted that there would be 4,000 FM stations within five years after the war and that it would take three years for FM to break even financially.

Under the TBA plan, each of the 13 television channels is designated for certain metropolitan districts except Channel No. 1 (44-50 mc.) which will be reserved for low-powered stations serving small communities. Class A stations which may use Channels 2-13 inclusive would be assigned to metropolitan districts with large populations with limited geographical separations in the northwestern region of the nation; Class B stations go to cities with smaller populations; Class C stations will have minimum separation of 170 miles on co-chan-

## WESTINGHOUSE PROPOSES

Plans to inaugurate a new system of television and FM radio broadcasting from stratosphere airplanes cruising six miles in the air, as soon as permits and equipment can be obtained, have been completed by the Westinghouse Electric Corp. and the Glenn L. Martin Co., airplane builders.

The Westinghouse Stratovision system would employ a low-powered ground transmitter to send television and FM broadcasts to specially - designed high - altitude planes circling slowly overhead. The planes would be equipped with

receivers and transmitters for re-broadcasting these programs back to the earth. Each of 14 planes planned for the final arrangement would carry four television and five FM transmitters. A coast-to-coast network for relaying television and FM programs from plane-to-plane between New York and Hollywood would simply require stationing eight such stratosphere planes above strategic areas spanning the continent.

The eight planes in the Stratovision relay system would fly over New York, Pittsburgh, Chicago,

Westinghouse engineers estimate that with 14 planes flying over the centers mapped, it would be possible to serve 78 per cent of the population with four television and five FM programs transmitted simultaneously. At right is shown a cut-away view of one of the specially designed Martin planes as it would appear with the transmitters and necessary monitoring equipment in place

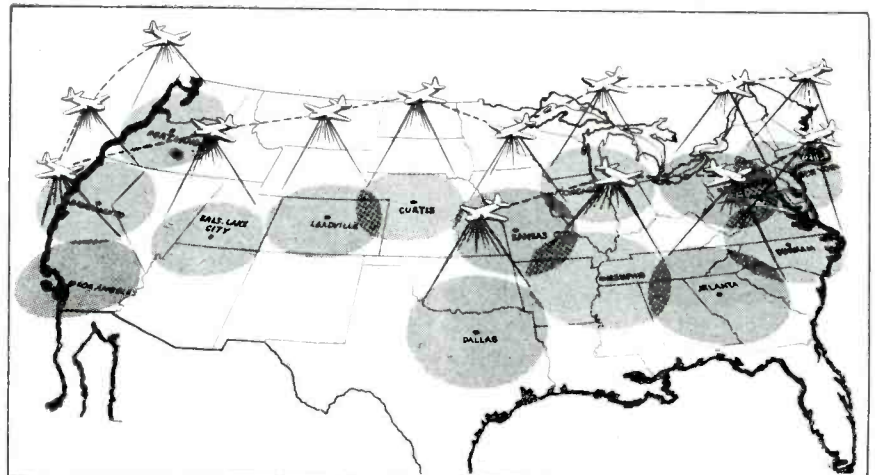



nel basis and 85 miles on adjacent channels from Class A and other C stations and may be assigned Channels 2-13; and Class D stations will serve cities not having adequate service from other classes of outlets.

Under the proposed TBA allocation plan, New York and Chicago each will get seven channels for Class A stations—Channels 2, 4, 5, 7, 9, 11, 13. Los Angeles will get the same channels for seven Class C stations and San Francisco will secure six Class C stations using Channels 2, 4, 5, 7, 9, 11. Philadelphia is to obtain four Class A stations using Channels 3, 6, 8, 10 and Detroit will get the same channels plus Channel 12 for Class A stations.

In the proposed engineering standards, the rules for television transmitters and associated equipment follow very much along the lines of the suggestions of the Radio Technical Planning Board in its reports to the Commission. The

television interference standards are virtually the same as existed under the old FCC rules, while the standards on the service area of stations were only refined and clarified from the previous rules. The field intensity measurement standards, which had not been definitely specified in the present rules, were spelled out in definite detail in the proposed standards to conform with the methods proposed for FM.

In the case of FM, two phases of the standards have been left for further decision by FCC. These included the question of booster or satellite stations and horizontal polarization. In the case of use of a limiting or compression amplifier, the provision of not more than 3 decibels being employed is to be changed as some felt there should be a lower limitation than 3 decibels. The consensus was that there should be a final determination in favor of horizontal polarization in the interests of uniform-

ity, although the discussion at the conference was that it would be better to leave it flexible with permission for vertical polarization for further experimentation. It was also felt that FM profiles up to 10 miles rather than eight miles should be sanctioned.

### Technical standards

The most important Engineering Standards for Television, proposed by the FCC, and agreed to, were those on Transmission standards which follow:

- (1) The width of the television broadcast channel shall be six megacycles per second.
- (2) The visual carrier shall be located 4.5 mc lower in frequency than the aural carrier.
- (3) The aural carrier shall be located 0.25 mc lower than the upper frequency limit of the channel.
- (4) The visual transmission amplitude characteristic shall be as shown in Appendix II.
- (5) The number of scanning lines per frame period shall be 525, interlaced two to one.
- (6) The frame frequency shall be 30 per second and the field frequency shall be 60 per second.
- (7) The aspect ratio of the transmitted television picture shall be 4 units horizontally to 3 units vertically.
- (8) During active scanning intervals, the scene shall be scanned from left to right horizontally and from top to bottom vertically, at uniform velocities.
- (9) A carrier shall be modulated within a single television channel for both picture and synchronizing signals, the two signals comprising different modulation ranges in amplitude.
- (10) A decrease in initial light intensity shall cause an increase in radiated power.
- (11) The black level shall be represented by a definite carrier level, independent of light and shade in the picture.
- (12) The pedestal level (normal blank level) shall be transmitted at 75 per cent (with a tolerance of plus or minus 2.5 per cent) of the peak carrier amplitude.
- (13) The maximum white level shall be 15 per cent or less of the peak carrier amplitude.
- (14) The signals radiated shall have horizontal polarization.
- (15) A radiated carrier power of the aural transmitter not less than 50 per cent or more than 150 per cent of the peak radiated power of the video transmitter shall be employed.
- (16)\* Variation of Output—The peak-to-peak variation of transmitter output within one frame of video signal due to all causes, including hum, noise, and low-frequency response, measured at both synchronizing peak and pedestal level, shall not exceed 5 per cent of the average synchronizing peak signal amplitude.
- (17)\* Black Level—The black level should be made as nearly equal to the pedestal level as the state of the art will permit. If they are made essentially equal, satisfactory operation will result and improved techniques will later lead to the establishment of the tolerance if necessary.
- (18) Brightness Characteristics—The transmitter output shall vary in substantially inverse logarithmic relation to the brightness of the subject. No tolerances are set at this time.

(Continued on page 238)

\* These items are subject to change but are considered the best practice under the present state of the art. They will not be enforced pending a further determination thereof.

## FLYING TELE-FM STATIONS

Kansas City, Curtis, Neb., Leadville, Col., Salt Lake City and Los Angeles, linking logical talent centers in New York and Hollywood. By adding six more planes over Durham, N. C., Atlanta, Memphis, Dallas, Sacramento and Portland, Ore., it would be possible to provide Stratovision coverage for 51 per cent of the nation's area and 78 per cent of its population.

Discussing details of the system Westinghouse engineer C. E. Nobles, its creator, explained: "Programs would be originated in conventional ground studios connected with plane

transmitters by a special beamed-type ultra-shortwave radio link. Similarly beamed plane-to-plane connections would be used to form the nationwide high-altitude relay network.

"Contributing to economy of the system is the fact that as the height of a television or FM antenna is increased, the amount of power required to deliver a usable signal throughout its line-of-sight area is sharply reduced. One kw of power will be sufficient to provide a useful signal throughout the 442 mile

(Continued on page 234)

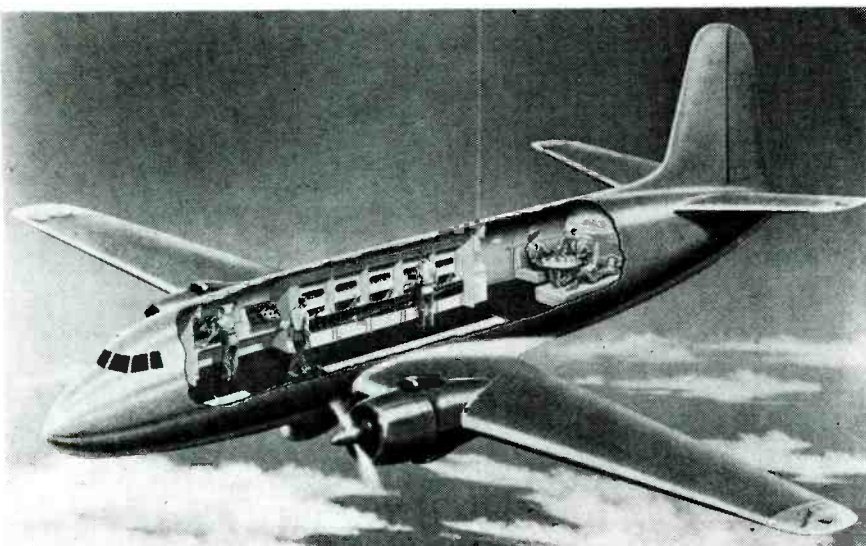

# RADIO DOOR ACTUATOR

By R. G. ROWE

Niagara Falls, N. Y.

**Simple modification of standard automobile broadcast set permits remote control through an induction relay circuit**

• The remote operation of garage doors from a switch or pushbutton on the automobile dashboard has held a fascination for the experimenter for a number of years and several systems have been disclosed from time to time. It seems logical to assume that in the postwar era this field will afford a new market for the volume producers of electronic equipment, provided that some plan of educational advertising is introduced and that the initial cost, as well as the maintenance and operating expense, of the apparatus is kept within reason. It remains for the manufacturers of door actuating equipment to reduce the cost of that portion of the equipment. The electronic engineer is concerned primarily with the design of a cheap, simple, rugged and reliable remote control switch to link the automobile with the garage door operator.

Automatic control systems using electronic methods are among the most important developments in many industries. This article shows how the same technics can be applied to new conveniences for the home. On the other hand, the principles shown here might equally well form a means of speeding up certain operations in factories where doors, gates, etc., must be operated at the approach of certain trucks but be immune to the presence of others. This discrimination may not be readily possible with certain forms of photoelectric control.

It will be appreciated in the art of remote control, wherein a "fixed" station apparatus is to be controlled from a "mobile" remote control station, mechanical or wired electrical linkage between the two points is undesirable. It remains to use some form of linkage between the control and the controlled station whereby relative movement between the two is unrestricted.

Further, it will be understood that, while unrestricted relative movement is desirable, the effective "control radius" may be restricted or limited. In the case of the remote control of a garage door operator, for example, control need be effective only in the immediate vicinity of the controlled apparatus. In fact, limited control radius is a desirable feature in order to prevent false actuation of the apparatus by an undesired control station. These requirements broadly suggest electromagnetic linkage, with light waves or radio waves interconnecting the two or more stations.

While light wave linkage systems using photoelectric methods are relatively inexpensive due to low transmitter costs, they exhibit some major disadvantages. First, the light lens system must be kept clean; second, a clear optical path

Fig. 1—(Upper) shows a type of induction receiver circuit suitable for use in the system described. Fig. 2—(Lower) is a schematic showing of a conventional radio receiver adapted to operate as control transmitter if switch is in right-hand position. Audio section is provided with feedback connection to generate signal applied to loop antenna at the right

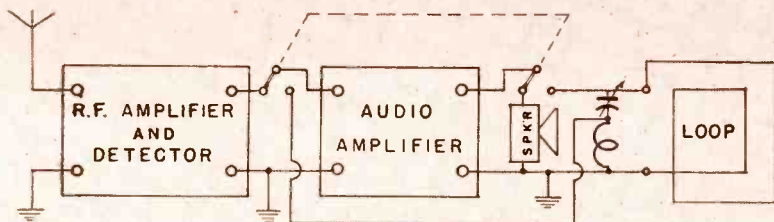
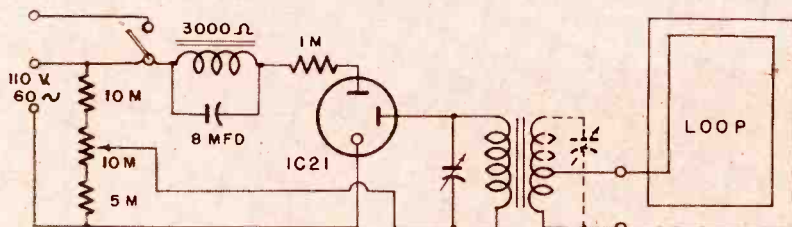
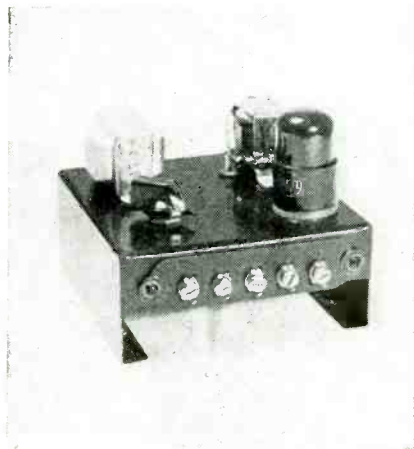

Fig. 1A—Induction receiver-relay unit with sensitivity control is set up inside garage



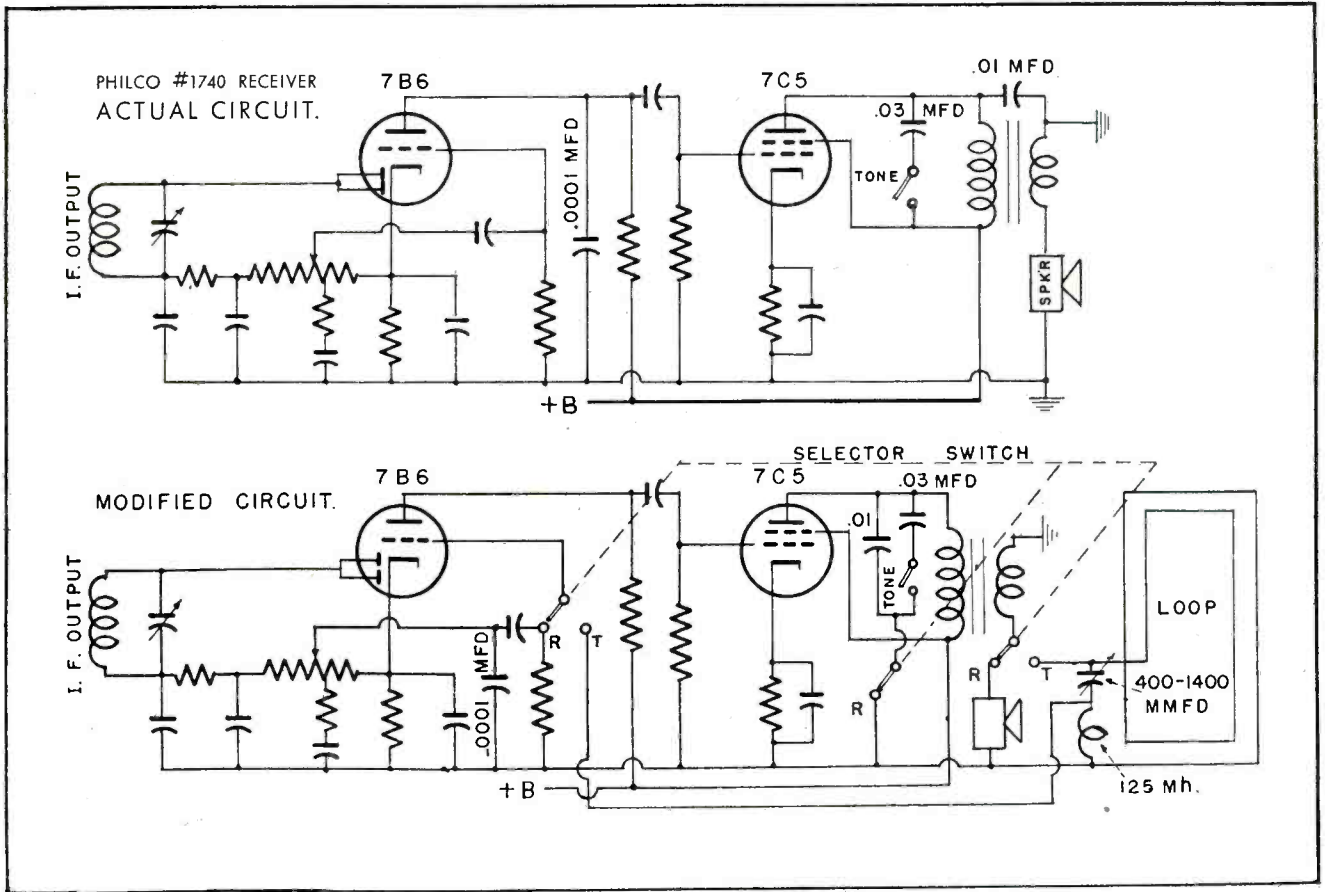

Fig. 4—Upper wiring diagram shows the actual circuit as used in a standard Philco automobile radio set for broadcast reception and the lower diagram shows the modification required to adapt equipment as a control transmitter. Added parts are switch, variable capacitor, choke and loop

between the transmitter and receiver is required; third, the system must be directional for optimum efficiency requiring close optical alignment; fourth, light systems are more easily burglarized; and fifth, it is more difficult to "tune" them to a specific transmitter.

To use radio wave linkage, consideration must be given to the present crowded conditions in the radio spectrum. If the remote control transmitter is capable of interfering with authorized transmissions due to its operational fre-

quency or to a high harmonic wave output, either governmental licensing or the assignment of special unlicensed operating frequencies would be required. Even with the assignment of such frequencies, crowding of the allotted spectrum inevitably will occur when these remote control systems become more popular, unless transmitter radiation is limited. Quite obviously, the radiation may be limited by lowering the operating frequency and using frequencies in the order of 10 to 100 kilocycles.

The cost of receiver-relay appa-

ratus for radio wave, or induction, remote control compares very favorably with the cost of photoelectric-relay apparatus for light wave control. Fig. 1 illustrates an induction relay circuit employing either a 1C21 or an OA4G cold cathode tube. The low impedance receiving loop, which represents a preferred form of antenna system, is buried in the approach driveway. It is coupled through a four- to eight-ohm line and a conventional line-to-grid transformer to the starter anode of the cold cathode tube. (Continued on page 130)

Fig. 3—(Left) This shows the type of loop used and the method of mounting under the car where there is plenty of room for clearance above the automobile differential mechanism. Fig 5—(Right) In modified receiver escutcheon "Door" button might be one of the "push-buttons"

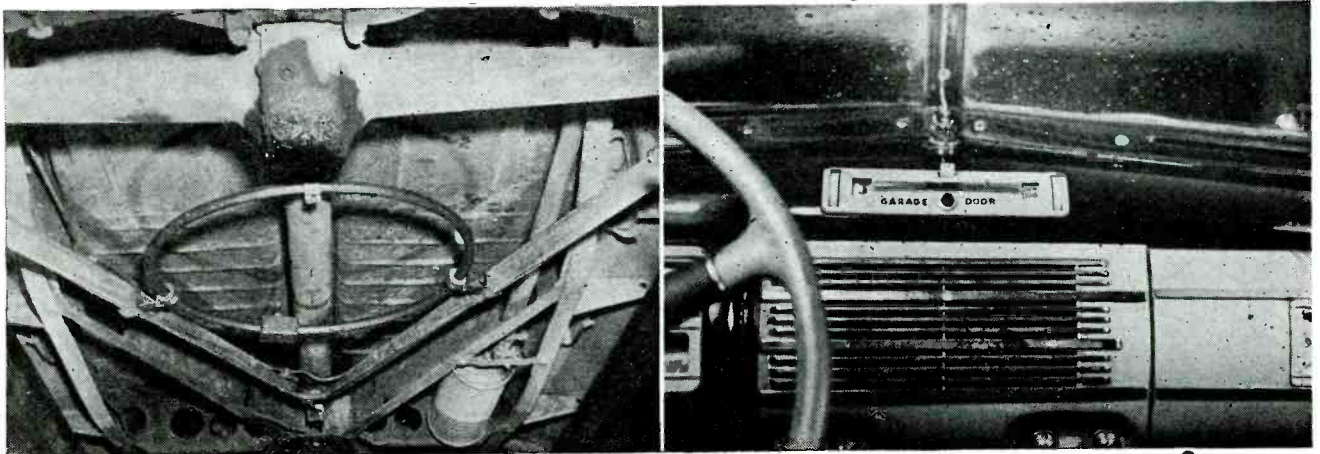

# PHASE SHIFT EFFECT

By **GOSWIN SCHAFFSTEIN**,  
Laboratories of the Opta Radio A.G.\*

• Knowledge of the phase shift,  $\phi$ , introduced during the passage of a signal through an amplifier as a function of angular velocity,  $\omega$ , is of importance in television apparatus and in any apparatus or instrument involving phase or frequency comparison or determination. It is intended to investigate the relation between the change in phase shift with angular velocity,  $d\phi/d\omega$ , and the circuit constants for tuned amplifiers.

$$\frac{d\phi}{d\omega} = \frac{-1}{1+A^2} \times \frac{Q}{\omega_c} \left(1 + \frac{\omega_c^2}{\omega^2}\right) \approx \frac{-1}{1+A^2} \times \frac{2Q}{\omega_c} \quad (2)$$

The second expression, an approximation, is valid in the neighborhood of the center frequency, where the ratio  $\omega_c^2/\omega^2$  deviates only by a negligible amount from unity. The second factor in this approximate expression is a constant for any particular circuit, while the first factor is a function of the operating frequency  $\omega/2\pi$ . The ratio of the amplification factor at resonance to the amplification factor off resonance  $V/V_0$  is equal to

$$\frac{V}{V_0} = \frac{1}{\sqrt{1+A^2}} \quad (3)$$

The curves in Fig. 2 illustrate the behavior of such a one-stage amplifier.

## Two stage amplifier

If the tuned amplifier contains  $n$  stages all resonant to the same frequency, the differential coefficient  $d\phi/d\omega$ , being an additive quantity, will be  $n$ -times that of a

\*Abstracted from the German (Hochfrequenztechnik und Elektroakustik, Berlin, July 1943) by J. Zentner, Ph.D., Associate Editor of Electronic Industries.

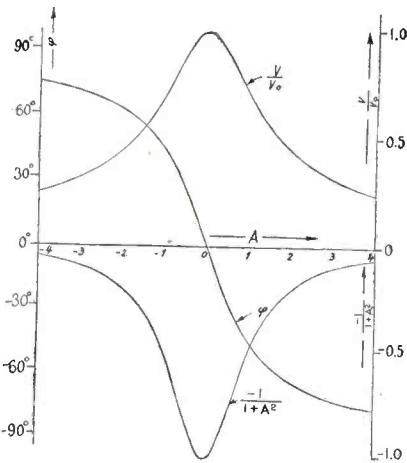
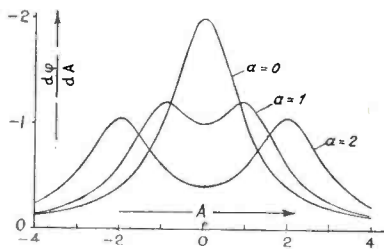

Fig. 2. Phase shift and relative amplification as function of center frequency for single stage amplifier as illustrated in above diagram



## One stage amplifier

Consider conditions in a one-stage, tuned amplifier using a pentode (see section enclosed by dotted line in Fig. 1.) The analysis is based on the generally valid relation

$$\phi = 180 - \tan^{-1} A, \quad \text{where } A = \left(\frac{\omega}{\omega_c} - \frac{\omega_c}{\omega}\right) Q, \quad (1)$$

$\omega_c/2\pi$  = center frequency,  $\omega/2\pi$  = operating frequency, and  $Q$  figure of merit of resonant circuit. By differentiation with respect to the angular velocity  $\omega$ , the equation

$$\frac{d\phi}{d\omega} = \frac{d\phi}{dA} \frac{Q}{\omega_c} \left(1 + \frac{\omega_c^2}{\omega^2}\right) \quad (1a)$$

follows. For a single tuned circuit

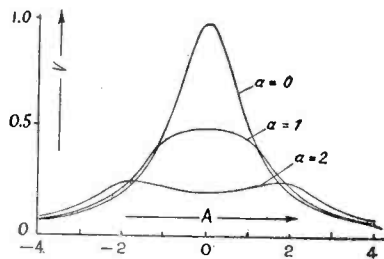

Figs. 3, 4, 5 and 6. Phase shift and relative amplification as function of center frequency measured in units of  $A$ ; the parameter  $\alpha$  indicates the detuning of the resonant circuits from the center frequency. The curves relate to two-stage resonant amplifiers or to single-stage transformer-coupled amplifiers

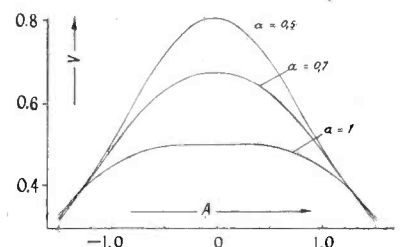
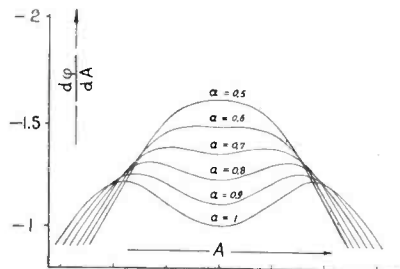
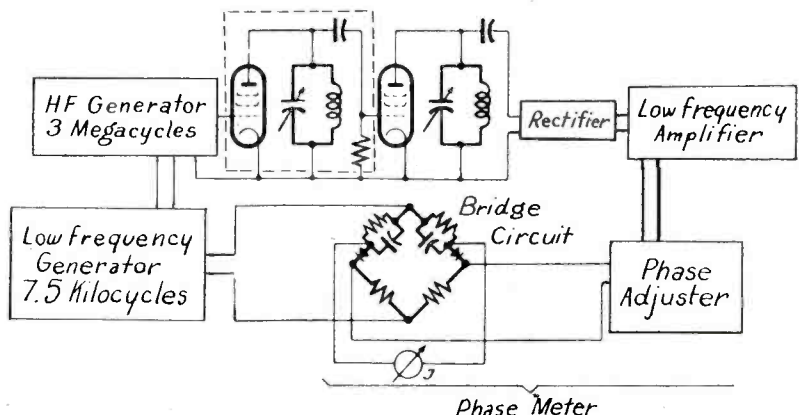

Fig. 1. Apparatus to show phase shift characteristics of high frequency amplifiers by modulating the hf carrier and measuring phase shift of modulating wave



# IN AMPLIFIERS

**Formulae and curves are presented for evaluation of phase shift as function of frequency in tuned amplifiers**

single stage. The relative amplification factor  $V/V_0$  of the complete amplifier, however, is the product of the amplification factors of the single stages. For tank circuits not resonant to the same frequency, the well known band pass filter effect with regard to amplification factor results. Consider the phase shift characteristic of such an amplifier containing two stages detuned by the amount,  $a$ , one above and the other below the center angular velocity  $\omega_c$ ;  $a$  is expressed in units of  $A$ , in other words:

$$a = \pm \left( \frac{\omega_r}{\omega_c} - \frac{\omega_c}{\omega_r} \right) Q \quad (4)$$

where  $\omega_r$  represents the angular velocities to which the circuits are tuned.  $Q$  is assumed equal for both circuits.

The computed curves for the two-stage amplifier are plotted in Figs. 3, 4, 5 and 6 with  $a$  as parameter. If  $d\phi/dA$  is known,  $d\phi/d\omega$  can be evaluated from equation (1a);  $\omega_c^2/\omega^2$  is assumed equal to unity. Such curves are well known to apply also to two identical, coupled circuits. A detuning by the amount  $a$  corresponds to a coupling factor of  $k/Q$ . It should be noted that the phase shift curves have two maxima for values at which the amplification curves have only one (see  $a=1$  curves corresponding to critical coupling).

### Test apparatus

A sinusoidally modulated high frequency wave was used to establish the phase shift introduced by the high frequency amplifier. The modulating frequency was 7.5 kc and the carrier or operating frequency  $\omega/2\pi$  was 3.0 mc. The circuit diagram in Fig. 1 showing the test apparatus is self-explanatory. For a  $90^\circ$  phase difference between the generated low frequency voltage and the low frequency voltage at the output of the phase adjuster the instrument in the phase bridge gives zero indication; the phase adjuster is manipulated until this condition obtains and the reading then indicates the phase shift  $\phi_m$  of the low frequency modulating wave introduced by its passage through the high frequency amplifier. Sensitivity is such that a phase change of 0.2 deg. could be detected.

The frequency shifts introduced in the low frequency amplifier, the phase adjuster and the phase bridge are constant throughout the experiments. However, because of these additional phase shifts the results obtained are not absolute values but relative phase shifts referred to the phase shift of the center frequency which is arbitrarily taken to be zero.

To evaluate the phase shift  $\phi_m$  expected for the low frequency wave, the relation

$$t = \frac{d\phi}{d\omega} = \frac{d\phi_m}{d\omega_m} \quad (5)$$

can be used; both fractions have the dimension of time and indicate the time delay  $t$  suffered by the low frequency and high frequency waves, respectively. These time delays may be equated, as the low frequency wave modulates the high frequency wave. From equation (1a) and (5), assuming  $\omega_c^2/\omega^2$  to be equal to unity:

$$\phi_m \cong \omega_m \frac{d\phi}{dA} \times \frac{2Q}{\omega_c} \quad (6)$$

### Experimental procedure

In the experiments the carrier frequency  $\omega$  was maintained constant while the tank circuit tuning

Figs. 9 and 10. Amplification and phase shift characteristics for flat amplification design;  $n$  is number of amplifier stages. It is seen that a considerable variation in phase shift over the operating frequency band results

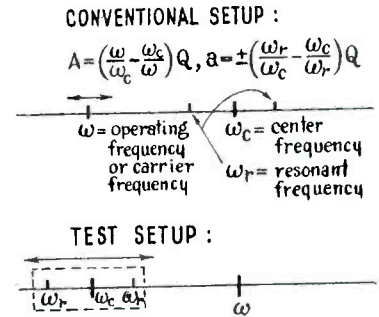
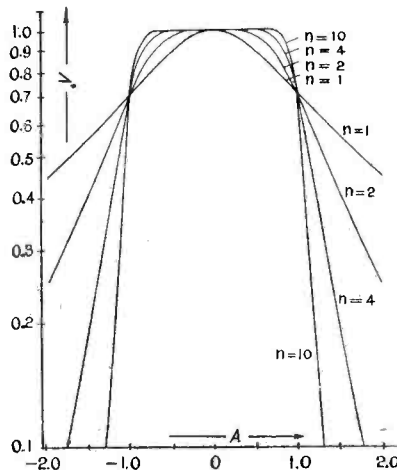

Fig. 7. Position of angular velocities in frequency spectrum for conventional amplifier operation compared to present test setup. The terminology in text refers to top sketch

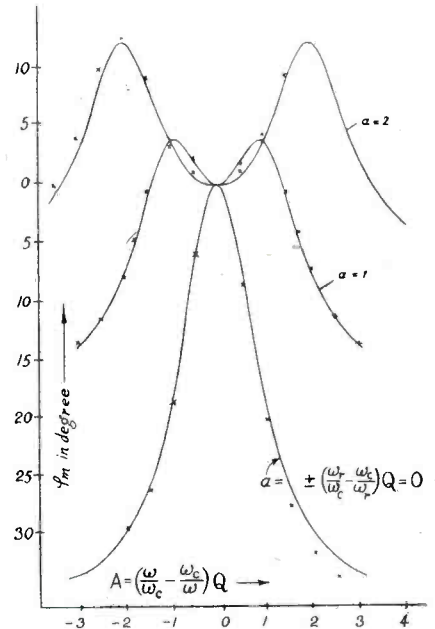
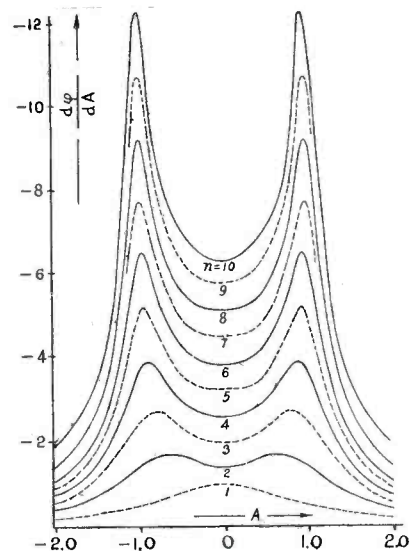
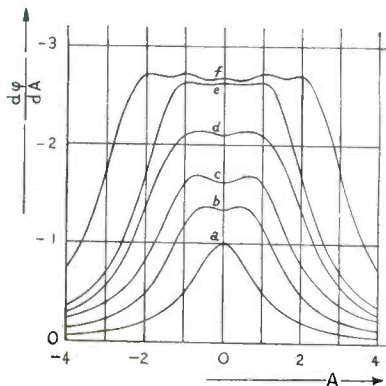

Fig. 8. Full line curves calculated values for phase shift are in good agreement with crosses obtained by measurements proving the method of computation proposed in the article





- a) one circuit;  $a = 0$ , all  $Q$ -values equal
- b) two circuits:  $a_1 = a_2 = 0.7$ , all  $Q$ -values equal
- c) three circuits:  $a_1 = a_2 = 0.9$ ,  $a_3 = 0$ ,  $Q_1 = Q_2 = 2Q_3$
- d) four circuits:  $a_1 = a_2 = 0.6$ ,  $a_3 = a_4 = 1.5$ , all  $Q$ -values equal
- e) five circuits:  $a_1 = 0$ ,  $a_2 = a_3 = 1$ ,  $a_4 = a_5 = 1.5$ , all  $Q$ -values equal

Figs. 11 and 12. Amplification and phase

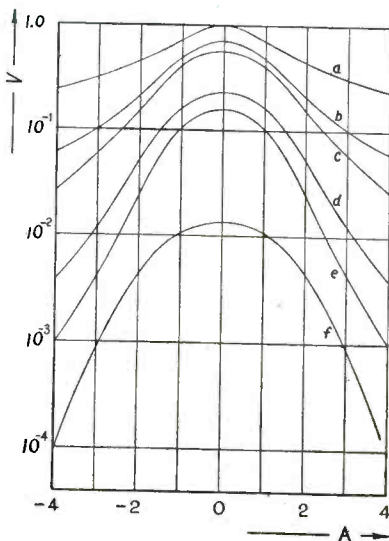

- f) seven circuits:  $a_1 = 0$ ,  $a_2 = a_3 = 1$ ,  $a_4 = a_5 = 2$ ,  $a_6 = a_7 = 2.5$ , all  $Q$ -values equal

of the high frequency amplifier was varied. The  $Q$  of both circuits was equal to 67. Sketch in Fig. 7 illustrates these conditions as compared to the more conventional variation of carrier frequency and constant center frequency. The curves obtained are of course identical with those that would have been obtained had the center frequency been kept constant and the carrier or operating frequency been varied. No notice need therefore be taken of the change in the further derivations and they may all be referred to the conventional set-up and terminology shown in the top sketch of the figure.

In Fig. 8 the phase shift  $\phi_m$  introduced into the low frequency wave is plotted against the value of  $A$ . Measured values are marked by crosses, the full lines corresponding to the computed curves;  $a$  defines the detuning of the two circuits be-

Figs. 13 and 14. Amplification and phase shift curves for three stage amplifiers comparing measured and computed values. Curves relate to amplifier designed for flat amplification characteristic, curves b to amplifier designed for flat phase shift as illustrated below

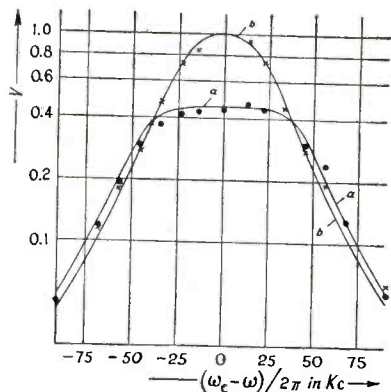

low and above the center frequency, respectively.

The curves in Fig. 8 were obtained as follows: Consider the curve for  $d\phi/dA$  in Fig. 3. For  $a = 0$  and  $A = 0$ ,  $d\phi/dA = -2$ ; consequently from equation (6),  $\phi_{m0} = -7.5 \times 10^3 \times 2 \times 67 \times 2/3 \times 10^6 = -0.666$  radians or  $-38.2$  deg. For  $a = -0$  and  $A = 1$ ,  $d\phi/dA = -1$ , and  $m_1 = 19.1$  deg. The change in phase shift or  $\phi_{m0} - \phi_{m1}$  is therefore  $-19.1$  deg. The curves in the Fig. 8 agree well with the measured values.

### Flat amplification

An amplifier having the closest possible flat amplification-frequency characteristic is designed to have a and  $Q$  values as follows:

$$Q = \frac{\omega_0}{\pi b \sqrt{2+k}}, \text{ and}$$

$$a = \frac{\omega_0}{\pi b \sqrt{2-k}} \quad (7)$$

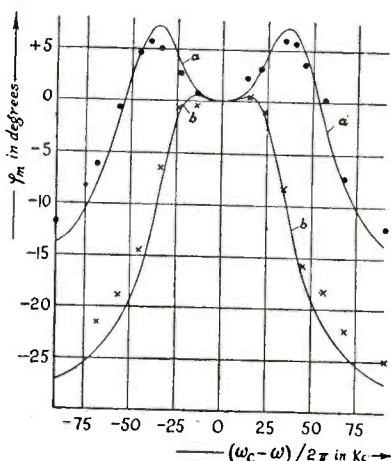

where  $b$  is the bandwidth (measured at .707 times the peak on the amplification curve). Values for  $k$  are listed in the accompanying table.

$n$	$k_0$	$k_1$	$k_2$	$k_3$	$k_4$	$k_5$
1	2	—	—	—	—	—
2	—	0	—	—	—	—
3	2	-1	—	—	—	—
4	—	-1.414	1.414	—	—	—
5	2	-1.618	0.618	—	—	—
6	—	-1.732	0	1.732	—	—
7	2	-1.802	-0.446	—	1.248	—
8	—	-1.848	-0.7654	0.7654	1.8484	—
9	2	-1.8794	-1.0	0.3474	1.832	—
10	—	-1.9021	-1.1756	0	1.1756	1.9021

For an even number of stages, two circuits having equal  $Q$  are detuned equal amounts a above and below the carrier frequency; for uneven numbers, one circuit is tuned to the carrier frequency while the others are treated as previously described. Fig. 9 shows the amplification-frequency characteristic of this type of amplifier for one, two, four and ten stages. The relative phase shifts are illustrated in Fig. 10. The abscissa  $A$  in this figure refers to a  $Q_0$  for which  $k = k_0 = 2$ . It will be seen that the phase shift varies considerably over the pass range of the amplifier.

In television transmission a value of  $1/6 \mu$  sec for the delay time  $t$  is considered admissible, assuming a 441 line picture. For a six stage amplifier, a carrier frequency of 20 mc and a maximum modulating frequency of 2 mc, the following conditions obtain:  $Q_0 = 20 \times 10^6 / 4 \times 10^6 = 5$  and the time delay  $t = d\phi/d\omega$

will be  $2 \frac{d\phi}{dA} \times 5/2\pi \times 20 \times 10^6$  ac-

ording to equation (1a). The value for  $d\phi/dA$  taken from Fig. 10 for 6 stages has a value of  $-3.85$  for  $A = 0$  and a value of  $-6.55$  for  $A = 0.9$ .  $t_1$  ( $A = 0$ ) and  $t_2$  ( $A = .9$ ) are then, according to the above formula, 0.30 and 0.52  $\mu$  sec, respectively; the difference is 0.22  $\mu$  sec, larger than the admissible limit of  $1/6 \mu$  sec.

### Flat phase shift

It is also possible to so dimension the amplifier components that the phase shift or the time delay are nearly independent of frequency. The detuning  $a$  of the circuits will then be smaller than in the first case, narrowing the band width of the amplifier. It should be noted that in Figs. 9 and 10 the abscissa is calibrated in units of  $A$  so that by a decrease in  $Q_0$  the band width in terms of actual frequency deviation may be kept constant.

Fig. 11 shows several examples for high frequency amplifiers designed for flat time delay characteristics; design data are noted on the

(Continued on page 138)

# Thru the LABORATORY KEYHOLE

## Current Research that Forecasts Future Electronic Developments

**NEW DIRECT-VIEW TELEVISION TUBE** may yet out-distance projection video, insists New Jersey group of devoted enthusiasts who are working on greatly improved tube that, for most home-set requirements, may eliminate need for reflectors and back-projection screens, with their light losses. Who knows?

**KILO MEGA MEGA CYCLES**—We hear rumors that much money and laboratory effort are being spent on the development of communications by means of ultra violet and infra red light. This reminds us of the time Doherty engineers transmitted the Moonlight Sonata over a moonbeam! Since we deal in frequencies in communications work, we will now have to think in terms of kilo mega mega cycles per second, as this "invisible light" has a wavelength of only .012 microns for short ultra violet to .04 cm for long infra red rays.

**IRONLESS LAB BUILDINGS** are being completed as part of a new \$15,000,000 Navy research project near Washington. There will be five of these non-ferrous structures used for testing of underwater magnetic mines, etc. Copper is being used for all nails, downspouts, radiators, heating pipes, plumbing, etc. All red bricks (iron oxide) and reinforced concrete are eliminated. Soil pipes are of asbestos and cement. Electric fixtures are of brass or plastic. A sixth building for the study of faint magnetic fields has no heating system, electric wires, telephone or any structures that would create even the feeblest magnetic force. Eggers & Higgins, New York, are the architects.

**PHILCO'S NEW FM TUBE**—Yarn going around concerns a new special FM tube being developed by Philco for its frequency-modulation sets postwar. Requests for information at headquarters elicited reply that no comment could be made at this time. So we still dunno!

**ELECTRONIC HOT DOGS**—Ever since Hero of Alexandria, who lived between 200 and 100 B.C. invented a slot machine for dispensing holy water at five drachmas a portion, robot salesmen have intrigued mechanical geniuses. In recent months famed Schenectady laboratories have been working on an electronic robot which cooks up a hot dog in 15 seconds, drops it into a toasted roll and delivers it to the customer. A dime in a slot does the trick, and the machine will even return the right change if needed.

**WELDING PLIOFILM FOR GANGRENE**—In treating certain flesh wounds which develop gangrene, one medical technic is to employ a glass chamber around the affected part which is then put under pressure. Thus glass boots were commonly used for treating frozen feet and legs where gangrene was possible or in effect. A wartime technic now being developed uses plastic material such as pliofilm, and other similar materials welded electronically by dielectric heating from high-frequency oscillators. These plastic boots are non-breakable, lighter in weight, and more easily formed around wounded parts.

**METAL FENCE AS SLAVE ANTENNA**—The unbending characteristics of electro-magnetic waves at frequencies from several hundred megacycles up, cause problems which sometimes are difficult to solve where it is desired to use their direct-line characteristics, but at the same time get them to go over a hill or otherwise around a corner. It is not always possible to locate ultra-high-frequency transmitters on the highest point in a given terrain. In order to get the ultra-high-frequency wave to go over the top of the earth, one development now under test utilizes a "fence" which acts as a collector of the transmitted energy and also reradiates it as desired.

**DRYING SPAGHETTI**—Food processors are taking more and more to the use of electronic heating methods for various purposes, but there is one problem that no one appears to know very much about. It has to do with the processing of spaghetti, macaroni and other similar glutinous pastes. The problem is reduce moisture content from about 35 per cent to approximately 10 per cent and to do it without causing the formation of a hard skin. Present non-electronic methods take a relatively long time. It is hoped that engineers may soon come up with a successful way to use electronically generated heat to quickly evaporate enough moisture to leave the proper texture for packaging. Know anything about it?

**NOTE:** Please don't ask us for more details about any of the foregoing. We present here all the information we have. As soon as we get more about any of these situations, full details will be printed in *Electronic Industries*. Our editors run across many interesting tips, leads, and rumors, both well-founded and baseless. We thought you would be interested in hearing about them, even if we can't give all the details or vouch for their authenticity. Editors.

---

## THE ATOMIC BOMB—THE BATTLE OF THE LABORATORIES

"The battle of the laboratories held fateful risks for us as well as the battles of the air, land and sea, and we have now won the battle of the laboratories as we have won the other battles.

"Beginning in 1940, before Pearl Harbor, scientific knowledge useful in war was pooled between the United States and Great Britain. Under that general policy the research on the atomic bomb was begun. With American and British scientists working together, we entered the race of discovery against the Germans.

"By 1942, however, we knew that the Germans were working feverishly to find a way to add atomic energy to the other engines of war with which they hoped to enslave the world. But they failed. We may be grateful to Providence that the Germans got the V-1's and the V-2's late and in limited quantities and even more grateful that they did not get the atomic bomb at all."—President H. S. Truman.

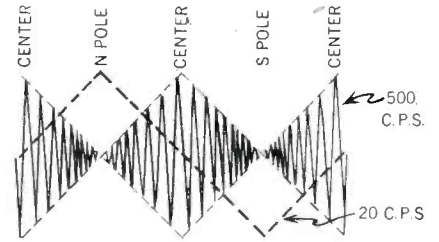
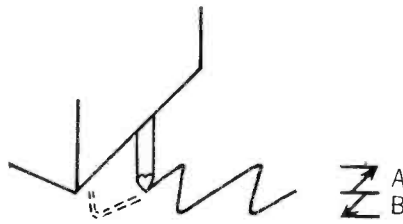
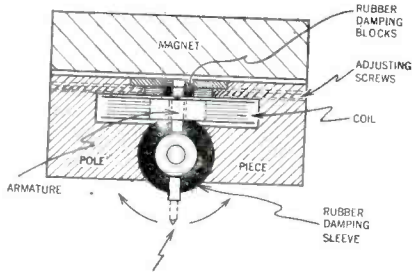

Fig. 1—Left. Typical magnetic reproducer-recorder. Construction with "single-ended" magnetic circuit. Fig. 2—Center. Motion in direction A equals that in B for sine wave. Fig. 4—Right. Motion of stylus due to 20 cps voltage, and the composite motion (within envelope) resulting from the addition of 500 cps voltage. The 500 cps vibration of the stylus is impeded by the damping as it approaches the poles

# PHONO HEAD BALANCE

By **NORMAN L. CHALFIN**,

Senior Application Engineer  
Crystal Division, North American Philips Co., Inc., Dobbs Ferry, N. Y.

## Dynamic adjustment of cutters and reproducers reduces the amount of distortion introduced in the system

● Magnetic reproducers and cutters for lateral groove recordings can be balanced accurately and quickly under operating conditions by means of a relatively simple dynamic adjustment method.

Fig. 1 shows a typical single-ended magnetic head for lateral groove cutting. If properly balanced and adjusted, when an audio frequency voltage is applied to the coil, the armature-stylus assembly will move with equal freedom to right or left of the center (or rest) position. If the unit is unbalanced electrically, mechanically or magnetically, or due to any combination of these three, non-uniform deflection of the stylus will result. Consequently the frequency cut on the record is distorted and is not an accurate representation of the applied signal.

Fig. 1 can also represent a magnetic reproducing head to which the same conditions of balance would apply. In this case the reproduced signal will be distorted as a

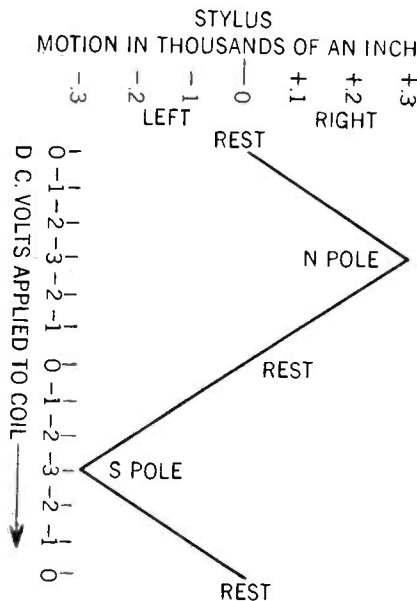

result of any unbalance in its operation. The distortions are produced in the playback coil as a result of voltages generated by the non-linear armature motion.

In setting up a mass production adjustment technique for the magnetic heads major considerations are rapidity, accuracy and a minimum personnel requirement. If possible the operation should be susceptible of performance by unskilled operators. The system herein described meets this requirement.

In use either as a recorder or as a reproducer, the stylus is driven in a sine wave motion by a sine wave applied signal or groove as is shown in Fig. 2. If, instead of either of these signals, motion is imparted to the stylus by a direct current applied to the coil of the unit, the stylus motion could be plotted as in Fig. 3. The direction is determined by the polarity of the voltage.

The amplitude of the movement

Fig. 3. Above. Stylus motion versus applied voltage. Fig. 5. Left. Circuit used to adjust head dynamically. The high and low frequency oscillators are connected in series and their mixed output actuates the head under test. Reflected voltage fluctuations due to the armature motion appear on the oscilloscope. Fig. 6. Right. Alternative method of observing motion of armature. This gives clearer picture

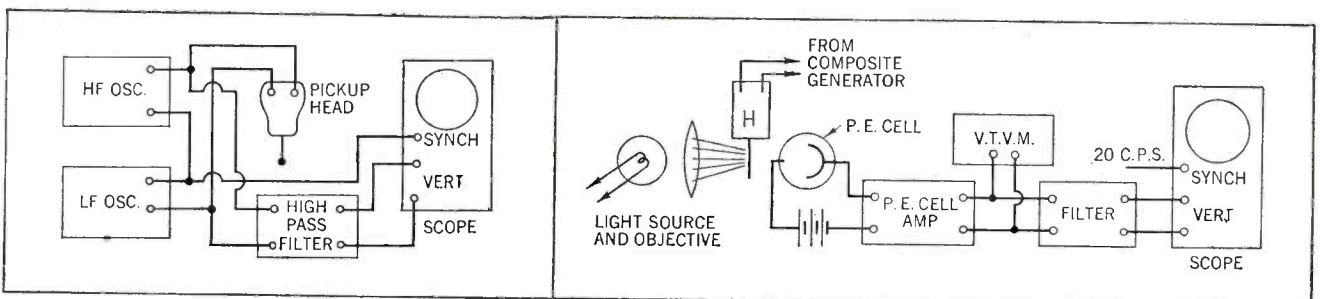



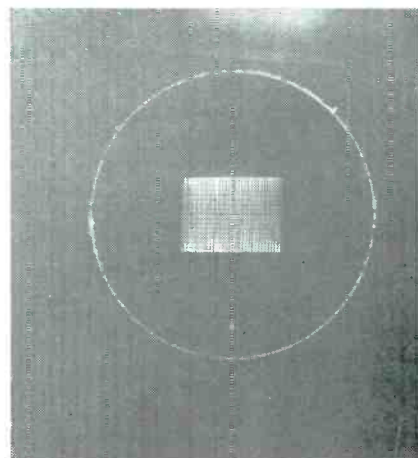
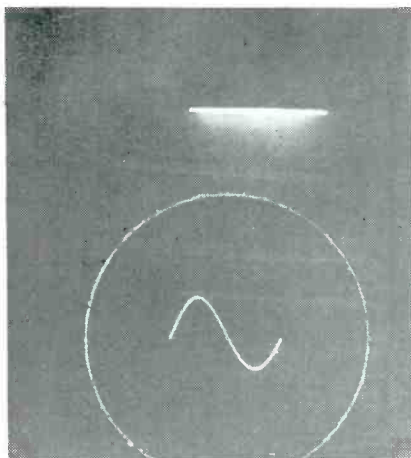
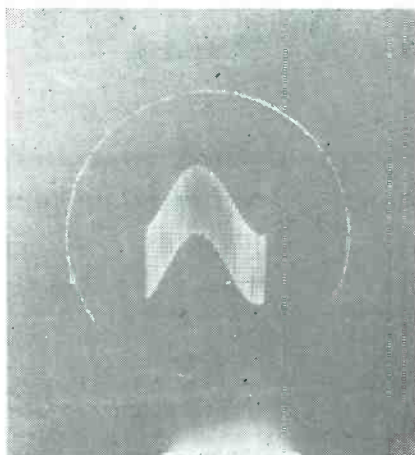
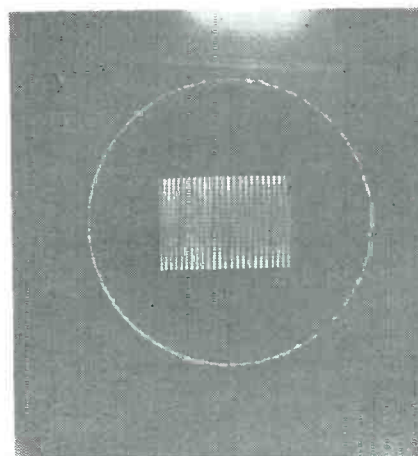
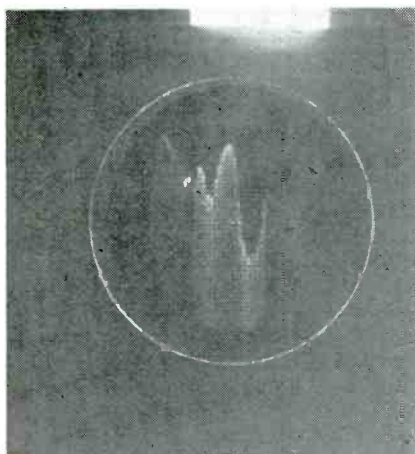

Fig. 7. Top left. Photo of pattern on oscillograph resulting from combined 20 cps and 500 cps audio voltages. B. Top center. Pattern of 20 cps sine wave alone. C. Top right. Pattern of 500 cps alone. D. Lower left. Pattern of unbalanced head. The two troughs correspond to adjacent amplitude minima in Fig. 4. Misadjustment of damping blocks causes variation. E. Lower right. Shows 20 cps filtered out of A



is a function of the voltage magnitude. This movement is of course limited by the dimensions of the magnetic gap and the armature will hit one of the pole pieces when this limitation is exceeded. The plot in Fig. 3 shows this motion, arbitrarily, within the limits of the gap when

dc voltages between  $-3$  and  $+3$  volts are applied. The movement is initiated from the rest position.

Consider the plot of Fig. 3 as a single cycle of some low frequency. Now, when there is simultaneously applied a high frequency signal, as the armature approaches either pole piece the high frequency amplitude will be reduced due to the increased stiffness of the armature caused by the rubber damping sleeve, while at the midpoint between the pole pieces the high frequency amplitude will be maximum. This will be the condition when properly balanced.

Fig. 4 is a representation of this composite motion resulting from the application of a low frequency upon which is superimposed a higher frequency. When all the elements are correctly balanced the upper half of the pattern of Fig. 4 can easily be observed on an oscillograph and a balanced condition will be indicated when two adjacent valleys corresponding to these under N-Pole and S-Pole in Fig. 4 are of equal depth. An unbalanced condition is illustrated in Fig. 7D.

To impart the desired motion to the armature-stylus assembly,

equipment is set up as shown in the block diagram of Fig. 5. Two audio oscillators are connected with their outputs in series. In this fashion mixing occurs to produce a signal as pictured in Fig. 7A. The oscillators used by the writer had

(Continued on page 138)

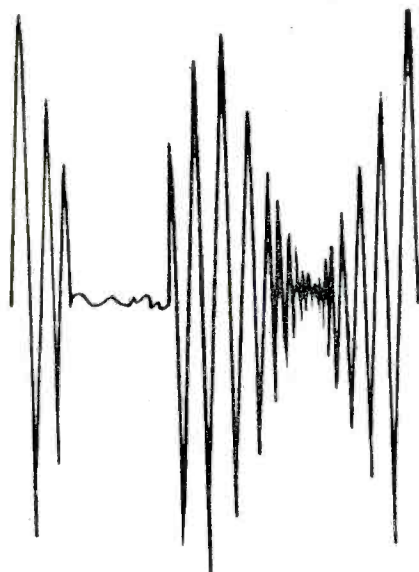
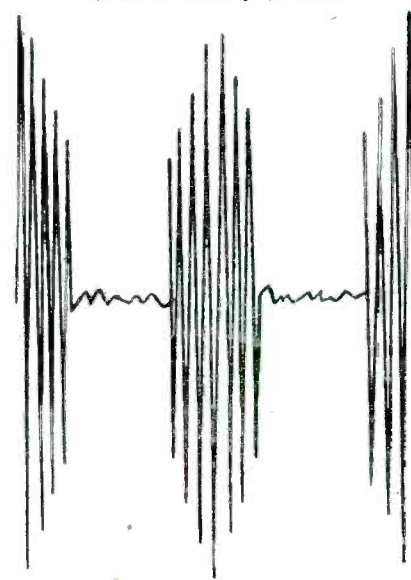
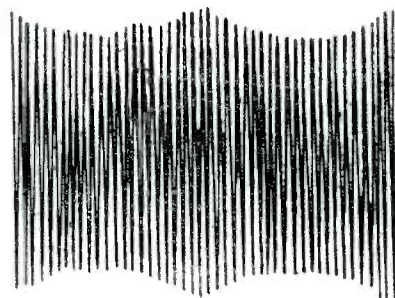

Fig. 8. A. Left. Drawing of 'scope pattern showing armature striking one pole piece with unbalance on one side. B. Right. Adjustment too loose. Armature strikes both poles. C. Below. Illustrates too tight adjustment



# GAGING BY THE BLIND

**Upper and lower limit switches introduce capacitors in audio oscillator circuit changing loud speaker tone**

• A new electronic sound gaging device, which may mean employment to thousands of America's

otherwise unemployable blind, is adaptable to precision gages with electrical or mechanical dial type

indicators and enables a blind operator to perform gaging work with the same accuracy as a sighted person. There is a small, cone-type speaker mounted on the back of the operator's chair and connected with the electronic device. The operator hears one of three different notes issuing from the loud-speaker. An article that is normal or within the size limit is indicated to the blind operator by the sound of the middle note. This means the article may be passed. The high note indicates the article is over-size, while the low note indicates that it is undersize. At the sound of either of these notes, the operator rejects the article under inspection.

The three notes are produced by an electronic oscillator which is controlled by relays connected to three indicator lights of the electronic gaging system. Red, green and orange indicator lights correspond to the three notes of the sound device, the red being high, the green low and the orange middle. Chief purpose of the indicator lights is to give the lineman (who sets up each gage) a quick visual check on the gage's efficiency. The gage is originally adjusted to a master gage and can be made to give both a visual and sound indication close enough for gaging fine roller bearing parts.

Engineers of the Timken Roller Bearing Co., who developed the sound gaging device made several models before the final one was found satisfactory. First gage to be developed was a "braille" gage. With this model, the article to be gaged was pushed between two points (representing the proper diameter of the article) in a horizontal plane electrically connected to a finger block. The contact of the article raised the first, second, or third of three points on a vertical plane. The first stood for a passable part, the second for one too small, the third for one too large. But this was considered too cumbersome for wide application.

The second gage to be developed in the evolutionary process was an electronic gage, suggested by an official whose flying experience had made him familiar with the "A" and "N" signals that guide pilots on their course. In this model, the

(Continued on page 142)

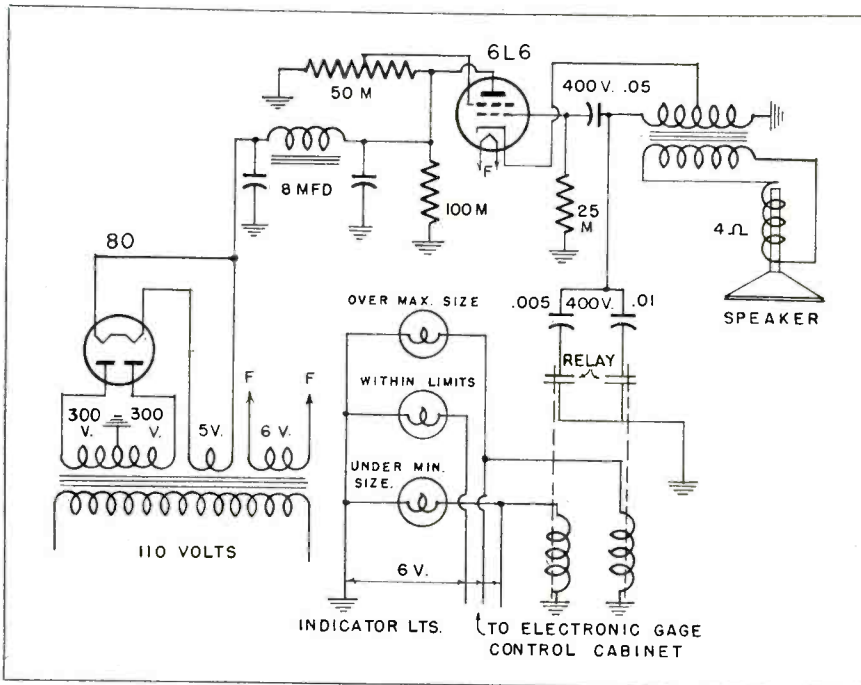

Above. Circuit diagram of electronic gage showing audio oscillator connected to loud speaker placed behind the blind operator's chair. Work to be gaged (as shown below) is pushed home against a micro switch which turns on the tone—high, medium or low as size varies

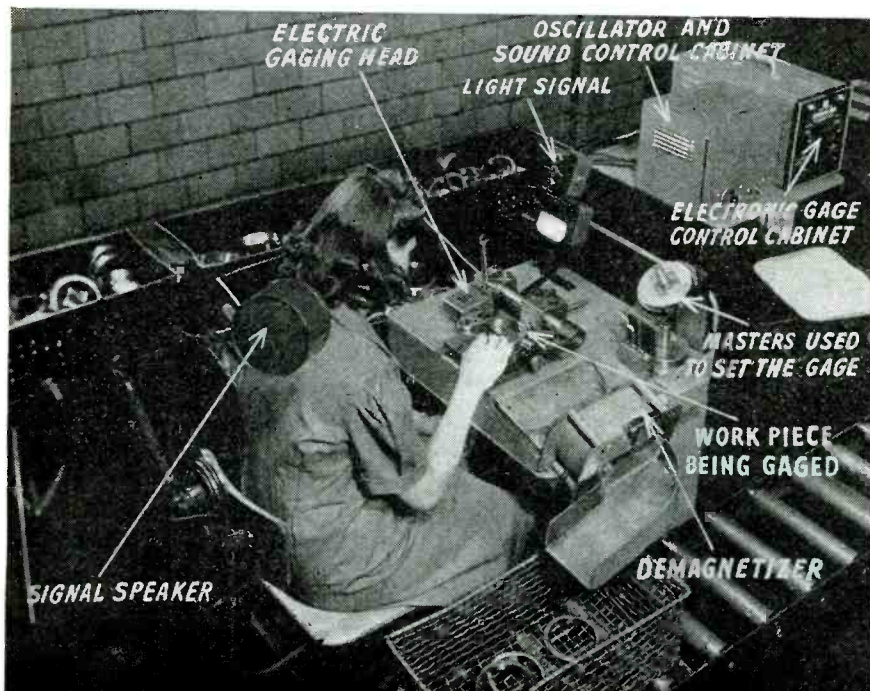

# \$1000 EDITORIAL AWARD

**Three Awards to be made by ELECTRONIC INDUSTRIES for engineering articles of outstanding value in advancing electronic principles**

● ELECTRONIC INDUSTRIES, published by Caldwell-Clements, Inc., in May announced Special Editorial Awards totaling \$1,000 to be presented for outstanding articles or papers contributed for publication and conforming with editorial policies, dealing with timely subjects intimately related with the practical application of electronic principles.

The awards will go to the author, or authors, of those manuscripts, published in this magazine during the remainder of 1945, judged to be the best, taking into consideration originality of thought and the practical value of the particular application in advancing electronic engineering precepts.

The awards are three in number: A First Award of \$600; a Second Award of \$300, and a Third Award of \$100. The simple conditions under which the Awards are to be made are given in an adjacent column.

The purpose of the Awards is to encourage the publication of original thinking, planning and achievement which may be of practical value. It is the belief of the Editors that there is a vast storehouse of engineering information locked up in the accomplishments of many engineers and that the publication of such material will be of immense value to a very large percentage of engineers who are directly responsible in shaping the destinies of their companies.

## **Object of awards**

A principal object in making the Awards is to draw out such material so that it may be readily available; to put it on paper where it may do the greatest good to the greatest number; to stimulate engineering thinking; to help in the solution of engineering problems that must be solved in order that the already great and rapidly growing electronic industry may continue the upward curve of its successes.

Obviously there is a certain amount of engineering information that is buried under the veil of military secrecy and that for security reasons cannot emerge until

after the war shall have been won. Such material may well have a profound effect on postwar developments and it is hoped that at least some of such information may be made available in time for consideration under the terms of the Award.

## **Type of articles**

ELECTRONIC INDUSTRIES accordingly opens its pages to any and all engineers who have a story of real accomplishment to tell. The Awards will not be made on the basis of past reputation. The contest is not confined to any one class of engineers, but is open to all. The engineer of some small, almost unheard of company has exactly the same chance of winning an Award on the basis of originality of thinking and practical application as has the biggest engineer of the biggest company. Nor has the contest any geographical limitations. Manu-

scripts will be welcome, regardless of their source. The only proviso is the manuscripts must be printable in so far as the Armed Forces are concerned and must be properly cleared by the author's employers.

Manuscripts intended for consideration under the terms of the Awards must, in the judgment of the Editors, be suitable for publication in ELECTRONIC INDUSTRIES. If suitable for publication in ELECTRONIC INDUSTRIES they will be published and payment will be made for such manuscripts at the time of publication. They will, in addition, be considered for one of the Special Awards.

One thing more—to be eligible for consideration under the terms of the Awards, a manuscript must have been published in ELECTRONIC INDUSTRIES during the period between and including May, 1945, and December, 1945.

## **AWARD CONDITIONS**

- 1—Manuscripts should be primarily engineering in nature and may include only original material not previously presented or published and must be of a nature suitable for publication in ELECTRONIC INDUSTRIES.
- 2—All manuscripts are to become the exclusive property of ELECTRONIC INDUSTRIES and may not be reproduced elsewhere in whole or in part.
- 3—All manuscripts must have Army, Navy and other clearance, as required, permitting publication.
- 4—Manuscripts may deal with any electronic engineering, research or scientific subject.
- 5—Manuscripts should be illustrated with photographs, diagrams, etc., as may be needed to supplement the text.
- 6—All manuscripts deemed suitable for publication in ELECTRONIC INDUSTRIES will be published and paid for at regular rates and will receive the consideration of the judges as to their suitability for one of the Awards.
- 7—The Award period shall start with the May issue of ELECTRONIC INDUSTRIES (closing date April 1, 1945) and conclude with the December issue (closing date November 1, 1945) and only manuscripts published during that period will be considered in making the Awards.
- 8—The Judges will be a Panel of engineers recognized in their respective fields and their judgment will be final.
- 9—In the case of more than one author collaborating in the preparation of a manuscript, any Award will be equally divided among the authors.
- 10—The basis of the Awards shall be originality of thought and the practical value of the manuscript in advancing the electronic arts.
- 11—The contest is open to all contributors except employees of Caldwell-Clements, Inc., their families or relatives.

# TUBES ON THE JOB

## Quartz Cutting Jig

A new jig has been developed, reports F. Davis of North American Philips Co., Inc., Dobbs Ferry, N. Y., that greatly simplifies the mounting procedure of quartz rock preparatory to its wafering into slabs.

Many rocks can be mounted directly on a natural cap face which makes an angle with Z of 38 deg. 15 by the usual means. The opposite face or natural prism side associated with the cap face is aligned vertically to the saw bed with a square. This positions the rack so the Z axis is parallel to the saw bed and at 38 deg. 15 with reference to the saw blade. The saw bed may then be turned to the right or left depending on the angle of cut with the Z axis.

Rocks having no cap face but a natural side are placed in the jig on the side, with the X direction approximately parallel with the lip of the jig. The clamping surface of the jig is pitched with relationship to the base and may be adjustable between 20 deg. and 60 deg. It also is adjustable through 360 deg. in a horizontal direction. The rock is so placed in the clamp that the side presented to the X-ray beam is major or minor depending on the type of cut desired.

The whole jig is then placed on a reference plate in the X-ray machine. The X-ray machine is set up on a reflecting plane that makes an angle with Z of 38 deg. 15. The plate on which the rock is mounted is moved horizontally and vertically until the greatest deflection of the ammeter is noted and tightened in



Quartz cutting jig ready for positioning on the movable table beneath the cutting saw

this position. The jig is then placed on a reference plate on the saw bed which is keyed with the setting of the X-ray machine. A surface is cut which is used for mounting the rock on the dop. The surface so produced will be accurately aligned in the X axis direction and will be within 3 deg. or 4 deg. of 38 deg. 15 in the Z direction.

The jig can also be used for irregular or unfaced rocks providing a surface is first cut at right angles to the Z axis of the rock. The rock is then clamped on this surface in the jig.

## Tympanometer Head

In high-altitude flying a definite relationship has been found between the ease or difficulty of compensation by the flier for changes in altitude and his ability as an air fighter. This altitude accommodation is made by swallowing, which equalizes the pressure on both sides of the ear drum or tympanum.

Heretofore, physicians have had to enter a high-altitude chamber with the prospective flier and count the swallows, and relate them to the rate of change of pressure, i.e., altitude. To make the examination more accurate and obviate the necessity of the physician remaining in the high-altitude chamber during the test, instruments that appear to be oversize earphones with "horns" have been developed at the Westinghouse Research Laboratories. Clamped on the head of the flier, an earpiece over each ear, the swallows are automatically transmitted by the instruments and recorded on a chart outside the chamber.

Against each ear of the subject are placed fluid-filled chambers. The fluid rests against the ear drum on one side, and on the other against a diaphragm in the "earphone." The "earphone" is a micro-wave transmitter—the "horn" its antenna. The diaphragm, coupled by the liquid to the eardrum, with each swallow moves a pin within the instrument, and this movement of the pin causes an amplitude change in the transmitted wave. Thus, the record of a com-

Into each over-sized earphone of the Tympanometer are compressed the essentials of a micro-wave transmitter with complete means of varying the output wave in response to both voluntary and involuntary accommodations to varying atmospheric pressures as indicated by movements of the tympanum (ear drum)

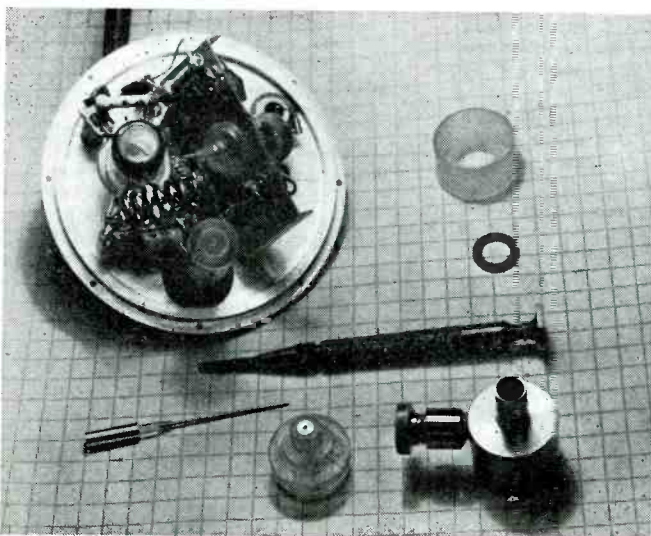

pensation appears as a "peak" in an otherwise smooth graph.

The problem of transmitting the impulses to the recorder outside the high-altitude chamber is essentially one of a telemetering. Because the chamber is a metal enclosure, the receiving antenna is mounted inside, and is connected through a coaxial cable. Accurately plotted graphs of swallows versus altitude (or pressure) are made without the doctor being required to undergo the discomfort of the high-altitude cycle.

### **Pulsed-Energy Fish Screens**

Millions of fish are still swimming the nation's streams today because of electronic screens that provide an invisible "safety zone" and bar the fish from destroying themselves in the water intakes of irrigation projects, hydroelectric plants, and industrial works.

The screens consist of rows of metal pipes, or electrodes that swing freely from an overhead support above the stream. Water and debris pass through easily, but as the fish approach the "fence" they receive a series of mild and harmless shocks that send them scurrying safely away.

The impulses are produced at the rate of from four to eight a second in an electronic generator developed jointly by engineers of the Electric Fish Screen Company and Westinghouse. A special wave form of electric current, the result of several years of research and experiment, turns back both large and small fish simultaneously, a feat impossible with ordinary current.

The electronic screens are used not only to keep fish away from water intakes, but also to fence them in at hatcheries. At Pymatuning Dam in northwestern Pennsylvania, for example, the screens "ride herd" on the fish, preventing them from migrating upstream where they would be caught by fishermen or eaten by larger fish.

### **Radar for Ships**

Calling radar the greatest single aid a ship could have, Commodore George J. Barendse, retired skipper of the Holland-America liner Nieuw Amsterdam, predicted that its use on merchant ships in the postwar era will completely eliminate navigational problems such as delays in fog and risk of collision in darkness, reports Arthur H. Richter in the N. Y. Times.

The commodore believes that radar installation should be made compulsory for all steamship companies after the war. He said the ability to penetrate dense fogs or severe storms with complete safety would keep merchant shipping on,

or very close to schedule. Savings realized by such schedules would more than make up the installation costs, he asserted.

As an example of its application, Commodore Barendse told of completing the last two days of a wartime journey here in a dense fog, traveling strictly on radar with no use of visible aids without even wandering a single point off course or coming anywhere near other ships, harbor craft or danger zones.

### **Electric-Eye Protection**

The boring tool won't move in to finish bore the blank for a high precision gear mounted on a Simplex Borematic at Michigan Tool Co., Detroit, as long as the aligning plug is in position or even while the operator is removing the plug. The

PE cell protection prevents boring mill being started until after removal of aligning plug



Part of the elaborate testing equipment with which static accuracy tests are made of inputs of range, elevation, azimuth, gun position, altitude, air speed and air temperature to the General Electric computer with which turrets on the Army's B-29 Superfortress airplanes are controlled

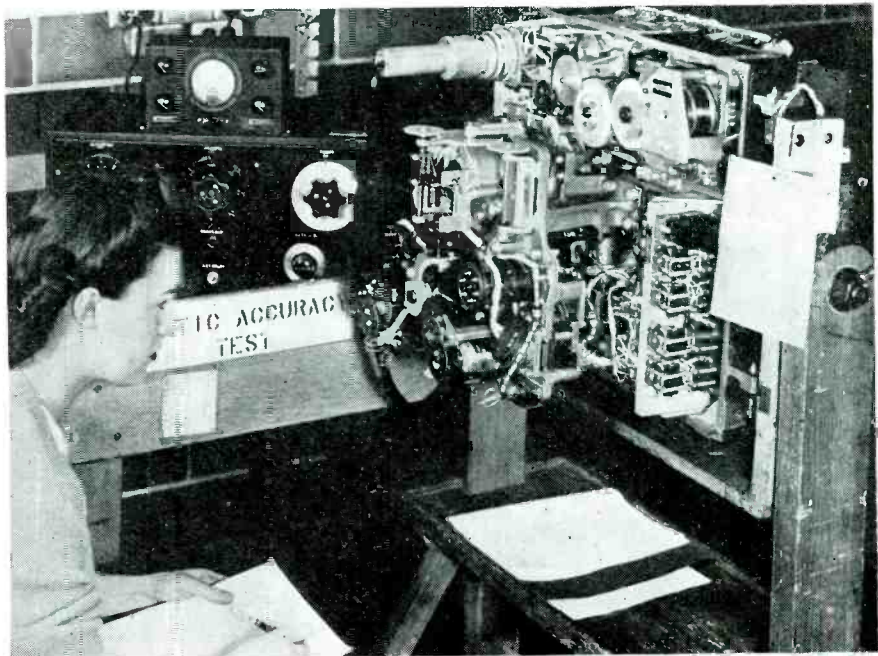

light beam to the photo-electric cell is interrupted by this plug, the circuit being so arranged that the machine cannot be started until the work area is clear. The arrangement prevents possible injury to both hands and equipment through accidental starting of the machine.

### **Voice-Written Records for Industry**

"Take or give no orders that are not in writing" has been the rule of industry for years, as a verbal order leaves no record. The long playing recorder, on film and wire, is voiding this requirement in many industrial services since it eliminates the tedious writing of messages just for the record.

### **Brain Test**

The intricate and highly precise "brain in the box" that is the General Electric computer for the B-29 undergoes a thorough "mental" exam upon completion. In the static accuracy test shown here, inputs of range, elevation and azimuth gun position, altitude, airspeed, and air temperature are introduced into the computer. Outputs consisting of elevation and azimuth correction angles are checked against calculated output data. Installed on a B-29, the computer automatically calculates the parallax, windage, gravity drop, and lead corrections and adds them into a total correction. Result is that the turrets are pointed so that bullets and target arrive at the same point at the same time.

## Capacitance Gas Gage

Two concentric tubes placed vertically inside the gasoline tanks in large bombers form the two plates of a capacitor. As gasoline rises in the tubes capacity changes because the dielectric constant of gasoline is different from that of air. This difference in capacitance is utilized in an electronic circuit to record the amount of gasoline remaining in the tanks. At the request of the Air Technical Service Command, Wright Field, this immersion condenser principle has been applied by Minneapolis Honeywell Regulator Co. so successfully that an accuracy within 5 per cent is claimed under extreme conditions of temperature, altitude and plane attitude. This accuracy, which compares with about 15 per cent for the older mechanical float type, has reduced the factor of safety requirements in long distance opera-

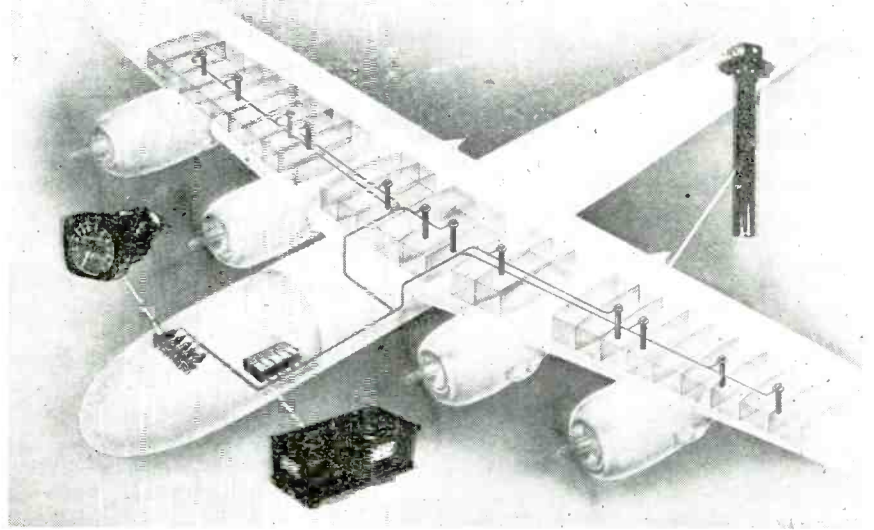

Schematic showing the location of capacitor type gasoline gages in Superfortress tanks and the manner in which they are connected to give accurate continuous indication of fuel supply

tion to the extent that much additional bomb load can be carried.

## Radiotelephone Pipe Line

Because field personnel must exercise constant vigilance for failures and breakdowns in the operation of a pipe line, the Union Gas Systems of Independence, Kan., has installed a 250-watt Motorola-Galvin FM (30-44 mc) transmitter-receiver at its headquarters and 14 Motorola-Galvin, 30-watt mobile units in maintenance cars and trucks. Twenty more mobile Motorola installations are being planned.

A 250-foot tower supports the main station antenna, and signals from it can be read with ease in Burlington, Kan., over 60 airline miles away. This is the farthest point of the pipe line, and thus the entire system is in communication directly with the main office at all times.

A unique feature is that the main station is controlled from four different consoles, parallel-connected, at one time. One remote console is located at the telephone switchboard for immediate transference of information from the land line to radiotelephone for action by the crews. Another remote console is in the office of the president of the firm, for close contact with field personnel throughout the system by top management. The remaining two remote positions are respectively at the base of the tower and in the gas measurement department where the superintendent keeps contact with emergency conditions.

## Remote Recorder

The radio registering system developed by Leupold & Stevens Instruments, Portland, Oregon, is widely used to provide registration of water levels, rainfall, etc., at locations which are not easily acces-

## MICROSECOND X-RAY CAMERA POWER HOUSE

This is a view of the energy factory required for millionth-of-a-second x-ray exposure. The tube which makes such pictures possible, shown at the Westinghouse Lamp Division, Bloomfield, N. J., where it was developed, is mounted at the front of the power source, styled a surge generator. To attain the enormous sudden burst of 600 million watts of electricity to make these short exposures, energy is stored in a bank of six capacitors, is push-button controlled

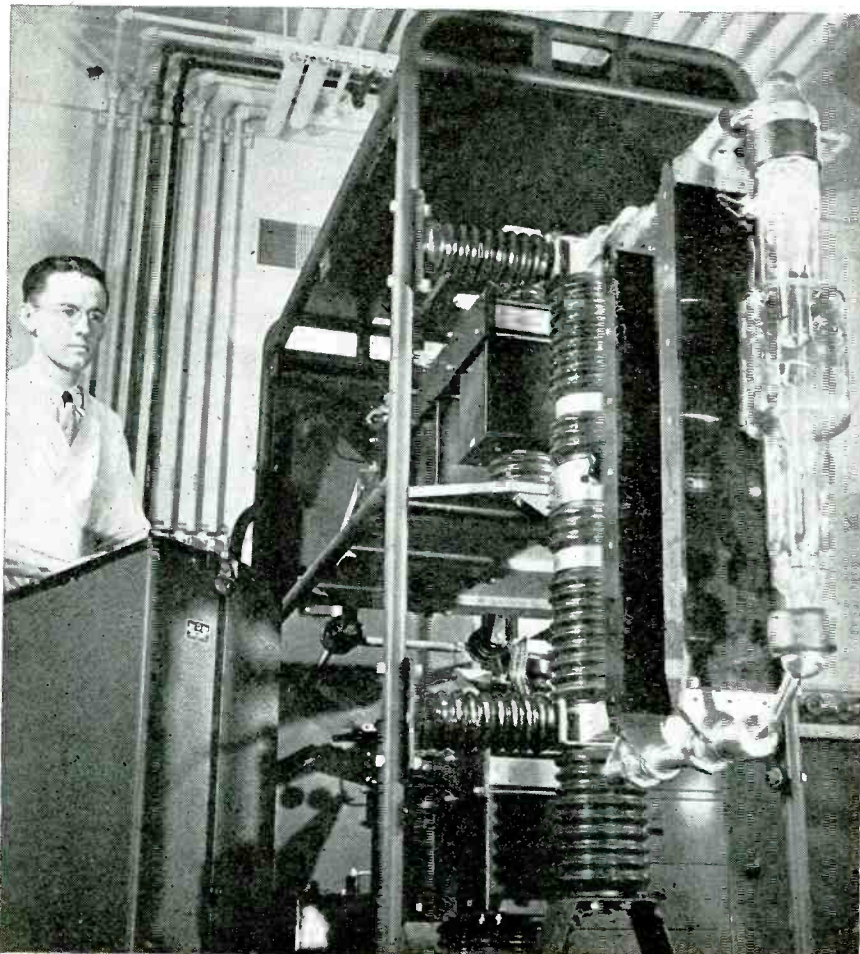

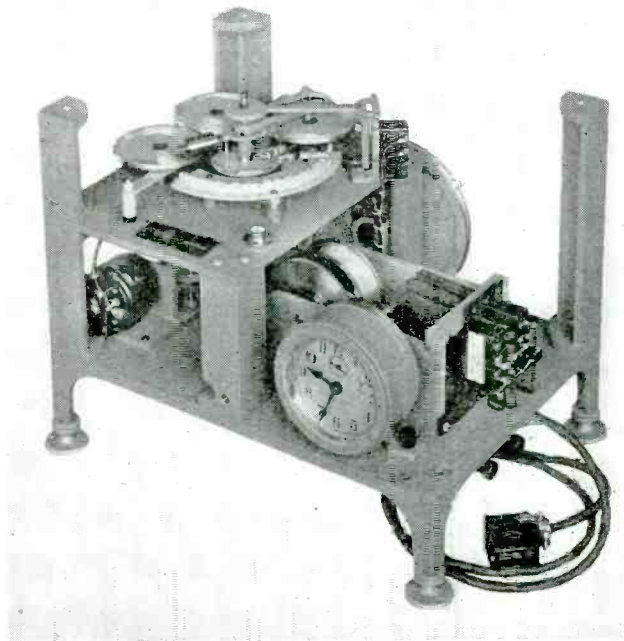
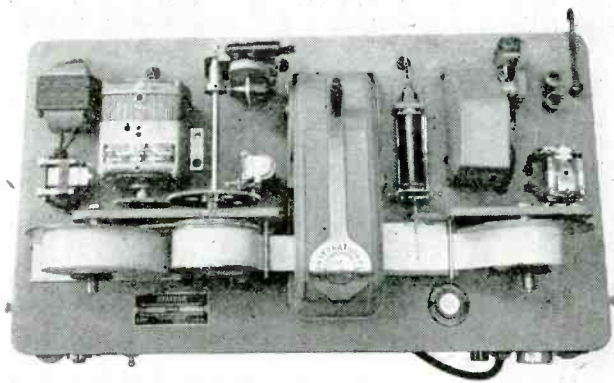

Two views of the equipment used in the recording by remote control of water level, rainfall, etc. Left, the radio recorder mechanism; right, the Stevens Telemark apparatus

sible. The system comprises a Stevens Telemark and time switch associated with a radio transmitter at the measuring station, and a radio receiver and recorder at the point of reception.

The Telemark is the coding device for keying the transmitter's modulated carrier. It is operated by a float which positions the code selecting disks in such a manner that a coded signal representing the water level is keyed when the ridged disks are traversed by a rotating arm. The preset time switch turns on the transmitter, starts rotation of the arm, and turns off the transmitter after completion of two or more cycles of operation. This operation also includes the call-letters of the transmitter.

The transmitted signal is received by a pretuned superheterodyne which is periodically turned on and off by a Telechron motor synchronized with the time switch. The received signals are relayed to a registering pen which records them on a strip chart actuated by the first of the received signals. Alongside of each set of signals is automatically stamped the date, hour and minute of reception.

The transmitter and receiver are designed to operate at a frequency in the neighborhood of 3 mc. Records from a number of stations scattered over a large area are obtained through a radio relay station with a receiver responding to signals from each of the Telemark sites, when short wave transmitters are used.

### 50 kw Tube Tester

When type ML-893 tubes are produced at the Machlett Laboratories, Norwalk, Conn., they must undergo an operation test to prove ability to deliver 50 kw, about the same as a large broadcasting station. To make this test, for which 100 kwh

energy is needed, a new test oscillator was recently installed. It simulates operating conditions as closely as possible.

Newly installed test oscillator, built to produce 100 kw of power and to simulate actual operating conditions, with which 50 kw tubes built by Machlett Laboratories, Norwalk, are tested

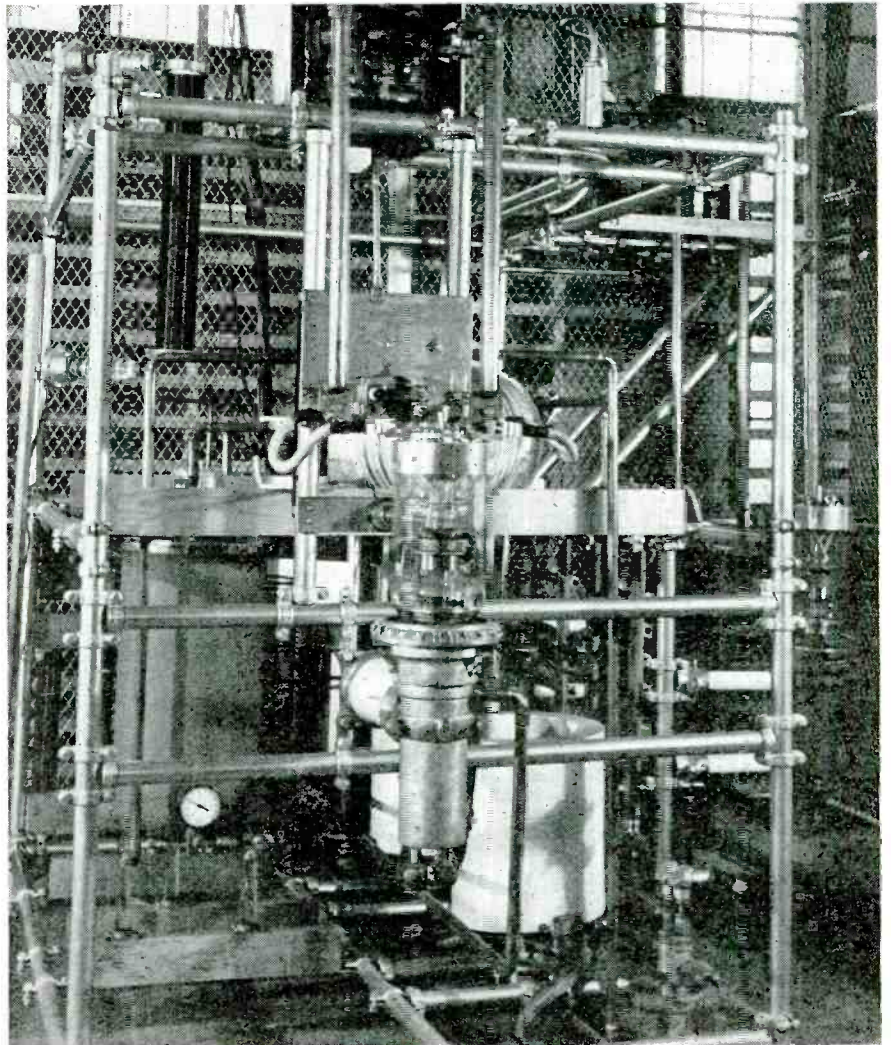

# SURVEY of WIDE READING

Electronic news in the world's press. Review of engineering, scientific and industrial journals, here and abroad

## Performance of RC-Coupled Push-Pull Oscillators

W. F. Lowering (Philosophical Magazine, London, November, 1944).

The RC-coupled push-pull oscillator illustrated in Fig. 1 will oscillate at the frequency for which the voltage  $E_o$  between C and D is in phase with the voltage  $E_i$  between A and B. This will occur at the frequency  $f_o$  for which  $(2\pi f_o)^2 = 1/C_1 C_2 R_5 R_6$ . Any tendency for the oscillation frequency to change is offset by the resulting phase shift between  $E_o$  and  $E_i$ . The greater the

change  $\frac{d\phi}{df}$  in the phase angle  $\phi$

between  $E_o$  and  $E_i$  with frequency, therefore, the better the frequency stability. The smaller the attenuation in the feed-back at the oscillation frequency  $f_o$  the better, since less amplification is required and therefore more negative feed-back may be employed.

### Filter

Based on these considerations equivalent networks of several RC-feedback phase-shift networks are studied; the particular form shown in Fig. 1 proved the best choice. It

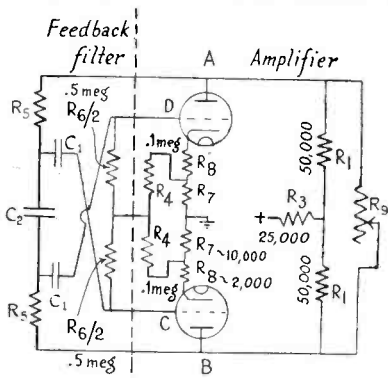

Fig. 1. Diagram of preferred form of push-pull oscillator chosen for its frequency stability and good sine wave form of output

is derived that the phase shift with frequency  $\frac{d\phi}{df}$  at the oscillation

frequency  $f_o$  has a maximum possible value of  $-1/2\pi f_o$  when  $R_6 C_1$  is equal to  $4R_5 C_2$  and if the value of  $R_6$  is much greater than twice that of  $R_5$ .

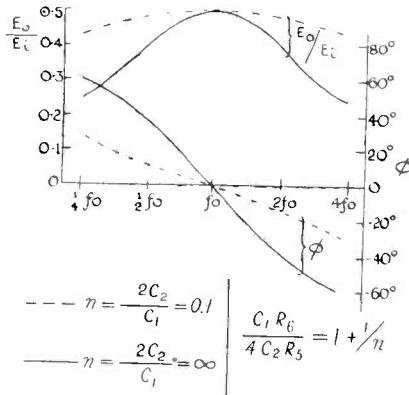

Fig. 2. Curves illustrate performance of circuit in Fig. 1. Phase shift and amplification factor are plotted as function of frequency

If the oscillation frequency is to be varied, it will be necessary to gang either the capacitors or the resistors to maintain  $E_o/E_i$  constant. In this instance convenient values for the ratio  $2C_2/C_1$  will be  $1/2$ , 1 or 2, the choice of this value not being critical.

The performance of this circuit with a change in frequency is illustrated in Fig. 2 for  $C_1 R_6 / 4 C_2 R_5 = (1 + 1/n)$  and the parameter  $n = 2C_2/C_1$  equal to 0.1 for the dashed curve and equal to infinity for the solid curve.

### Amplifier

The requirements of the amplifier section of Fig. 1 are studied for various conditions. It is shown that if a tube with a high amplification factor is used, and load and cathode resistors are made large, the stage gain becomes almost independent of the tube characteristics and of the supply voltages; it is equal to the ratio of the load resistor to the cathode resistor.

If the input impedance of the filter is not very much greater than the load resistor, the oscillation frequency will be lowered. The effect of plate-grid capacity is also to lower the oscillation frequency; further, it necessitates increased amplification. The use of pentodes is recommended.

### Experiments

Purity of waveform, frequency stability, influence of supply volt-

ages and frequency limits were investigated by experiments mostly with the circuit shown. In this circuit, the resistances  $R_8$  were used to provide the correct value of steady grid bias, as the total cathode resistances had been chosen to give the required ac negative feedback and were greater than was desirable for the bias resistances.

Several oscillators were tested: Oscillator No. 1: Tube type M.H.4;  $C_1 = 125\mu\mu F$ ;  $C_2 = 1100\mu\mu F$ ;  $R_5 = 100,000$  ohms approximately;  $R_6 = 250,000$  ohms approximately. The resistances  $R_5$  and  $R_6$  were adjusted so that with a mains voltage of 210 volts the oscillator gave a good sine-wave output at 500 cycles.

Upon exclusion of frequency drift due to initial heating effects, the frequency remained constant within 0.2 cycles; from observations it appeared probable that these variations were due to changes in mains frequency. A change of mains voltage from 210 volts to 100 volts resulted in a 1 cycle fall in frequency.

Oscillator No. 2: Tube types M.H.L.4;  $R_6 = 450,000$  ohms approximately; other values as in oscillator 1; frequency 500 cycles.

This oscillator was practically as stable as oscillator No. 1, in spite of the lower amplification factor of the tubes.

Oscillator No. 3: Tube types M.H.4;  $R_5 = 73,000$  ohms approximately,  $C_2 = 200\mu\mu F$ ,  $C_1 = .01\mu\mu F$ ,  $R_6 = 300,000$  ohms;  $R_8 = 84,000$  ohms approximately; frequency 500 cycles.

This circuit was used to investigate the effect of using a feedback network with component values far from the optimum. It was rather more critical in adjustment than Nos. 1 and 2, and the output voltage was very dependent upon the mains voltage, oscillation ceasing when the mains voltage was reduced to 140 volts. Otherwise the performance was similar to that of the other oscillators.

Oscillator No. 4: Tube types M.H.4;  $R_1 = 0.25$  megohms;  $R_3 = 25,000$  ohms;  $R_7 = 100,000$  ohms;  $R_4 = 100,000$  ohms;  $R_8 = 6,000$  ohms;  $R_6 =$  megohm;  $C_1 = 200\mu\mu F$ ,  $C_2 = 500\mu\mu F$ ;  $R_5 = 38,000$  ohms approximately; frequency = 750 cycles.

With these entirely different circuit values the frequency stability



was quite as good, the drift being less than 0.3 cycles. A change of mains voltage from 210 volts to 100 volts caused a fall of frequency of 2 cycles.

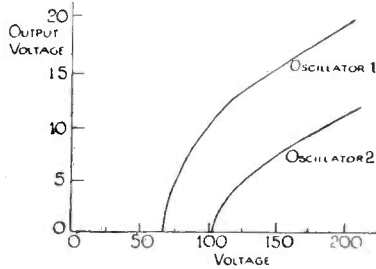

Fig. 3. Output voltage of oscillators 1 and 2 as a function of mains voltage

Figure 3 shows the dependence of the output voltage on the power supply voltage for oscillators Nos. 1 and 2, as indicated.

An upper frequency limit of approximately 90,000 cycles and a lower frequency limit of approximately 1/50 cycle was established with these resistance-capacitance coupled push-pull oscillators providing sinusoidal wave forms. A special circuit for the very low frequency range is described. Other oscillator circuits (including the conventional multivibrator for which  $C_2 = 0, R_3 = 0$ ) were tested to check the conclusions drawn from the formulas obtained.

### Frequency-Independent Impedance Matching

A. Weissfloh (Elektrische Nachrichtentechnik, Berlin, Vol. 20, No. 8).

It is intended to provide matching of impedances over a wide frequency range in the cm wave region. The conventional expedient is to insert a quarter-wave section of a transmission line of characteristic impedance  $Z_0 = \sqrt{R_1 R_2}$ , where  $R_1$  and  $R_2$  are the values of the two impedances to be matched. However, if  $R_1$  and  $R_2$  differ by a considerable amount, a sometimes undesirable frequency-dependence is introduced.

In practice this frequency dependence is reduced by inserting two quarter-wave sections in series, the first transforming the resistance  $R_1$  into  $\sqrt{R_1 R_2}$  and the second transforming  $\sqrt{R_1 R_2}$  into  $R_2$ .

To transform the resistance  $R_1$  into  $R_1$  into  $\sqrt{R_1 R_2}$  a quarter-wave line of characteristic impedance  $Z_1 = \sqrt{R_1 \sqrt{R_1 R_2}}$  is obviously satisfactory. For further transformation into  $R_2$  the characteristic impedance  $Z_2$  of the following section must be equal to  $\sqrt{R_2 \sqrt{R_1 R_2}}$ . The frequency dependence for these combined impedances will be considerably less than that for the single section line.

### Three section transformer

Further improvement in frequency independence may be secured by combining more than two transmission line sections in series. The article is concerned with a geometrical method to determine the most favorable characteristic impedances  $Z_1, Z_2, Z_3$  for three con-

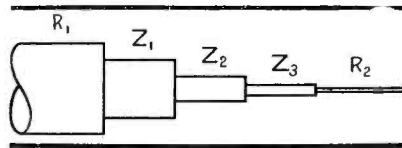

Three section impedance matching transmission line. Expressions for  $Z_1, Z_2$  and  $Z_3$  as functions of  $R_1$  and  $R_2$  are given in article

secutive quarter-wave transmission line sections. Eventually the method, which involves the circle diagram (see for instance Journal of Applied Physics, August, 1944, page 619) and its transformation into a different coordinate system, yields the following relations:

$$Z_2 = \sqrt{R_1 R_2},$$

$$Z_1 = Z_2 \frac{1 + w}{1 - w},$$

$$Z_3 = Z_2 \frac{1 - w}{1 + w};$$

$w$  is found from the equation:

$$\frac{\sqrt{R_1} - \sqrt{R_2}}{\sqrt{R_1} + \sqrt{R_2}} = \frac{2w^3 - 4w}{w^2 - 3}.$$

### Electromagnetic Flow Meter

A. Kolin (Review of Scientific Instruments, May 1945).

An electromotive force is induced in a fluid moving in a pipe at right angles to a magnetic field. This effect is used to measure the discharge of fluid through a pipe by maintaining a known magnetic field. The flow of poor electrolytic conductors like tap water can be measured as well as the flow of a liquid metal like, for instance, mercury.

The advantages of the electromagnetic flow meter consist: 1.) in its linear calibration curve which is independent of the velocity profile, viscosity and density, or temperature, 2.) in an absence of lag which makes the instrument suitable for measurements of instantaneous velocities in rapidly pulsating flows, and 3.) in the absence of any constricting, protruding or movable parts in the flow-meter pipe, which makes the apparatus suitable for metering the flow of, for example, coarse suspensions. Its sensitivity can be made high enough to measure flows in the order of  $10^{-4}$  in.<sup>3</sup>/sec. The chief disadvantage of the device in its present form consists in its limitation to ionized fluids. Theoretically however, the same principle could be also applied to measure the flow of fluid dielectrics.

### Apparatus

The fluid carrying pipe inserted between the magnet poles P is provided with two electrodes E. It is shown that an electromotive force  $V$  across these two electrodes will be equal to:

(Continued on page 154)

Diagram of electromagnetic flow meter

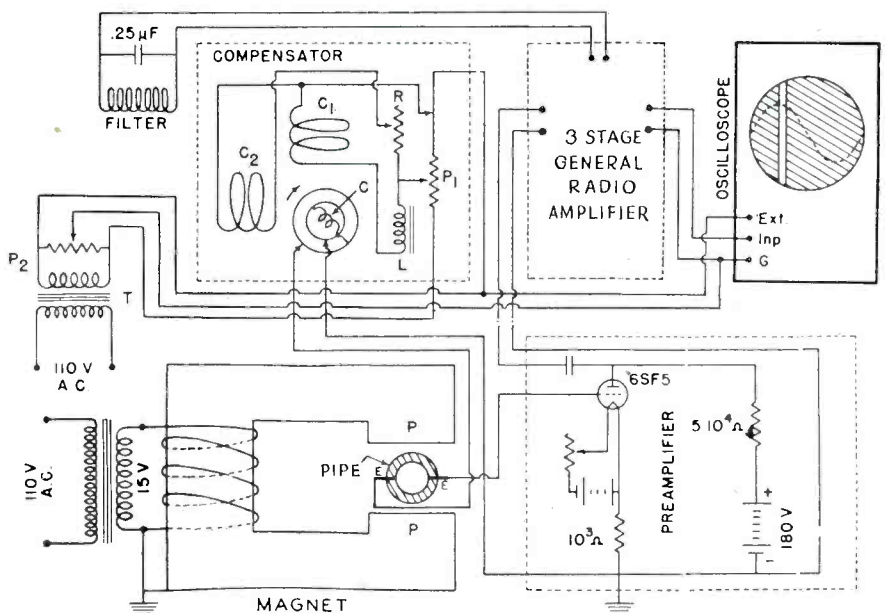

# NEW PATENTS ISSUED

## FM Modulator

The object of the invention is to produce large frequency swings and to operate at relatively high power levels. The specially constructed capacitor 1 is incorporated as tuning element; it is enclosed in a high vacuum so that high voltages may be applied to closely spaced membranes 2, 2' which constitute the capacitor plates. These two plates 2, 2' (preferably of Duralmin) are mounted on stretching rings 3, 3' of conducting material. A large dc polarizing voltage of several thousand volts is applied between the plates; the superimposed audio voltage should be as large as possible, but must never have a peak amplitude exceeding the polarizing voltage.

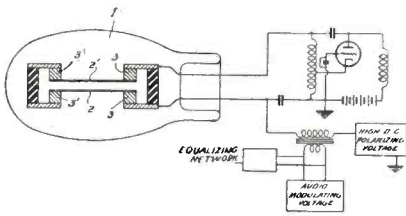

Since a voltage applied between the two plates of a capacitor causes a mechanical force to be exerted between the plates, and since plates 2, 2' are flexible, the spacing of the plates and hence the capacity of the capacitor will vary with the modulating audio voltage. This will result in the desired frequency variation of the voltage generated by the associated oscillator.

It is preferred that the resonant frequency of the membranes 2, 2' approximate the highest modulating frequency; excessive response at this frequency can be avoided by an equalizing network in the audio system or by providing some form of damping.

F. E. Terman, International Standard Electric Corp., (F) March 10, 1942, (I) March 27, 1945, No. 2,372,231.

## Absorption Modulation

The invention relates to amplitude modulation systems for radio telegraph and telephone transmitters; only a small amount of modulating power is required and high percentage of modulation secured.

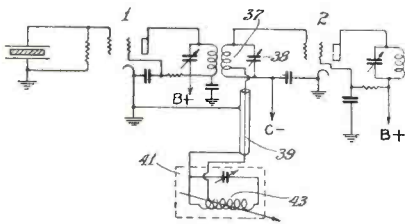

The carrier wave produced by oscillator 1 is modulated by varying the effective impedance of the absorption circuit 41 coupled to the tuned input circuit 37, 38, of the amplifier tube 2. Connecting conductor 39 forms a flexible low impedance transmission line. The absorption circuit may be a variable inductance type microphone, it is tuned to a frequency slightly below or above

the carrier frequency so that when 43 is varied in inductance by the sound input to 41, the energy absorbed from input circuit 37, 38, will be varied correspondingly, thus causing absorption modulation of the input energy to tube 2.

Other embodiments of the invention are shown and discussed. By inserting the microphone at the place of circuit 37, 38, impedance modulation can be obtained. The variable impedance provided by the microphone impedance may be replaced by a reactance tube suitably connected and controlled by the modulating voltage.

J. J. Antalek, The Rauland Corp., (F) May 8, 1942, (I) April 3, 1945, No. 2,372,701.

## UHF Beam Tube

The electron beam is controlled by the potentials applied to cylindrical lenses 5, 7 and 9. It will be understood that the focal length of an electron lens varies with the applied potential and consequently the area covered by the electron beam varies. This effect is used to obtain high frequency oscillations in the output of an electron beam tube.

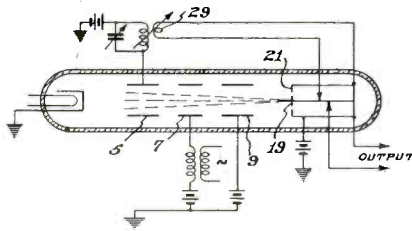

The potential of lens 7 is made to oscillate at the desired high frequency so that the electrons will impinge on either electrode 19 exclusively or on both electrodes 19 and 21. The output circuit may include a feedback connection 29 to establish regeneration or oscillation. If the feedback circuit is adjusted so that high frequency oscillations are generated, these oscillations may be modulated by applying the modulating potential to the lens electrode 7.

It is contemplated to use a plurality of lenses with push-pull input. Velocity modulation which may be introduced by this device can be compensated for by suitably shaping the output electrodes 19 and 21.

E. G. Linder, RCA, (F) October 31, 1941, (I) April 17, 1945, No. 2,373,837.

## Temperature Compensation

The invention is particularly adapted to compensate for frequency drift with temperature in tube circuits. Frequency drift due to change in tube characteristics usually is completed within five to ten minutes; frequency drift due to changes of the associated inductors and capacitors depends upon the ambient temperature and may last an hour. Both effects are compensated for. Also no appreciable change in frequency with variations in heater voltage should occur.

The two capacitors 12 and 13 are dimensioned to have a combined temperature-capacity coefficient to achieve frequency stability. The residual capacitance and the

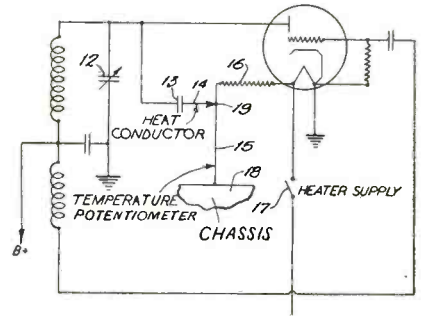

temperature dependence of the circuit exclusive of that of capacitors 12 and 13 are determined and capacitors 12 and 13 chosen to have suitable values and frequency-temperature coefficients to assure stable operation.

The initial frequency drift caused by the heating of the tube is corrected by the "temperature potentiometer" 14, 15, 16, 18, 19. When switch 17 is closed, heater and resistor 16 will start to heat up and a temperature gradient will develop across large lead 15 so that the temperature at point 19 will depend on its position intermediate resistor 16 and the chassis. This is the maximum temperature capacitor 13 will attain. The rate of heating of the capacitor 13, however, will be a function of the length of the thin lead 14. Consequently by adjusting point 19 and the length of lead 14, the final temperature as well as the rate of change of temperature of capacitor 13 can be adjusted to compensate for the change in frequency due to heating of the tube.

The circuit is recommended for devices using as the heater supply the battery charging system of a car, the voltage variation having no appreciable effect on the frequency.

J. F. Bell, Zenith Radio Corp., (F) August 17, 1942, (I) March 20, 1945, No. 2,371,790.

## Beam-Tube HF Generator

According to the invention the collector electrode represented in the drawing is self-resonant, avoiding the necessity for an external resonant circuit and associated stray capacitances; high output frequencies may be generated with the device.

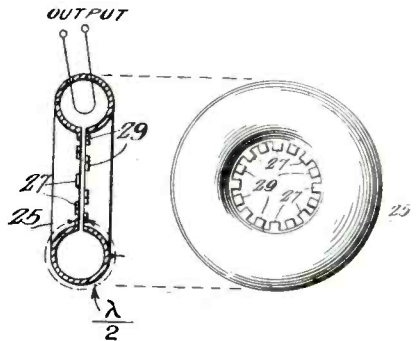

To produce high frequency oscillations a rotating electron beam is intercepted by circularly arranged commutator segments 27 and 29. Alternate segments are connected to opposite ends of a resonant tank circuit.

(Continued on page 146)

# PROJECTION C-R-O TUBE

By RUDOLF FELDT,

Allen B. DuMont Laboratories, Inc.  
Passaic, New Jersey

## High speed photographic recording and projection oscillography facilitated with the new DuMont design

● In the past, the insufficient light output of cathode ray tubes operated in commercial oscillographs has placed an annoying limitation on the photographic recording, and visual observation of high speed transients. In certain cases, instruments have been built in which frequency response characteristics of the electrical circuits exceed by far the possibilities of the tube, since the corresponding light traces produced on the cathode ray tube screen were so dim that no recordings or even satisfactory observations could be made. In the case of recurrent phenomena, which are ordinarily easily discernible by direct viewing or photography, the light output of all commercial cathode ray oscillographs was insufficient for picture enlargement by means of a projection lens system. The solution of both of these problems evidently lay in a cathode ray tube with greatly increased light output. Research on this problem at Du Mont has brought forth the type 5RP multi-band cathode ray tube series.

For any given screen material, there are only two practical methods of obtaining increased light output; either by increasing the beam current or else the accelerating voltage. In the first method the current range is limited by the maximum permissible spot size, since the spot size increases with the current. As the deflection sensitivity is inversely proportional to the accelerating voltage, the maximum voltage which may be applied is restricted by this factor. In addition, the insulation problem of the cathode ray tube heater transformer becomes difficult, with increased voltage since the cathode is at high negative potential with respect to ground. Some improvement has been obtained by the use of the intensifier principle by which the total accelerating voltage is divided into two parts applied before and after deflection. The second

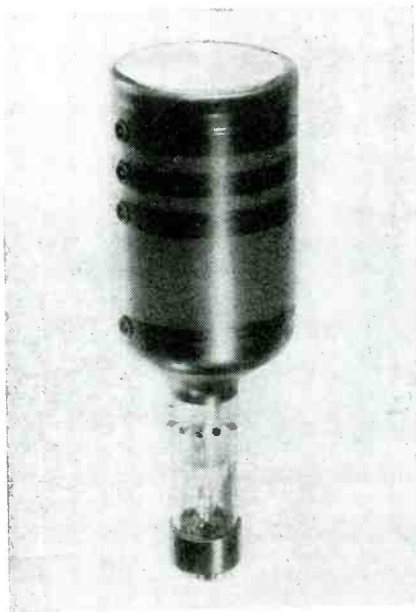

DuMont's multi-band cathode ray tube makes possible the recording of very rapid phenomena which would otherwise remain invisible

anode voltage,  $E_{b_2}$ , is the potential between the negative cathode and the grounded second anode, and the intensifier voltage,  $E_{b_3}$ , is the total accelerating potential between cathode and intensifier terminal.

The difference,  $E_{b_3}-E_{b_2}$  (the so-called post-accelerating voltage) exists between ground and the intensifier terminal. This potential is delivered by a separate intensifier power supply. Here ordinarily a serious limitation is introduced when using regular intensifier type tubes (say of the 5LP- or 5CP- types). If the intensifier voltage is much over twice the second anode voltage, considerable spot and pattern distortion occurs, and only a very small area in the center of the tube screen can be used.

The new high voltage multi-band tube overcomes these difficulties, by means of suitably shaping the tube bulb, by upstepping the intensifier voltage more gradually along the

tube, and by proper location of the three intensifier rings. By rigid application of principles developed during this research program, distortion is kept to a minimum, making it possible to operate this tube with satisfactory results at ratios of intensifier to second anode voltage up to 10:1. In other words,  $E_{b_2}$  may be, for instance, 1500 V, and  $E_{b_3}$ , 15,000 V. Since in this case, the loss of deflection sensitivity is less than 50 per cent as compared to the operation at the ordinary ratio of 1:2 ( $E_{b_2} = 1500$  V, and  $E_{b_3} = 3000$  V), this permits the tube to be operated on standard equipment with standard amplifiers. The loss of the deflection sensitivity can be compensated for easily, by means of either photographic enlargement of the recordings, or by optical compensation in the projection system.

### Element arrangement

As shown starting from the diaphragm base toward the screen, there is located first the electron gun. This is followed by the deflecting plates, the connections to which are brought out through the tube neck; which keeps the capacitance of the deflecting leads low, a distinct advantage for high frequency operation. The contacts to the deflection plates are grouped by pairs and separated by a center contact which is connected to the second anode and normally grounded. The first flush (or button) contact on the cylindrical part of the tube body must also be connected to second anode by means of an external connection. The conductive coating to which it is connected provides shielding of the deflection plates from which the intensifier field and also from external electrostatic fields. The following three flush contacts next to the screen apply the increasing steps of intensifier potential. The tube face is nearly flat, which is a great advantage optically, since it eliminates any dif-

(Continued on page 172)

# NEWS OF THE INDUSTRY

## Components Restrictions Removed by WPB

Reconverting radio manufacturers have been put strictly on their own through elimination of all restrictions which have prevented production of home radio sets. Removal of WPB shackles has come about through amendment to WPB limitation order L-265 which does away with restrictions on the production or sale of component parts and tubes, the only remaining limitation being the quantities which may be purchased under priorities regulation No. 1.

This does not mean, however, that manufacturers may start immediately to produce receivers. It means merely that they may purchase components if and when they are available without interfering with military production. Those components may then be made up into receivers only after spot authorization has been obtained from WPB. End products still restricted are listed as automatic phonograph record players, home recorders and phonograph amplifiers, juke boxes, radio transmitters and receivers, both AM and FM, facsimile and television equipment, public address and intercommunicating apparatus and test instruments.

The Radio and Radar Division of WPB makes plain that present modifications of restrictive orders are in the nature of a test of the industry, and that if it becomes apparent that industry is forgetting its obligations to the military, orders again will be tightened up. To date, very few applications for spot authorizations have been received.

## Meck Forms Audar

John Meck, president of the John Meck Industries, Inc., Plymouth, Indiana, has organized Audar, Inc., a separate corporation which will manufacture and sell public address systems and audio amplifiers as an affiliate of John Meck Industries, Inc. The officers of the corporation are John S. Meck, president; E. W. Applebaum, treasurer and general manager, and Russell G. Eggo, secretary. The Meck Company, now radio manufacturers, formerly made sound equipment, the production of which will now be under the direction of Audar, Inc.

## Bell Researcher Reverting Germany

More than 200 business and financial specialists already have started the work of converting Germany from what it was into a nation of agriculturists and small manufacturing plants impotent to produce further sinews of war. Among these men, Frederick Devereux, long-time Bell Telephone Laboratories researcher, is the ranking man in the hierarchy over Germany. He is deputy chief of the control council's economic division, was at one time mayor of Bronxville, N. Y., and has served in the office of the Army chief of ordnance.



Frederick Devereux. Formerly of Bell Telephone Labs., now deputy chief economic division control council in Germany's re-conversion.



Haraden Pratt, VP and chief engineer American Cable & Radio Corp., takes office October 1 as newly elected chairman of the RTPB.

## RTPB Elects Pratt Its Head

Haraden Pratt, vice-president and chief engineer of the American Cable and Radio Corp. has been elected chairman of the Radio Technical Planning Board. He will take office October 1, 1945, and succeeds Dr. W. G. R. Baker, vice-president, General Electric Co., who has been Chairman since the RTPB was organized in September, 1943.

Mr. Pratt also has been named vice president and chief engineer of All-America Cable and Radio, Inc., and Commercial Cable Co., in which position he will integrate cable and radio engineering of the two companies and the Mackay Radio and Telegraph Co., and is also vice-president of the Federal Telephone and Radio Corp., all subsidiaries of the International Telephone and Telegraph Corp. Mr. Pratt is, in addition, fellow, director, secretary and past president, Institute of Radio Engineers.

## Authorize Five Million Home Sets by March 31

Manufacturers are to be permitted to build some 5,000,000 home radio receivers between now and April 1 next year. Melvin E. Karns, newly appointed director of the War Production Board's Radio and Radar Division, is authority for the statement that WPB will authorize the production of 1,687,000 sets during the last quarter of this year and another 3,375,000 during the first quarter of 1946. This is taken to mean that while there may be a reasonable number of sets on the shelves of dealers for sale before Christmas, the market won't exactly be glutted. Makers still have to hurdle the production barrier represented by components and tube shortages, for authorizations will be made on an if-when-and-where basis—if, when and where sufficient components can be corralled without interfering with military production.

However, cut-backs in the military program are seen with the increasing impotence of Japan and already considerable quantities of surplus materials are finding their way back into civilian industry channels. Last week Director Karns told a meeting of the radio tube advisory committee that he expected to see home radio set production total five million sets by the end of March. Reconversion of the radio industry, he believes, will be quicker and easier than can be the case in any other industry and without danger of interference with the war effort.

## FM for Trucks

A nation-wide truck communications system by FM is disclosed in an application filed by Highway Radio, Inc., with the Federal Communications Commission for permission to equip 100 Chicago trucks with radio units much like those used in thousands of police cruiser cars. Highway Radio hopes to prove that the efficiency of freight handling by motor carriers can be vastly improved and that an average of ten miles now wasted per day per truck can be saved. Time, money and truck wear can be saved by dispatching or holding departing trucks according to information received by radio. Traffic during storms can be made safer by routing trucks over clear roads.

# A POSTWAR PROJECT FOR YOU...

## SUPERSTANDARD RECEIVING TUBES

**SUPERSTANDARD**—above standard; a term coined by Hytron for a standard receiving tube completely redesigned to give improved performance in special electronic applications

● Receiving tube design is often a compromise. Ruggedness, dependability, long life—the very qualities most desirable in industrial electronics and aviation—have often been sacrificed for reduced cost and power consumption in broadcast receivers. Low filament current may be poor economy in an industrial tube. A standard 6SJ7GT may be objectionably microphonic in sound equipment. Vibration, jars, shocks, and inadequate maintenance in the factory may play hob with a standard receiving tube.

### STANDARD — SPECIALLY SELECTED — NOW HYTRON PROPOSES SUPERSTANDARD

**HYTRON IS CONVINCED:** Standard receiving tubes are not right for special electronic applications. Special selection of standard tubes leads to embarrassing replacement problems—does not guarantee permanence of characteristics specially tested, long life, or suitability for operation at not-too-conservative maximum ratings. Hytron prewar ceramic-based low-loss GTX

tubes were but a step in the right direction. The Navy “ruggedized” tube program points the way. Complete redesign of many receiving tubes is mandatory. A tube listing at a dollar in electronic equipment costing thousands and controlling huge production lines is false economy which has already dealt industrial electronics many an unnecessary black eye.

### MAY WE HAVE YOUR OPINION?

- 1 Do you agree that special selection merely results in replacement problems?
- 2 How many thousands of hours of life should **SUPERSTANDARD** tubes have?
- 3 What degree of vibration and shock should **SUPERSTANDARD** tubes be capable of withstanding?
- 4 For what characteristics not now tested should **SUPERSTANDARD** tubes be production tested?
- 5 Would you be willing to pay a premium price for **SUPERSTANDARD** tubes to attain trouble-free operation?
- 6 Should Hytron concentrate on developing **SUPERSTANDARD** tubes usable for many special purposes, and avoid trick and highly specialized tubes?
- 7 How closely should a **SUPERSTANDARD** tube adhere to fundamental characteristics of a standard receiving tube it supersedes?
- 8 Do you believe **SUPERSTANDARD** tubes should have special bases to avoid replacement by inferior standard receiving tubes?
- 9 Should **SUPERSTANDARD** tubes have new type numbers, or the old standard type numbers with a special suffix (e.g., 6SJ7GTS)?\*
- 10 Have we omitted pertinent questions you believe important?

\*NEMA and RMA are now working on type designation systems.

The Hytron **SUPERSTANDARD** tube is as yet an idea—a postwar project for YOU. You who use the tubes can spark the program—can make it come to life. Hytron will put its postwar engineering drive behind the **SUPERSTANDARD** tube, if you will help. Let us know the improvements of specific characteristics your experience has proved desirable. Drop a line today to our Commercial Engineering Department.

OLDEST MANUFACTURER SPECIALIZING IN RADIO RECEIVING TUBES

# HYTRON

RADIO AND ELECTRONICS CORP.



MAIN OFFICE: SALEM, MASSACHUSETTS  
PLANTS: SALEM, NEWBURYPORT, BEVERLY & LAWRENCE

# WHAT'S NEW

Devices, products and materials the manufacturers offer

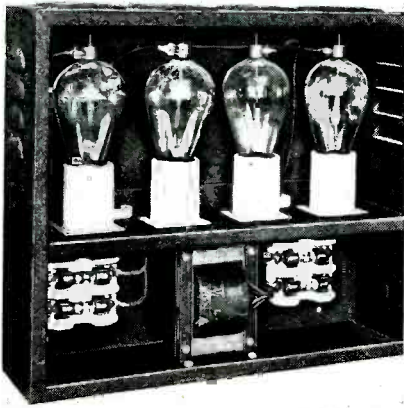

## Electronic Rectifier

A rectifier unit being manufactured by Automatic Electric Co., 1033 W. Van Buren St., Chicago 7, Ill., eliminates the need for re-motoring dc equipment in cases where the commercial current source is changed to alternating current, or where dc equipment is moved into ac areas. It operates on 110 or 220 v., 50-60 cycle ac, and delivers 12 amp full-wave pulsating dc at approximately input voltage, with an efficiency of 80 per cent. Type 50 rectifier uses four hot cathode mercury vapor tubes of the shielded cathode type in a straight bridge circuit, with no transformer except a small 104 w unit for heating the tube cathodes.

## 6-Range VoltOhmmeter

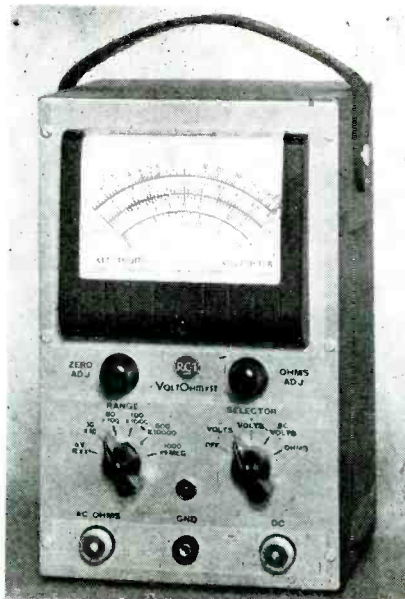

The RCA 195-A VoltOhmmyst combines a 6-range dc voltmeter, an ohmmeter reading from .1 ohm to 1000 megohms, a 6-range ac voltmeter, a linear audio frequency voltmeter, an audio level meter, and an FM discriminator balance indicator. A diode is used for ac measurements. The maker is the RCA Victor Division of the Radio Corp. of America, Camden, N. J.

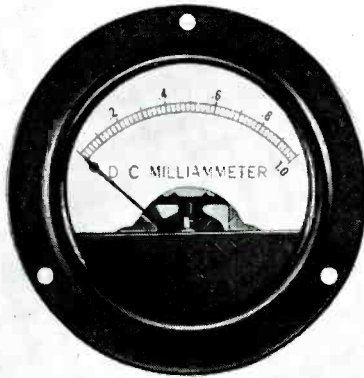

## Sealed Instruments

New hermetically sealed electrical indicating instruments with internal pivot construction in 2½ in., 3½ in. and 4 in., round styles are being produced by the Hickok Electrical Instrument Co., 10528 Dupont Ave., Cleveland 8, Ohio. Body diameter is 3½ in., flange diameter 4½ in., with mounting hole radius 1 15/16 in. These instruments include ac and dc voltmeters, ammeters, milliammeters and microammeters. All sizes are housed in metal cases, hermetically sealed by a clamping mechanism. Their thick flint-hard glass withstands 25 lbs. pressure per sq. in. Terminals are of glass soldered-in type using a direct bond of glass to metal. Instruments are designed to operate at 85 degrees centigrade. High strength Alnico magnets permit same meter to be used on steel panels as well as insulating panels.

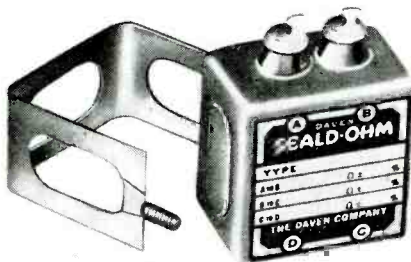

## Precision Resistors

The Seald-Ohm precision resistor is a hermetically sealed unit with spool, or mica-card type non-inductive resistor windings of any resistance value to 1,600,000 ohms. ± 0.1 per cent to ± 10.0 per cent accuracy. May be had to tolerance as close as ± 0.1070. Resistors available with 2 terminals at one end or terminals at two ends. A single four terminal unit is designed to take up to four separate spool-type resistors of different values and accuracies. Electrical connections are brought out through fused glass seals which are soldered in the resistor shield. Resistors can be mounted in vertical, inverted or horizontal positions. Dimensions: 1 9/16 in. wide, 1½ in. high, 7/8 in. deep. Maker is The Daven Co., 191 Central Ave., Newark 4, N. J.

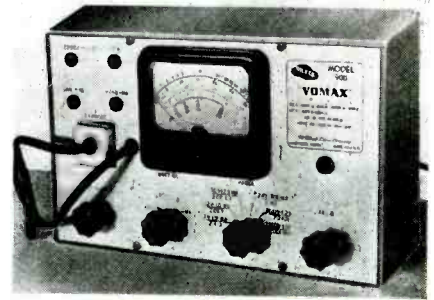

## Vacuum-tube Voltmeter

A new vacuum-tube volt-ohm-milliammeter, the Vomax, has been developed by the McMurdo Silver Co., Hartford, Conn. A total of 12 dc voltage ranges cover .05 through 3000 v at input resistances of 50 and 125 megohms. Six ac voltage ranges cover .05 through 1200 v, all at effective 6.6 megohms and 8 mmfd input loading. Three of these ranges are calibrated —10 through +50 db for power output measurements. Six direct current ranges from 50 microamperes through 12 amperes are provided. Six zero-left resistance ranges cover 0.2 ohms through 2000 megohms. One zero-set knob serves for all 39 ranges, and need be set but once. Only 5 different scales on the 4 5/8 in. meter are required. All circuits are dual-tube, automatically balanced against line voltage variation and tube aging. A removable diode rf probe is provided.

## Panel Instruments

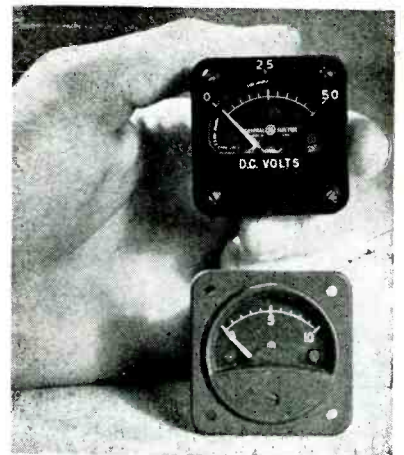

A new line of 1½-in. panel instruments has been developed by General Electric's Meter and Instrument Division, Schenectady 5, N. Y. Two forms are available: a watertight design and a conventional where the instrument will be protected from the elements. The watertight instruments (Types DN-1, DN-2, and DN-3) and the conventional ones (Types DN-4, DN-5 and DN-6) have the same basic design utilizing an internal-pivot element combined with a permanent-magnet moving-coil construction. The pivots are solidly mounted on the inside of the armature shell, instead of being secured to the outside of the armature winding.



## Unusual FACILITIES FOR UHF DESIGN AND POST-WAR PRODUCTION

Two things are vitally necessary for the design and production of UHF equipment . . . specialized knowledge and special equipment. We have both. Lavoie engineers are highly specialized along UHF lines. In our plant, the equipment and shop practice are centered on UHF requirements.

Lavoie service is available to you either in the form of technical recommendations only, or we can develop your ideas in actual physical form. This applies to absolutely new ideas or to the betterment of present ideas. We invite consultation.



### Lavoie Laboratories

RADIO ENGINEERS AND MANUFACTURERS  
MORGANVILLE, N. J.



**UHF HARMONIC FREQUENCY GENERATOR**  
PROVIDES output voltages which are multiples of 10 or 40 megacycles with CRYSTAL-CONTROLLED accuracy.

RECOMMENDED FOR: the calibration of receivers, wavemeters, or using internal beat detector for calibration of oscillators and signal generators.

#### UHF PRECISION FREQUENCY METER

Completely portable  
Accuracy 0.1%  
Battery or  
AC-Operated

Models available from 100 to 1500 megacycles with 2 to 1 frequency coverage on each model. Available only on high priority.



**Specialists in The Development of UHF Equipment  
and in The Manufacture of UHF Antennas**

## **"Big Five" May Clinch Radio Below 25 mc**

The new radio-channel allocations announced by the FCC are now final only for frequencies above 25 mc. From that point down, the allocations have yet simply the status of FCC "proposals." Final ratification of this lower section of the spectrum, it was first thought, would have to await the international radio conference to be held in Rio de Janeiro after V-J Day.

But because aviation frequencies are being held up, causing present international difficulties, it is now believed likely the foreign secretaries of the Big Five of the United Nations at their next meeting in London may act without delay to adopt these radio allocations, making the assignments official as early as March, 1946.

The section of the spectrum still awaiting international approval is clearly indicated on the Radio Frequency chart sent to Electronic Industries readers as a supplement with our August issue. All classifications below 25 mc are shown in detail, but a note at the top of the chart explains, "That portion of the spectrum below 25 mc (25,000 kc) represents FCC's proposal for allocations in this region and is not yet final."

## **RMA Drectors to Meet**

A joint meeting of the Radio Manufacturers Association of the U. S. and the Canadian RMA board will be held at the Westchester Country Club, Rye, N. Y., Oct. 10 and 11. Arrangements are in charge of Bond Geddes, executive vice-president RMA, 1317 F Street, Washington 4, D. C.

## **RCA To Sell Dry Batteries**

A complete line of dry batteries will be added to the RCA list of products. The new line will be placed with RCA tube and parts distributors and dealers associated with the radio industry, and orders will be filled on an allocation basis.

## **Hoffman Expands**

The Hoffman Radio Corp., Los Angeles, in July started construction on a new plant annex, completed the lease of three other buildings and the purchase of a new brick and concrete structure of 32,000 sq. ft. The idea behind the expansion is to consolidate production facilities under one roof.

## **ENGINEERING DIRECTORY IN DECEMBER**

**PLEASE FILL IN  
CAREFULLY  
QUESTIONNAIRE SENT YOU**

With manufacturers announcing their postwar products and plans, **Electronic Industries** announces its **Engineering Directory** to be published in December as an integral section of the magazine.

Directory questionnaires have been mailed to all manufacturers, asking for information for the coming Directory. As always, all listings are printed in the Directory without charge—no cost, no obligation.

But please fill out your answers carefully and mail promptly, so that your company will be correctly and fully represented in this great **Electronic Engineering Directory**.

## **Farnsworth Buys Halstead**



Wm. S. Halstead

Entering the important postwar field of transportation communication and control, Farnsworth Television & Radio Corp., Ft. Wayne, Ind., has acquired all of the assets of Halstead Traffic Communications Corp. including important patents relating to railway and highway radio communications. Farnsworth will transfer to its plant in Fort Wayne, Ind., the Halstead engineering staff as well as that company's laboratory and manufacturing facilities, which heretofore have been in New York City.

Most of the key personnel of the Halstead organization, including members of the engineering staff who have had long experience in railroad radio traffic control, have been added to the Farnsworth staff. William S. Halstead, president of the Halstead company, will serve Farnsworth as consulting engineer on radio communications equipment and traffic control as well as on other phases of electronics. John A. Curtis, vice president of Halstead and chairman of its management committee, has been appointed manager of the Farnsworth communications division.

In addition to the war work it has done for the Government, the Halstead organization has devoted a major part of its time to research and development. This work, which was started with the formation of the Halstead Engineering Group in 1937, has been carried on continually ever since.

## **Philips Foreign Plans**

Recently returned from an extended trip to England, Belgium, and Holland, P. F. S. Otten, president of North American Philips Co., Inc., states that the Philips plants in Holland had from 25 to 30 per cent of buildings badly damaged or destroyed by the RAF bombings of 1942 and 1943, and by the German bombing of September 19, 1944. Greater loss was caused by German looting than by any of the bombings. The plant was stripped of much material and equipment.

More recently, near Minden, Germany, a British Air unit discovered a plant, built in a mountain side, nine floors deep, which had been installed to make thousands of radio tubes daily for the Luftwaffe, and all of the equipment of which had apparently been stolen from the Philips plant in Eindhoven.

With regard to present and postwar plans for North American Philips, Mr. Otten states that their plants are still manufacturing essential war materials under Government contracts. Ample funds for plant reconversion and modernization are available through the present approximately \$20,000,000 resources of Philips' American Trustee. For postwar, North American Philips plans to make quartz oscillator plates, cathode ray tubes, industrial and medical X-Ray apparatus, fine wire, diamond dies, tungsten and molybdenum products and electronic equipment for industry.

## **Electron Equip. Expands**

Electron Equipment Corp., South Pasadena, Calif., has been reorganized, with considerable expansion of production facilities in view, and new officers have been elected. They are: President and general manager, Harrison Matthews; vice-president, William A. Godshall; secretary, Howard Burrell; treasurer, N. J. Redmon. Dudley B. Clark remains chief design engineer.

## **Knights in Chicago**

James Knights Co., Sandwich, Ill., has opened a Chicago office at 175 West Jackson Boulevard. It will be in charge of E. H. Aberdeen.



# METAL ASSEMBLIES AND COMPONENTS FOR ELECTRONIC AND MECHANICAL DEVICES

•  
**ENGINEERING**

•  
**DEVELOPING**

•  
**FABRICATING**

•  
**ELECTRO-FORMING**

•  
**PLATING**

•  
**FINISHING**  
•

**B**ERNARD **R**ICE'S **S**ONS

I N C O R P O R A T E D

MANUFACTURERS OF QUALITY METAL PRODUCTS SINCE 1867

OFFICE: 325 FIFTH AVENUE, NEW YORK 16, N. Y.

WORKS: 139-145 NORTH TENTH STREET, BROOKLYN 11, N. Y.

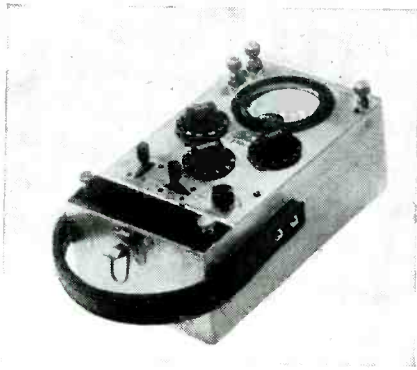

### Lineman's Bridge

A Wheatstone bridge type of instrument is being manufactured by the Nilsson Electrical Laboratory, Inc., 103 Lafayette St., New York 13, N. Y., for use in servicing telephone and telegraph lines. Range of measurement is up to 111 ohms in steps of 1/10th of an ohm, with an accuracy of 1/4 of 1 per cent. Galvanometer has a sensitivity of approximately 22 microamperes per division for 30 divisions.

### High Vacuum Capacitors



Jennings Radio Mfg. Co., 1098 East William St., San Jose, Calif., has added four new units to its high vacuum capacitor series, ranging from 1 micromicrofarad at 7 1/2 amperes, 3,000 peak v., to 250 micromicrofarad at 60 amperes, 20,000 peak v., and a special high power unit at 50,000 peak v., 60 amperes peak. They are available in sizes small enough for aircraft and mobile police equipment and there are units large enough for heavy industrial electronic use.

### Conductivity Cell

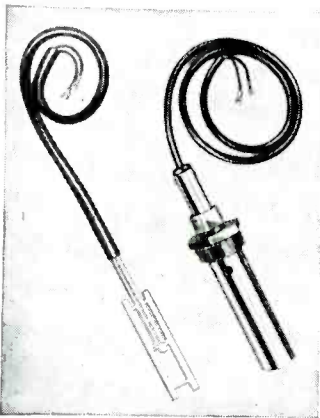

A new type of electrolytic conductivity cell to be used in measuring the concentration of acids, alkalis and salts has been developed by Industrial Instruments, Inc., 17 Pollock Ave., Jersey City. The cell, of heavily walled Pyrex and having platinized platinum sheet electrodes, is made in a number of cell constants—5, 10, 20, 50 and 100. In use, the cell is immersed in the solution to be measured and its resistance determined on a bridge. The indicated resistance may then be translated into the percentage of acid, alkali or salt in the solution.

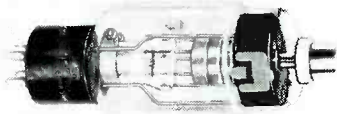

### High Voltage Rectifier

A high voltage Xenon gas filled rectifier, has been developed by Chatham Electronics, 475 Washington St., Newark 2, N. J. The tube operates through an ambient temperature range of -75 deg. C. to +90 deg. C. Characteristics up to 150 cps, include a peak inverse voltage of 10,000 v., peak anode current of 1.0 amp. at 10,000 v., 2.0 amps. at 6,500 v. Average anode current at 10,000 v is 250 ma, and 500 ma at 6,500 v. Tube may be operated in any position. Element structure is supported by three heavy gage rods.

### Rotary Beam Antenna

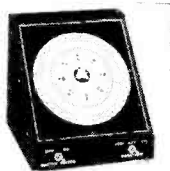
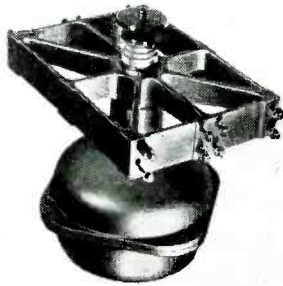

The Gordon Specialties Co., 823 So. Wabash Ave., Chicago 5, Ill., has developed a rotary beam antenna and a station control unit designed to increase signal strength 6 to 9 db. Continuous rotation of the antenna in either direction is made possible by the use of a 3-wire reversible, variable speed, high torque, 110 v., 60 cycle ball bearing motor, with a maximum speed of 1 1/2 rpm. The station control unit features a compass accurate to within 1 1/2 deg., a clearly visible, motor controlled indicator pointer, and a 2-switch control—"off-on", and power motor control for counter clockwise—standby—and clockwise rotation of the rotary antenna.

### High Temperature Capacitors



Silicone impregnated plastic film dielectric capacitors, capable of continuous operation at 256 deg. F. are being manufactured by the Condenser Products Co. of Chicago, Ill. They are available in all standard capacities and voltage ratings.

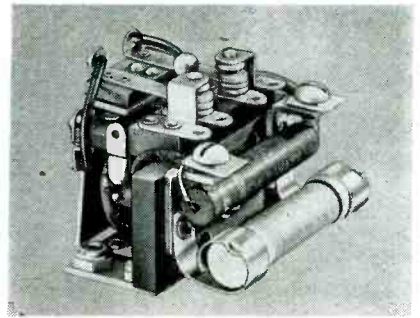

### Flasher Interrupter

A new flasher-interrupter unit has been developed by Electronic Testing Laboratories, 44 Summer Ave., Newark 4, N. J. It comprises a miniature, heavy duty relay, an electro-thermal timing device and a non-inductive resistor unit, incorporated in a single lightweight assembly. The flasher-interrupter is normally furnished in open design but any required enclosure can be supplied, including hermetically sealed or pressurized types. Interruptions can be controlled through a range of from 60 to 80 per minute by varying the current through the thermal unit. Operating voltages include all standard ac and dc ranges and frequencies. Normal actuating current is approximately 200 ma. Units are supplied in: dpdt 15 amps. (non-inductive) at 32 v dc or 115 v ac; 5 amps. (non-inductive) to 220 v ac; spdt 25 amps. (non-inductive) at 32 v dc or 115 v ac; 7.5 amps. (non-inductive) to 220 v ac.

### Power Supply

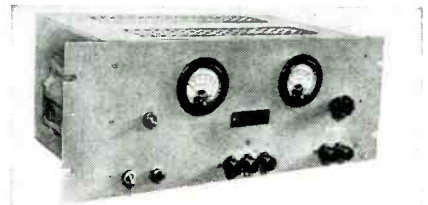

Electronic Measurements Co., 10 West Front St., Red Bank, N. J., is offering a power supply unit supplying continuously variable voltages from 0-325 v dc at 125 ma, 6.3 v ac at 6 amps., center tapped is available. Regulation is within 1 per cent for voltages between 20-325 v, from no load to full load; and within 2 per cent at 10 v, from no load to full load. Hum voltage, including noise, is less than 10 millivolts.

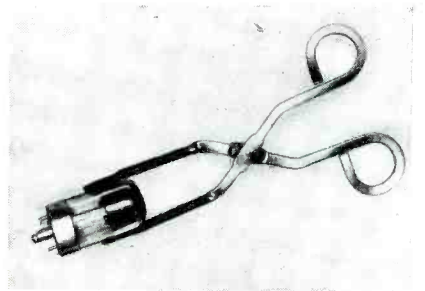

### Tube Extractor

The BMP Co., Boonton, N. J., has developed a new tube extractor, for inserting and extracting miniature and straight-side glass tubes. The gripping surface is rubber-covered. The prongs fit all tubes.



### Dynamic Microphone

The Universal Microphone Co., Inglewood, Cal., is reissuing several microphone types that have been unavailable since the outbreak of the war. Among these is the 204-TA, dynamic handi-mike. Impedance is 35-50 ohms; frequency response 200 to 7,000 cps.; output level into 50 ohm input; 44 db below 6 milliwatts for 100 bar signal. Assembly includes 6 ft. of rubber jacketed two conductor shielded cord.

### Limits Bridge

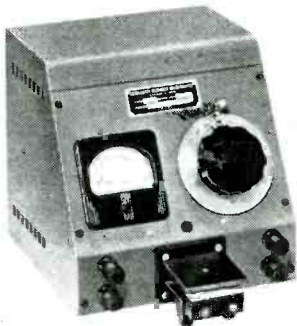

A low range battery operated limits bridge, Model 81., for the rapid comparison of large quantities of resistors having comparable values, is being manufactured by Associated Research, Inc., 231 S. Green St., Chicago 7, Ill. External reference standard, combination test fixture, and automatic control switch are featured. Binding posts are provided for connection to user's test fixture and for connection of reference standard which can be supplied if desired. Overall adjustable range is from  $\frac{1}{4}$  ohm to 10,000 ohms.

### Wire Stripper

A new wire stripper for stripping rubber, asbestos, synthetic, plastic, glass, cambric, and other insulation from single or parallel conductors up to  $\frac{5}{8}$  in. diameter is being produced by the Ideal Commutator Dresser Co., 5194 Park Ave., Sycamore,

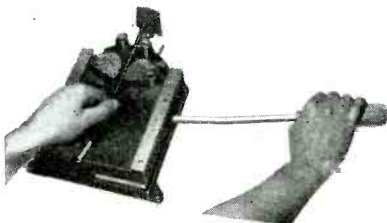

Ill. Plain or grooved blades are used depending upon the type of wire. Important features include straight line pull and elimination of scraping and nicking of wire. The jaws automatically center and grip any diameter of wire without manual adjustment. Jaws instantly release wire at end of stripping stroke. Blades open automatically to receive wire when lever is pushed forward. Blades are quickly interchangeable. The adjustable stop provides for length of stripping. Blades are available in 15 standard sizes.

### Transmitting Tube

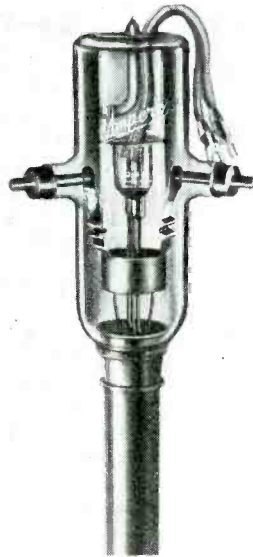

The Ampere Electronic Corp., 79 Washington street, Brooklyn 1, N. Y., has developed a new transmitting tube, Type 233, designed for use as a Class C oscillator or amplifier, at frequencies up to 30 mc and outputs up to 33.3 kw. The use of two grid arms makes neutralization more convenient. It also permits cooler operation of the grid when the tube is used at the higher frequencies either in a self-excited oscillator or power amplifier.

### Frequency Compensated Meters

Weston ac electrical measuring instruments can now be furnished with special forms of compensation to maintain their accuracy over the broad frequency range of from 25 to 3000 cycles. These frequency

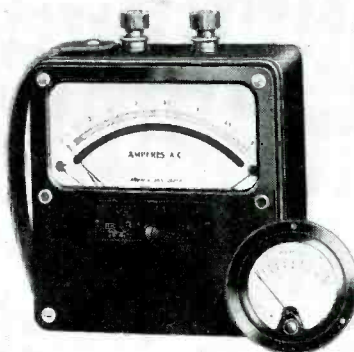

compensated instruments are furnished as ammeters, voltmeters and wattmeters in both portable and switchboard types; they are flat compensated up to 1000, 2000 and 3000 cycles. Maker is Weston Electrical Instrument Corp., 617 Frelinghuysen avenue, Newark 5, N. J.

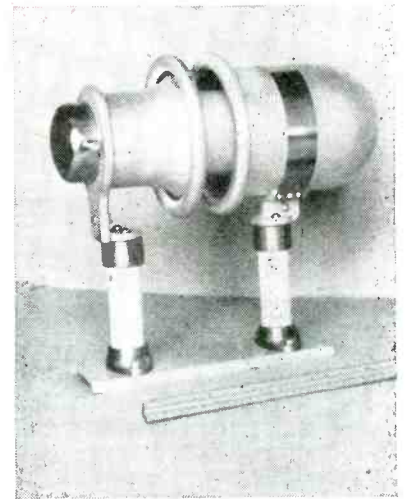

### Neutralizing Capacitor

A new type capacitor is being manufactured by E. F. Johnson Co., Waseca, Minn., for use in transmitters neutralizing circuits. Two sizes are available, rated at 45,000 volts and 35,000 volts peak breakdown, respectively. Capacity ranges are 33.1 to 12.6 mmf. for the former and 26.0 to 7.2 mmf. for the latter. Rough adjustment of capacity is made by moving the outer cylinder under the clamp, and precision settings are made by rotation of a shaft, the location of which may be changed in steps of 45 degrees around the axis of the condenser. Material is spun and cast aluminum. Connections are made direct to aluminum castings and leads may come off at any angle.

### Input Transformers

A new group of input transformers (400 Series) is being manufactured by the Langevin Co., Inc., 37 West 65th Street, New York. A high permeability shield with rotatable strap mounting for minimum stray field pick-up is provided. The 401-A input transformer operates from 30/250/600



ohms primary to 30,000 ohms secondary, center tapped. Type 400-C bridging input transformer has a nominal impedance of 600/15,000 ohms to 60,000 ohms secondary. With proper input circuits, input impedance range is 0/25,000 ohms. The 402-A input transformer has a nominal 30/120 ohms primary to 50,000 ohms secondary. Input impedance range is 0/250 ohms. All types have a maximum operating level 10 vu at .001 milliwatt reference level.

# WASHINGTON

★ ★ ★ ★ Latest Electronic News Developments Summarized ★ ★ ★ ★  
by *Electronic Industries' Washington Bureau*

## LID LIFTED ON CIVILIAN PRODUCTION—

With Victory over Japan, the War Production Board had on its schedule of elimination of controls the revocation of the radio-electronic manufacturing industry's wartime limitation Order L-265. This meant the "starting gun" for civilian production of the huge quantities of home receivers and the transmitters for the more than a thousand projected FM-television-standard broadcasting stations.

## COMPONENTS SITUATION EASED—

The vital tubes and components to launch civilian production of receivers and broadcast transmitters—the bottleneck up to the end of the war—could now be furnished to the manufacturers in adequate supply so their reconversion operations could be started. In fact, the "spot" authorization program of the WPB to permit resumption of civilian manufacturing, which had just been started before the end of the war with Japan, gave a preview to the WPB authorities of the amounts of tubes and components on hand for the start of reconversion.

## DRASTIC MILITARY SLASHING—

While many industries, which had been engaged in war production, immediately felt a sharp slashing off of military services' contracts, the radio-electronics industry fared a little better than nearly all others. For the Army, the Signal Corps contract terminations were sharp except in the case of certain types of electronic apparatus of the latest design in the development stage. The Army Air Forces cut deepest their outstanding orders in conformity with the cancellation of airplane construction which dropped off sharply in nearly all types but transport planes.

**DEEP NAVY CUTS—**The Navy is also engaging in fairly radical slashing of contracts except for certain types of equipment but Commodore Dow's Navy Electronics Division may continue its program of replacing all the old-type radio communications, radar, sonar and electronic apparatus in the Fleet with the latest modernized types. Both the Army Signal Corps, AAF as well as the Navy indicated that a flow of tubes, components and parts may be needed for maintenance and repair and for the U. S. occupation forces in Europe and Japan. But the surplus supply of components will probably be adequate to take up a large portion of these requirements.

**RESEARCH TO BE CONTINUED—**Scientists in the radio-electronics industry have probably gained the greatest laurels of any group on the home front for the successful conclusion of this gigantic war—in fact, atomic bombing was the climactic weapon against the Japs, but radar, coupled with radio for communications, have been in the vanguard of industrial-scientific weapons of winning the war both in Europe and the Pacific. The Federal Government and the Army and the Navy not only completely recognize the industry's contribution but they also are determined to keep alive the close wartime relationships with its research and development.

**\$130 MILLIONS FOR RESEARCH—**Under the program of a National Government Research Foundation Commission, as proposed by Director Vannevar Bush of the Office of Scientific Research and Development, the plan of an annual expenditure of \$130,000,000 which may grow much larger will mean the flow of probably half of that amount into the industry's research establishments. It will be recalled that Commodore Jennings B. Dow, director of the Navy's Electronics Division, and Rear Admiral Harold G. Bowen, Director of Navy Research and Inventions, have both advocated postwar research budgets running up to a minimum of \$25,000,000 a year.

## NEW WPB RADIO-RADAR DIVISION HEADS

—The elevation of Melvin E. Karns, who had made such an excellent record as the official in charge of production programs, to the Directorship of the WPB Radio and Radar Division succeeding Louis Chatten who returned to private industry was deemed a most constructive move in the Division's final lap of guiding the industry's reconversion course. Mr. Karns, an RCA engineer on loan to the WPB, has achieved a fine reputation of dealing with the industry and in keeping an even balance of planning during the recent hectic months. His second-in-command is John Creutz, who succeeded Mr. Karns as Assistant Director in charge of production and brings to that post his valuable knowledge of the civilian production planning of the industry since December, 1942. Mr. Karns is trying to push reconversion as effectively as possible.

**BROADCASTING'S "GREEN LIGHT"—**The wartime "freeze" on new broadcasting radio stations is to be lifted October 7 by the FCC; possibly even sooner because of V-J Day. Up to the end of August over 1,000 new station applications had reached the Commission, the staff of which has been "burning the midnight oil" all month to process the applications for construction permits for approval.

**FM APPLICATIONS ARE HEAVY—**FM is far in the vanguard in the number of new station requests, having about four times as many as for television and standard AM stations. As of August 7, when the "freeze" was lifted, the FM applications on file totalled 451 against 124 for commercial television and 185 for standard broadcast stations, while 22 stations sought for educational broadcasting.

## NEW BROADCASTING STANDARDS SOON—

The new FM rules and regulations, both in the case of engineering standards and operational-program methods, were slated for issuance towards the end of August and television rules likewise had been carded for early issuance. Following the surrender of Japan, the broadcasting industry indicated that it is placing a heavy flow of orders for new transmitting equipment both for new stations and replacement of the wartime apparatus needing modernization.

*National Press Building  
Washington, D. C.*

*ROLAND C. DAVIES  
Washington Editor*

# relays

## IN THE TRAFICOUNTER

The Streeter-Amet Trafficcounter tabs 900 or more overlapping cars per minute at split second contact. As car wheels hit a pneumatic tube stretched across traffic lanes the compression closes an electrical contact on a diaphragm, operating a Guardian relay. The relay responds to every impulse but the Trafficcounter registers only every other impulse to compensate for rear wheel contact.

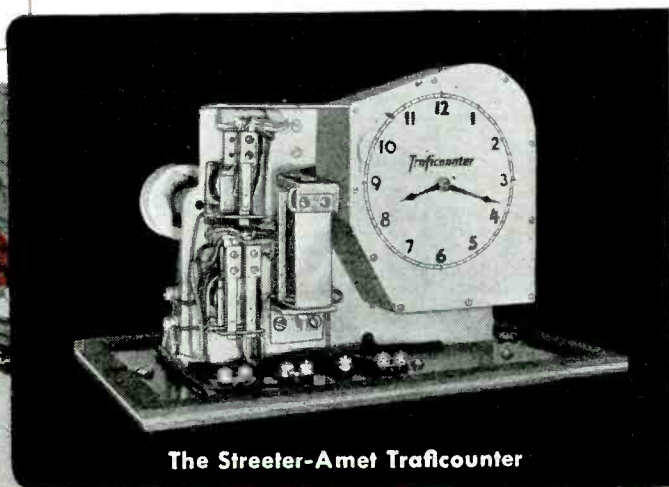

## How *Relays* BY GUARDIAN Count 900 or More Cars per Minute

A grueling job . . . faithfully responding to 1800 or more impulses per minute, hour after hour in rain, heat, and cold the year 'round. For this job Streeter-Amet engineers use Guardian's 6 volt d-c relay, Series 125.

Here is an example of an application that ordinarily calls for a specially built relay. Yet Streeter-Amet finds Guardian's standard relays good enough, dependable enough, and fast enough to do their special job. They save money by buying a standard unit. They get quicker delivery. And they have the comforting knowledge that replacements parts are immediately available if and when needed.

If your application appears to be a "special" it may pay you to look over Guardian's standard relays first. And write us. Guardian engineers will recommend the relay most suitable for your application. If a "special" is really needed they'll help you design it economically.



Series 125 d.c. relay

Also—iron clad and laminated solenoids, stepping relays, magnetic contactors, electric counters, snap and blade switches.

**GUARDIAN**  **ELECTRIC**  
1622-K W. WALNUT STREET CHICAGO 12, ILLINOIS

A COMPLETE LINE OF RELAYS SERVING AMERICAN INDUSTRY

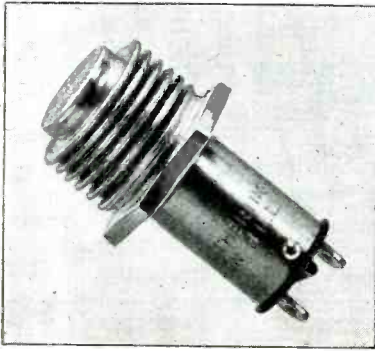

### Switch Protection

Two methods of protecting switches against extremes of heat and cold have been worked out by Robert Hetherington & Son, Inc., of Sharon Hill, Pa. One method involves placement of a bellows on the plunger end of the switch; the other, placement of a rubber boot over the plunger. In temperatures down to 40 degrees below zero, the rubber boot has been satisfactory under many conditions. Where hydraulic fluids and gasoline or other solvents are present, however, or where the switch will meet extremes of heat and cold, the metal bellows is recommended. The bellows or boot is held on one side of the panel; a lockwasher is on the other side.

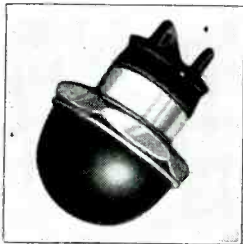

Switches for both industrial and aircraft use can be furnished with total movement of 7/16 in. All switches are completely sealed, back and front, and are made for ac. or dc. Contacts are double break type—solid silver. The DSW switch shown is rated at 10 amperes—110 volts ac., 2 amperes—110 volts dc., 16 amperes—24-28 volts dc. It can also be used on 250 volts ac. circuits, at currents up to 5 amperes. The unit can be furnished normally open, normally closed, 2 circuits or single pole, double throw. With bellows, a pressure of 5 1/2 lb. is required for snapping contacts (without bellows 4 1/2 lb.). Units can be furnished without bellows or rubber boots.

### Paper-Dielectric Capacitors

The General Electric Co., Schenectady 5, N. Y., is manufacturing a new line of hermetically sealed, fixed paper-dielectric capacitors with glass terminal insulators, for use where severe operating conditions may be encountered. The glass terminal

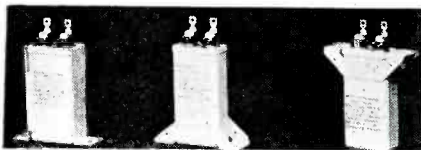

seals are designed to provide an unusually high degree of resistance to humidity, fungus growths, and termites. Single-section and two-section units in capacitance values range from 0.05 to 0.50 microfarad, for voltages of 600, 1000, or 1500 v.

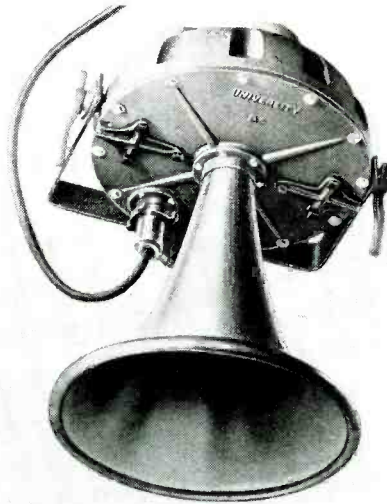

### Outdoor Speaker

A high powered directional loudspeaker, Model B-6, for long range speech projection through high noise levels, is being manufactured by University Laboratories, 225 Varick St., N. Y. 14, N. Y. Range is approximately one mile over open country and two miles over water. Primarily designed for speech reproduction, it has a frequency range of 300 to 5,000 cycles per second and handles 150 watts of audio power. The speaker incorporates blast-proof diaphragms. Water-proof construction permits continuous out-door exposure. Speaker may be submerged in salt water without damage. It is also buoyant in water. Six driver units power the speaker. These are connected in series with a high impedance reactor shunted across each coil. Failure of a coil due to an open connection results in automatic lowering of the shunt reactor impedance and continued functioning of the remaining driver units. Physical dimensions: Diameter approx. 18 in., overall length 24 in. Weight 60 lb. A collapsible tripod type of stand is available for mounting.

### Hermetically Sealed Resistors

Five new types of hermetically-sealed resistors are being produced by the Instrument Resistors Co., 25 Amity St., Little Falls, N. J. Sealing-in process, consists of wax impregnation and oven dehydration. The resistor unit is enclosed in molded bakelite. The case is in two parts with telescope construction at the juncture.

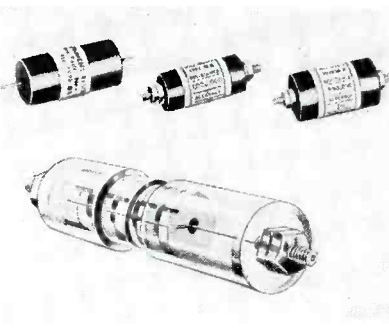

Ceramic spools are used. Some units have 2 in. No. 18 copper axial leads, while others are equipped with 8-32 threaded studs. These resistors provide a range to 1 megohm max. and 2 w max. Standard tolerance 1 per cent. Wound with manganin. Advance or nichrome wire optional.

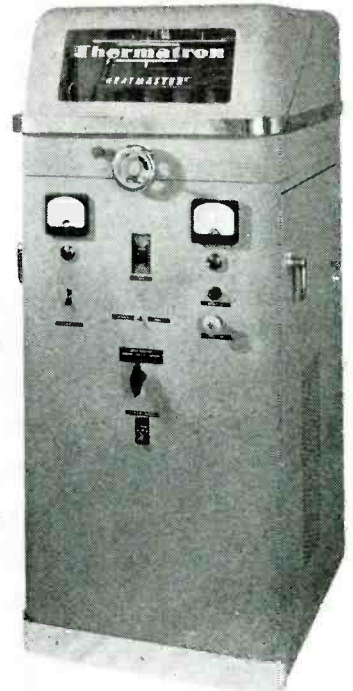

### Dielectric Heater

A new dielectric heater, for plastics, dehydration, sterilization and other purposes, has been developed by the Thermo-tron Division of the Radio Receptor Co., Inc., 251 West 19th St., New York 11, N. Y. The unit incorporates a built-in electrode cage, automatic protection, heavy electrodes and radial-fin air cooled tubes. Other features include safety interlocks, overload relays and circuit breaker, fully calibrated dials. Available accessories are foot control and continuous-belt heating oven. The Heatmaster is capable of heating a 3.3 lb. preform in one minute, or a 5 lb. preform in 90 sec. The type K-5 5 kw output unit has an input of approximately 8 kva. Line voltage is 220 v, 60 cycle, 3-phase. Frequency is 15 or 30 mc; 5 mc optional. Other units which operate at 15 or 30 mc frequency, with a frequency of 5 mc, optional are the Thermo-tron type K-500, 500 w output, type K-1, 1 kw, type K-3, 2 1/2 kw, type K-8, 7 1/2 kw, type K-15, 15 kw, and type K-30 30 kw.

### Dual Amplifier

A new 40 w dual amplifier, the Sound-caster, designed for either plant broadcasting or public address service, has been developed by the Operadio Mfg. Co., St. Charles, Ill. A panel switch permits pre-set



volume selection of voice-paging, music or remote microphone. Model 531 incorporates a 2-speed, manually-operated, record player for 10 and 12 in. commercial recordings, or 16 in. transcriptions. Model 530 features an automatic record-changing mechanism for either 12 10 in., or 10 12 in. recordings.

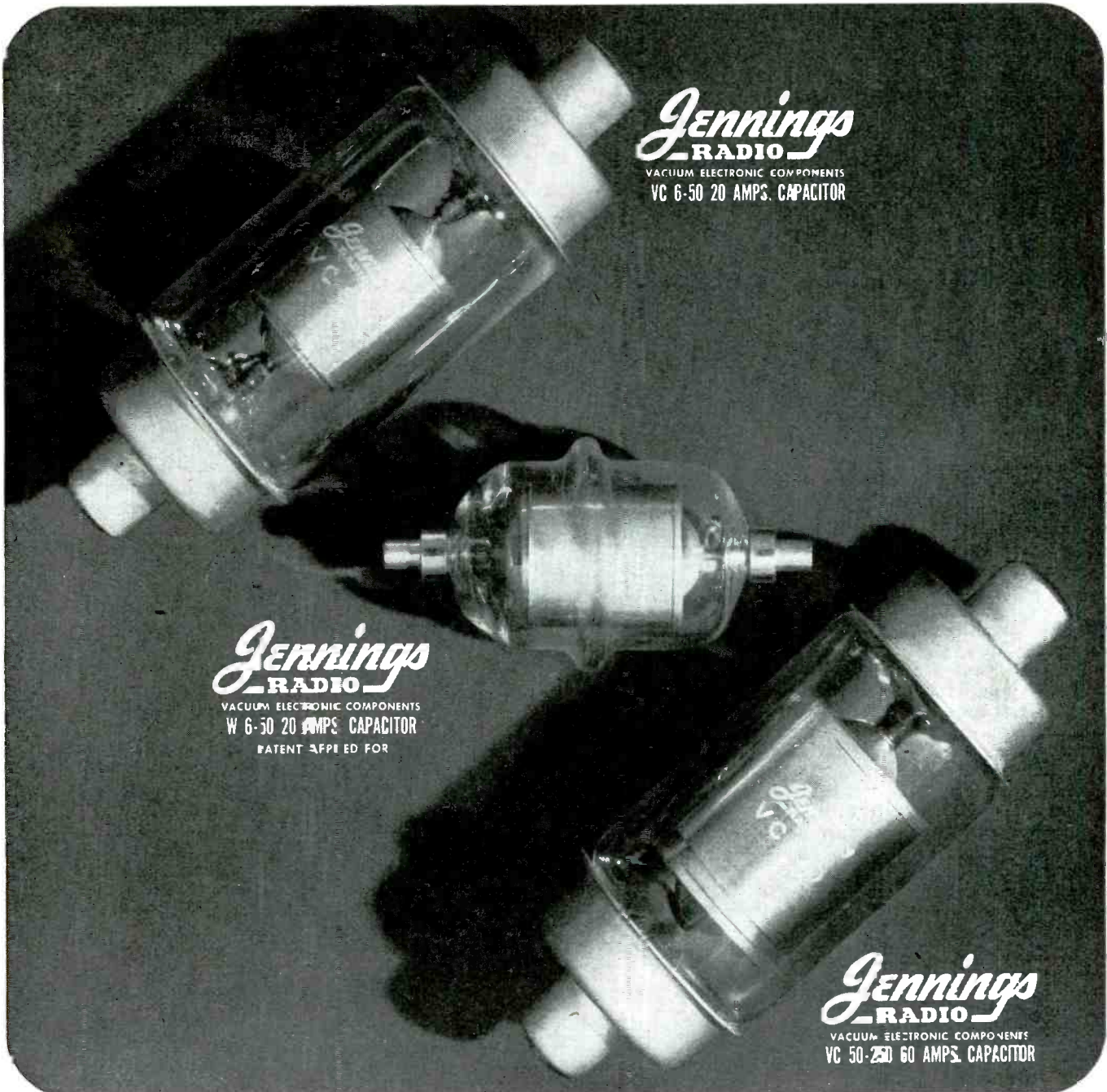

**Jennings**  
**RADIO**  
 VACUUM ELECTRONIC COMPONENTS  
 VC 6-50 20 AMPS. CAPACITOR

**Jennings**  
**RADIO**  
 VACUUM ELECTRONIC COMPONENTS  
 W 6-50 20 AMPS. CAPACITOR  
 PATENT APPLIED FOR

**Jennings**  
**RADIO**  
 VACUUM ELECTRONIC COMPONENTS  
 VC 50-250 60 AMPS. CAPACITOR

THESE PHOTOGRAPHS ARE REDUCED LESS THAN 1/2 ACTUAL SIZE

## JENNINGS LEADERSHIP IN HIGH VOLTAGE VACUUM CAPACITORS *meets urgent need for newly designed electronic equipment*

Jennings research laboratories are constantly developing new and major improvements to help serve the armed forces in their many fields of activity. They also serve the constantly grow-

ing demand for "the unusual" in capacitor usage in the newly designed heating equipment serving the American Electronic Industrial field. We welcome the opportunity to serve you.

Watch Jennings for new developments in the field of Vacuum Electronic Components

WRITE FOR BULLETIN E. I.

**JENNINGS RADIO MANUFACTURING COMPANY • 1098 E. WILLIAM ST. • SAN JOSE 12, CALIFORNIA**



# TELEVISION TODAY\*



## New Developments in the Video Field

### Where Will Television Be By Summer, 1946?

"Our guess estimate is that by Summer, 1946, instead of the present nine television stations, there will be a minimum of twenty stations in actual operation," states Television Grey Matter, issued by Grey Advertising Agency, Inc., 166 W. 32nd St., New York 1, N. Y. "We guess also that there will be no less than 200,000 receivers in homes by Summer, 1946. These figures are not based on any current plans; they are based simply on our absolute conviction that reconversion in this industry will move much faster than anyone now believes or admits. From then on, television stations and receiving sets will multiply at an extraordinary rate. Perhaps no other major industry has expanded its production facilities so enormously during the war. Even if only half of this potential is turned to civilian production by Summer, 1946, the industry will be able to turn out several hundred per cent more sets and equipment than it did in 1940!

"We contemplate, then, a maximum television audience by Summer, 1946, of some 800,000 people—assuming that, with family and friends, each of the 200,000 television sets will have an average of four viewers for major programs. By Fall, 1946, that audience may very well total 1,200,000 and by the end of 1946 it may reach 2,000,000.

"Don't conclude that this will be a 'class' audience. It will be a typical cross-section of our population. But it will be a 'fan' audience, deeply interested, highly responsive."

### British Video Plans

British television engineers expect that video service will be resumed in England on the 405 standard in May, 1946. That is the prediction of Capt. A. G. D. West, English television expert now visiting the United States. It is expected that about 80 per cent of England's population will be able to receive pictures from seven transmitters located within the next three years in such cities as London, Birmingham, Manchester, Leeds and Bristol.

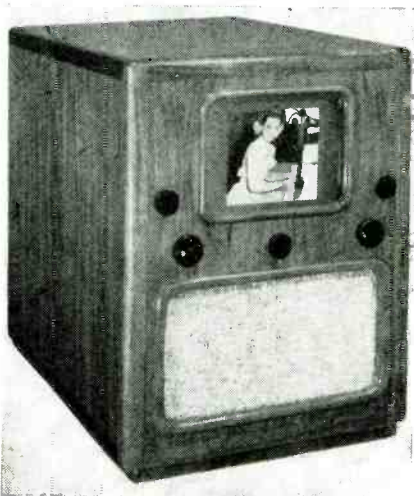

Viewtone's hundred dollar television receiver has a 7-inch tube in a modernized cabinet

### \$100 Tele Set

Viewtone Co., 203 East 18th street, New York, is preparing to make and market a table model television set with a seven-inch tube "for \$100 or less." The set was demonstrated late in July and is intended to be one of a line which will include a console type with either a 5 x 7 or a 10 x 12 in. screen, the latter to sell for about \$175.

### RCA-NBC Test New 288 MC Tele Xmitter

Scaffolding atop the Empire State building in New York marks the start of preparations to conduct the first full-fledged field tests in the metropolitan area to study problems faced in using higher frequencies for television broadcasting.

Dr. C. B. Jolliffe disclosed that the tests, which will be conducted in cooperation with engineers of the National Broadcasting Co., will use a new television transmitter capable of developing 5 kilowatts of output power at 288 mc, a somewhat higher frequency than that assigned at the present time by the Federal Communications Commission for commercial television transmission.

O. B. Hanson, vice-president and chief engineer of NBC, declared: "Our intention in erecting this transmitter is to ascertain the service area of, and to make other observations regarding, a transmitter operating in these higher frequencies and to make a record of our findings." The experimental antenna being installed atop the Empire State building will in no way affect the regularly scheduled television broadcasts from there by NBC's station WNBT.

### NBC'S 288 mc EXPERIMENTAL TELEVISION ANTENNA

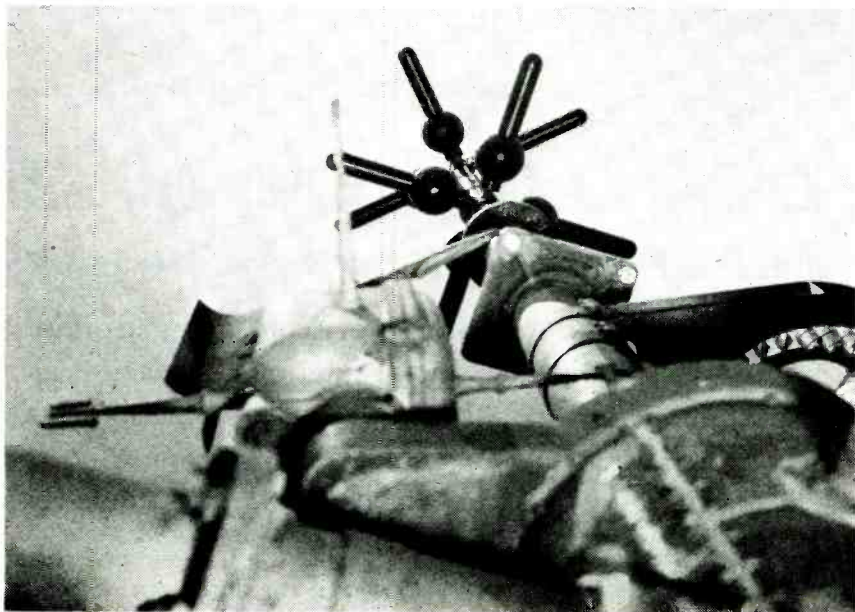

Worm's-eye view of the new type television transmitting antenna which has been erected atop the Empire State Building, New York, to permit NBC to experiment in region of 288 mc

\*Title registered U. S. Patent Office.



Picture These  
**HARVEY REGULATED**  
**POWER SUPPLIES**  
 In Your Laboratories

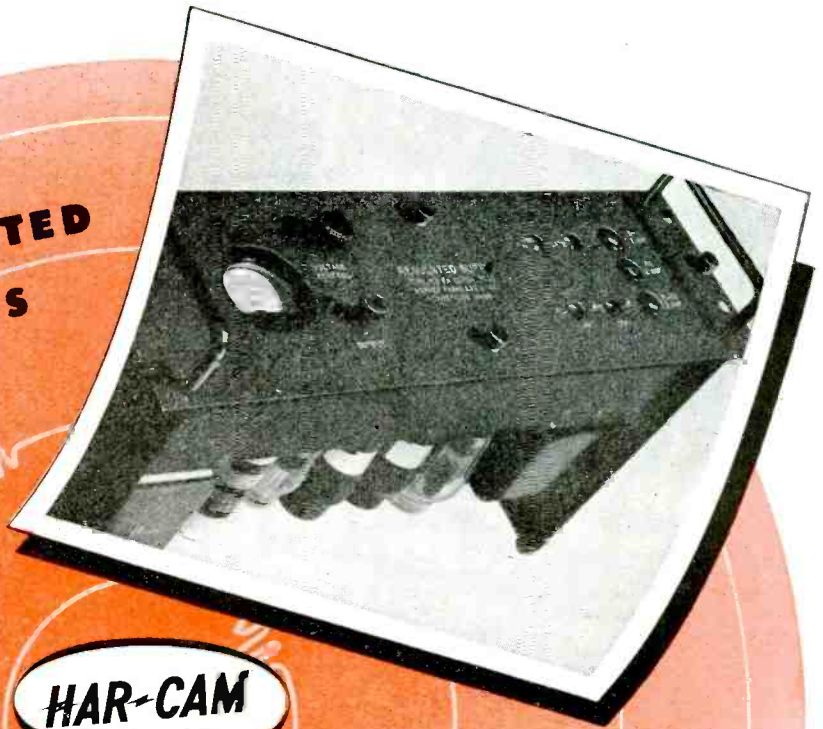

**The HARVEY Regulated Power Supply 106-PA**

meets every need for a controllable, dependable source of laboratory D.C. power between 200-300 volts. Operates from 115 volts A.C. ... output remains constant even though line voltage varies between 95 and 130 volts. Ripple content is better than 10MV ... two separate filament voltages available ... 6.3 volts, 5 amps. each ... parallel operation possible making 6.3 volts at 10 amps available. D.C. voltmeter for measuring output. A model of efficiency and convenience.

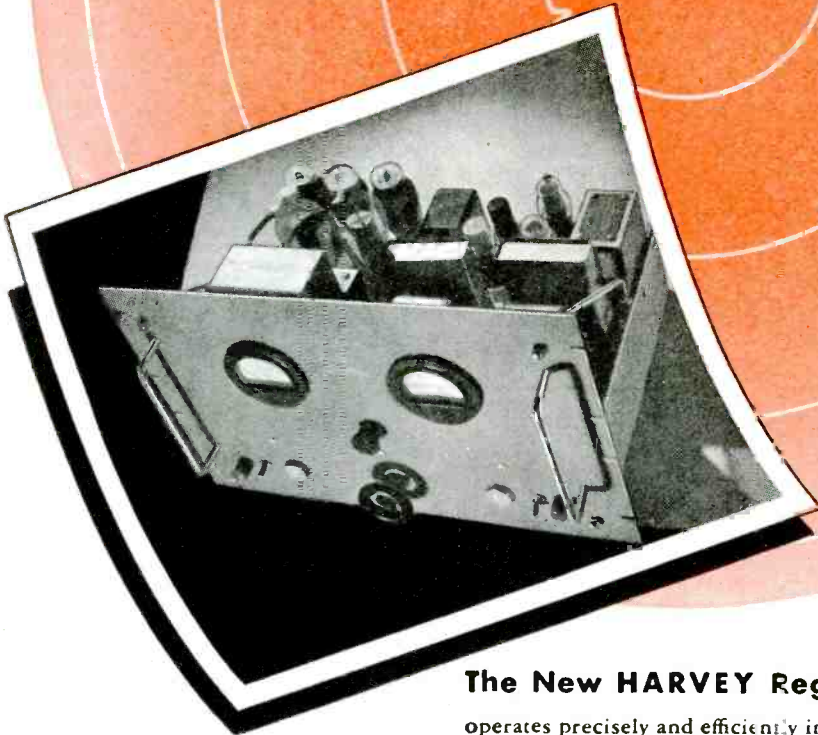

**The New HARVEY Regulated Power Supply 206-PA**

operates precisely and efficiently in the 500 to 1000 volt range. It provides a regulated flow of D.C. power in two ranges: 500 to 700 at  $\frac{1}{4}$  amp; 700 to 1000 at  $\frac{1}{5}$  amp. Ripple content  $\frac{1}{10}$  of 1% or better in any voltage ... 300 MV at 1000 volts or better. Output is constant within 1% from no load to full load in each range; regulation 1% or better. The HARVEY 206-PA has many safety and operating features that make it as easy and convenient to use as the 106-PA.

If your equipment includes Pulse Generators, Constant Frequency Oscillators, Amplifiers, Measurement Equipment or other apparatus requiring a constant source of D.C. Power, you should look into these HARVEY Regulated Power Supplies. We'd be pleased to send the latest bulletins on either or both. No obligation, of course.

**HARVEY RADIO LABORATORIES, INC.**

441 CONCORD AVENUE • CAMBRIDGE 38, MASSACHUSETTS



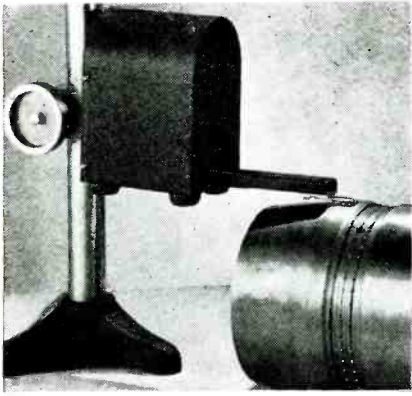

### Measuring Head

The Brush Development Co. of Cleveland, Ohio, is manufacturing a new rough-finish measuring head, designed for checking the rougher surface finishes and waviness in metals, glass, plastics, plated and painted materials. Irregularities of 100 to 3,000 microinches, peak to valley, are accurately measured by the pickup and drive head.

### Capacitor Mounting Clip



P. R. Mallory & Co., Inc., Indianapolis, Ind., has developed a new capacitor mounting clip that requires no tools for assembly. It is available in 5 sizes from  $\frac{5}{8}$  to  $1\frac{3}{8}$  in.

### Tube Sockets

A new series of transmitting and receiving tube sockets molded of Mykroy has been developed by Electronic Mechanics, Inc., 70-86 Clifton Blvd., Clifton, N. J. Included are: standard 4, 5, 6 and 7 prong type; octal and loctal sockets for multi-prong tubes; 5 and 7 prong acorn sockets; and 4 prong high voltage rectifier sockets and improved heavy duty "50 watters."

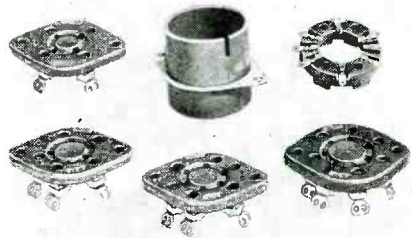

The sockets, produced by compression molding and of one-piece construction, feature spring phosphor bronze contacts, anchored to the sockets by a method which assures rigid non-turning position. Top surfaces are perfectly flat and smooth to permit unimpeded mounting beneath chassis. Spring action clips provide firm contact with tube terminals.

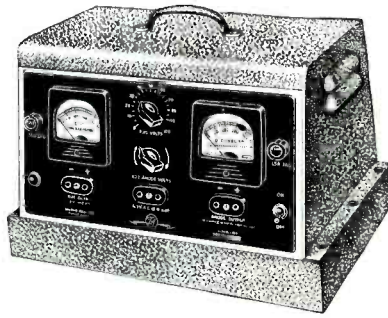

### Self-Regulating Power Pack

The model 1220 EB pack now being manufactured by the Technical Apparatus Co., 1171 Tremont St., Boston 20, Mass., provides two voltage-regulated dc outputs covering the ranges commonly used for anode and bias voltages. The high-voltage output is continuously adjustable from zero to 400 volts with voltage automatically held at its initial setting under load variation from zero to full current. Maximum current output on the anode supply is 250 ma; maximum power output is 40 watts. Regulated bias voltage is continuously adjustable from minus 100 volts to zero at maximum current of two ma. Instrument and line fuses are replaceable from the front of the panel. Unit is enclosed in a steel housing 13 in. x 11 in. x 9 in., contains oil-impregnated, oil-filled capacitors, and is anti-fungus treated.

### Plastic Plates

The Pennsylvania Plastics Corp., 5025 Liberty Ave., Pittsburgh, Pa., has developed a gummed plastic plate that will adhere to any clean surface when moistened with any solvent such as benzine, naphtha, etc.

### Triangular Tower

A 90-foot Blizzard King tower can be erected by three unskilled men in ten hours because of simplicity of construction and small size and weight of individual members. Average weight of each member is 5.3 lbs.—heaviest is only 8 lbs. Each 6

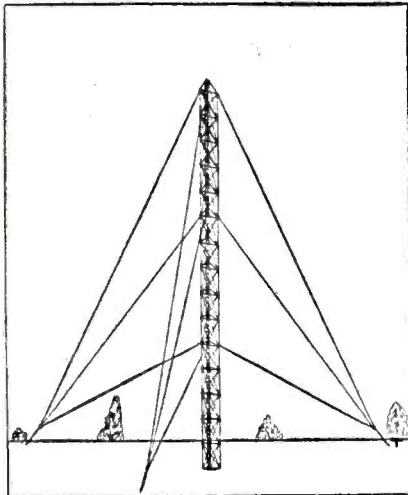

foot section is used as a platform upon which to erect the next section. The members consist of sleeve connections, tubular corner posts, horizontal steel channel members and diagonal flats. After any one section is completed and the ladder installed, the three corner posts of the next section are dropped into place. The sleeve connections are slipped over the top of the corner posts and the horizontal channels are bolted in place and followed by the diagonals. The ladder is then installed and the operation repeated. Maker is Harco Steel Construction Co., Inc., 1189 East Broad St., Elizabeth, N. J.



### Power Line Filter

A new power line filter designed by the Filterette Division of the Tobe Deutschmann Corp., Canton, Mass., for use with screen rooms, prevents entrance of objectionable line noise at all frequencies from 150 kc to 400 mc. The new unit provides attenuation better than 60 db over the entire band. Designed for continuous operation at 500 v dc or ac at a full load current of 100 amperes, the broad band screen room line filter is available for installation in two-wire and three-wire circuits. It is contained in a welded housing of 16 gauge steel with knock-outs at each end to accommodate 2 in. conduit; a removable cover is attached by four screws. The three-wire filter is 23 in. long by 12 in. wide by  $4\frac{1}{8}$  in. deep; the two-wire filter is 20 in. long by 8 in. wide by  $4\frac{1}{8}$  in. deep.

### Telephone Battery Chargers

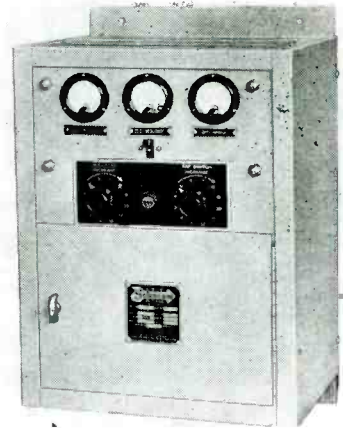

Fully automatic telephone battery charges for operation over a wide range of power line voltages and load requirements are being manufactured by Federal Telephone and Radio Corp., 67 Broad St., New York 4, N.Y. A selenium rectifier in operation from single-phase, 60 cycle power lines of 110, 130, 200, 220 and 250 v is used. Units provide direct current outputs ranging from 2.4 to 16 amperes for from 12 to 60 cells. Output voltage ranges from 2.1 v per cell at high rate charge to a trickle volt charge of 2.5 v per cell. Battery potentials are automatically maintained within selected limits by a voltage control relay circuit which varies the charge between high and trickle rates, both of which are adjustable. Operation without automatic regulation is possible, permitting the rate of charge to be adjusted manually when desired. The dc output circuit is filtered to prevent the introduction of noise on telephone lines. The ripple component does not exceed 40 millivolts at full load. An alarm circuit is provided to indicate failure of charger or battery circuits, both of which are equipped with fuse protection and overload switches. A voltmeter on the front panel indicates battery voltage; separate ammeters show charge and load currents.

**A  
DISTINCT ADVANCE  
IN  
BRACKET  
DESIGN**

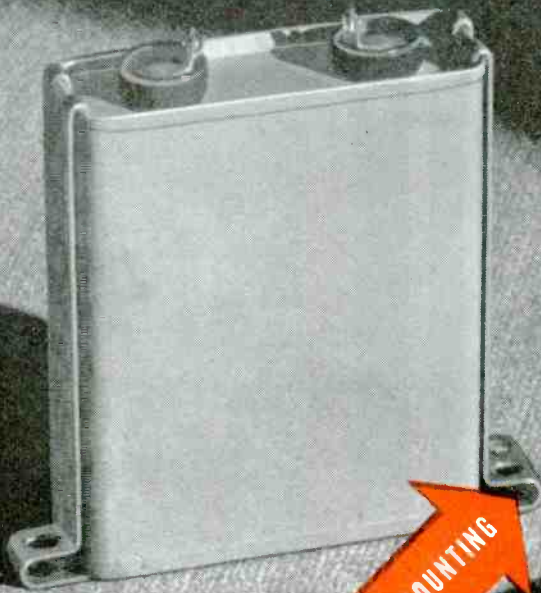

**BASE MOUNTING**

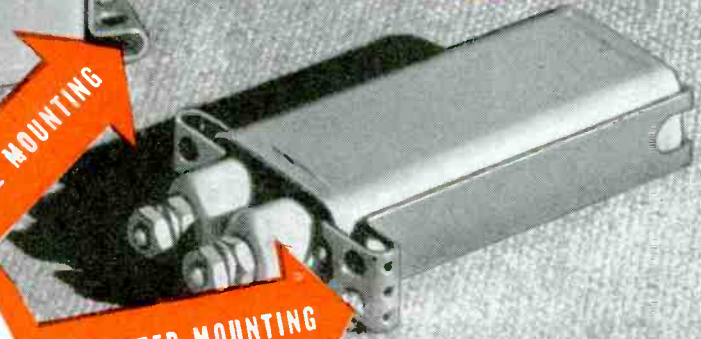

**INVERTED MOUNTING**

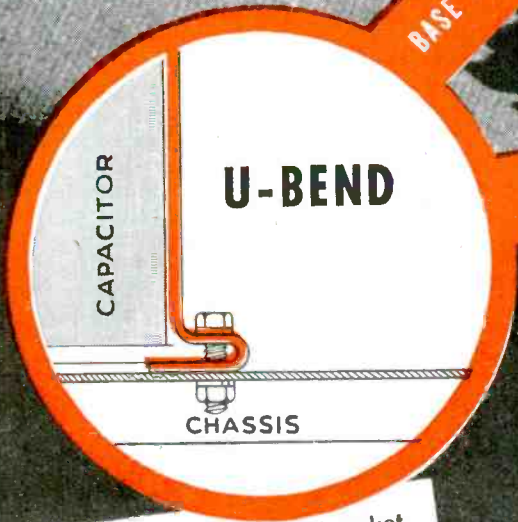

1. Provides "spring-washer" effect for secure capacitor mounting.
2. Reduces strain on capacitor and chassis.
3. Compensates for manufacturing tolerances in height of case.

This removable mounting bracket is now available for most G-E rectangular a-c and d-c capacitors, permitting the capacitor to be mounted upright or inverted.

In contrast with the conventional L-shaped bracket, this U-bend construction minimizes the stress on the metal chassis and prevents distortion when mounting bolts are tightened. The mounting foot is sufficiently flexible to compensate for normal tolerances in height of case, and for variations in dimensions of the bracket itself.

The brackets are sufficiently thick to provide strong, rigid support. A cor-

rosion-resistant finish of lacquered zinc plate assures a good ground from capacitor to chassis. The brackets have either one or two mounting holes depending upon the width of the capacitor.

These brackets are an exclusive feature on G-E capacitors. Spade-type and L-shaped brackets can still be obtained when desired. Ask for Bulletin GEA-4357 for information on the G-E capacitors that can now be furnished with this improved feature. *Apparatus Dept., General Electric Company, Schenectady 5, N. Y.*



**CAPACITORS**

Buy all the BONDS you can  
—and keep all you buy

**GENERAL  ELECTRIC**

407-96-6700

**SPECIALLY DESIGNED**

# AUDIO TRANSFORMERS

*For the Electronic Industry*

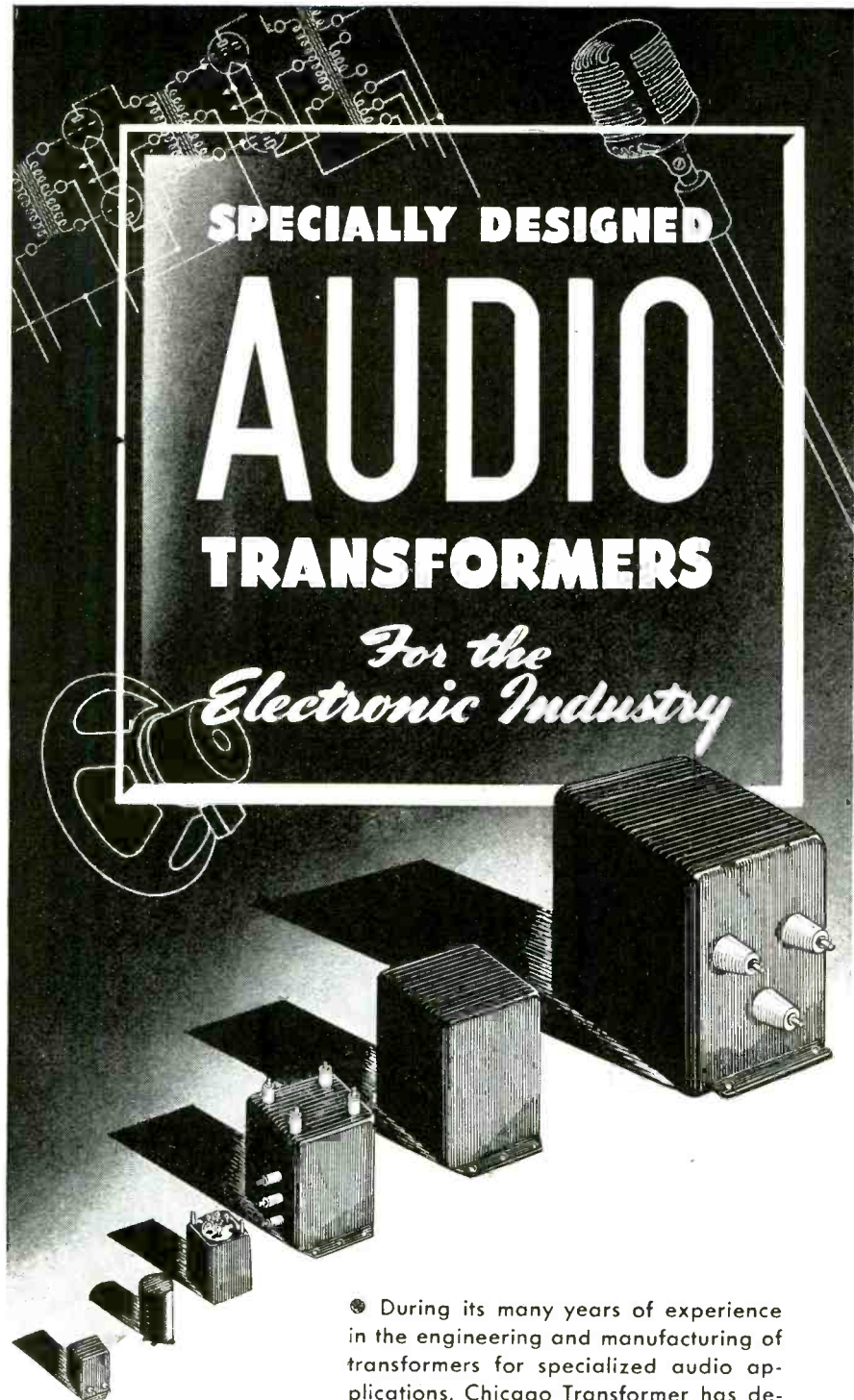

**Also makers of . . .**  
 Power transformers for radio and other electronic circuits, vibrator power transformers, audio and filter reactors, instrument transformers, auto and control transformers, wave filters, fluorescent ballasts and ignition coils.

• During its many years of experience in the engineering and manufacturing of transformers for specialized audio applications, Chicago Transformer has designed and produced a wide variety of types, from the tiny units used in walkie-talkies to large size modulation transformers. If you have a design problem involving transformers in audio or other types of circuits, let this well qualified organization be of service to you.

## CHICAGO TRANSFORMER



DIVISION OF ESSEX WIRE CORPORATION  
 3501 WEST ADDISON STREET  
 CHICAGO, 18



### RADIO DOOR ACTUATOR

(Continued from page 97)

The circuit may be resonated as shown by a variable capacitor shunting the transformer secondary. Another satisfactory tuning arrangement uses a line-to-grid transformer provided with a 500-ohm primary winding tapped at 4 to 8 ohms. As indicated in Fig. 1, the total primary is shunted by the tuning capacitor and the low impedance loop connected to the low impedance terminals. The complete receiver-relay is shown in Fig. 1A.

In this application, with the receiver interconnected with the electrical circuit of a garage door operator, it will have extremely long standby periods and short operating periods. It follows that, during standby periods, the receiving apparatus must consume little or no power line energy to reduce operating costs, yet must be instantaneously responsive to the receipt of the actuating signal. The cold cathode tube used in the disclosed circuit requires zero standby power.

The standby energy consumption of the entire circuit is determined by the power dissipated in the three resistors and may be in the order of one-half to one-quarter of one watt. Obviously, other more sensitive receiver-relay circuits, such as the superregenerative circuit, could be used. Such circuits, however, require hot cathode discharge tubes which are subject to progressive filamentary or cathode deterioration. Even though hot cathode tube circuits could be designed for equally low standby power, their reliability would be impaired by shorter life and their cost increased by a higher maintenance expense.

While the costs of the induction and photoelectric receiver-relays are of the same order, the transmitter costs are widely divergent and favor the photoelectric method. In the photoelectric system a small spotlight, or the existing automobile headlights, may be used for transmission and little or no additional expense is incurred. In the induction system, to excite the receiver-relay shown in Fig. 1, a low frequency alternating current generator having from one to five watts output is desired. Such generators, by themselves, are too expensive to enable induction linkage to compete with photoelectric linkage on a cost basis.

A method (for which a patent has been applied) has been devised, however, for the provision of induction remote control transmitters at a negligible cost by modifying a standard automobile receiver. Automobile receivers are becoming increasingly popular to the point of no longer being considered auxiliary equipment, as evidenced by the fact

(Continued on page 134)

Aircraft Stresses in Giant Wind Tunnels Registered Through

# CLARE "Custom-Built" RELAYS

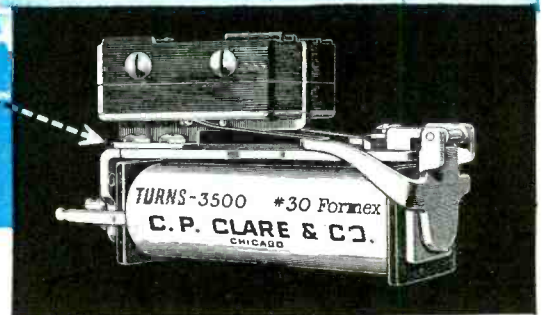
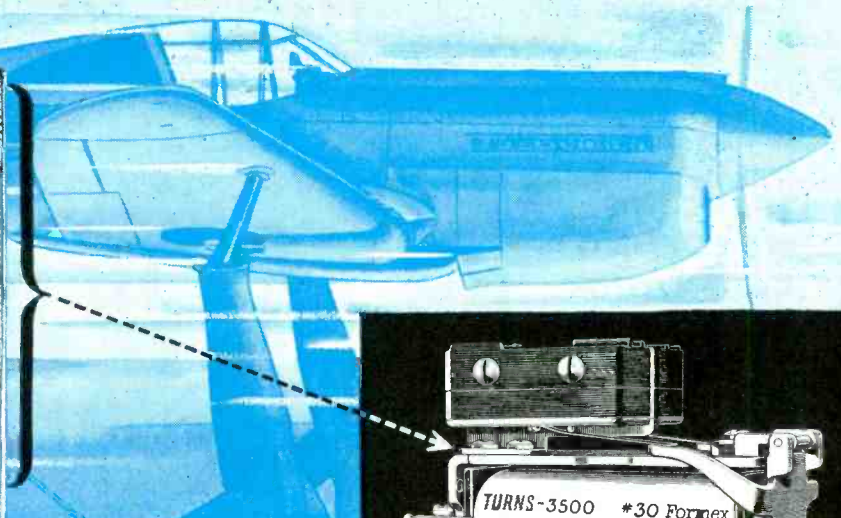
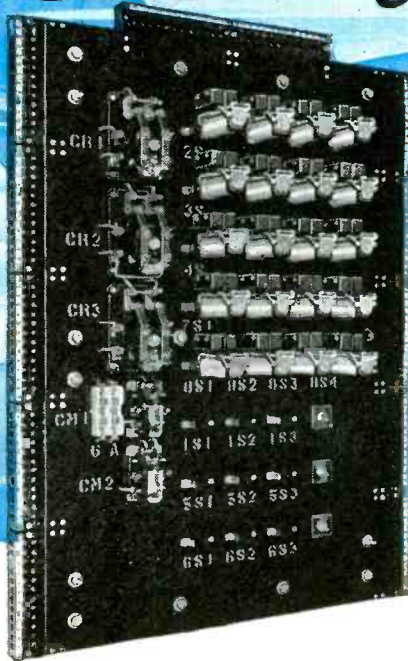

CLARE "Custom-Built" TYPE "AMS" RELAY

Twenty-nine Clare "Custom-Built" Type "AMS" Relays are used in this control panel, manufactured by the Toledo Scale Company of Toledo, Ohio, to register the effects of wind pressure on aircraft in giant wind tunnels.

Having used Clare "Custom-Built" Relays for a number of years as components of their sensitive automatic weighing machines, the Toledo Scale Company did not hesitate to pick Clare Relays for this highly specialized aircraft testing equipment.

The Clare Type "AMS" which is used in this application has the same characteristics as the Clare Type "A" a.c. Relay except that enclosed snap-action switch contacts are provided. These contacts have a high current rating and make a relay for sensitive operation with heavy duty contacts. A maximum of two switches may be mounted on one relay.

This application of Clare "Custom-Built" Relays to operate delicate and highly specialized controls is typical of the way in which engineers and designers are making use of the Clare principle of "custom-building" to obtain just the relay for the specific job.

Clare Relays offer the designer the widest possible selection of contact ratings, innumerable combinations of contact forms, flat or hemispherical contacts of rare metals or special alloys, coil windings to match the circuit and application.

Submit your relay problem to Clare. Let our engineers work with you in developing a Clare "Custom-Built" Relay that will exactly meet your requirements. Send for the Clare catalog and data book. Address C. P. Clare & Co., 4719 West Sunnyside Avenue, Chicago 30, Illinois. Sales engineers in all principal cities. Cable address: CLARELAY.



Armature bearing consists of a stainless steel bearing pin operating in an oil impregnated yoke insert.

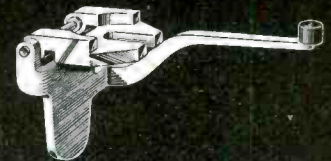

Coil core of Type "A" Relay is of laminated silicon steel with a slot at the armature end. Copper shading rings eliminate chatter.



Coils are wound with special heavy insulated wire which avoids the possibility of short circuited turns. Coils are impregnated to insure quiet operation.



# CLARE RELAYS

"Custom-Built" Multiple Contact Relays for Electrical, Electronic and Industrial Use

# PLASTIC PARTS

... PRODUCED TO YOUR SPECIFICATIONS

## PRINTING DIE CUTTING CEMENTING

Wide experience by all known processes in the application of printing, engraving, silk screening, die cutting and cementing of all thermoplastics.

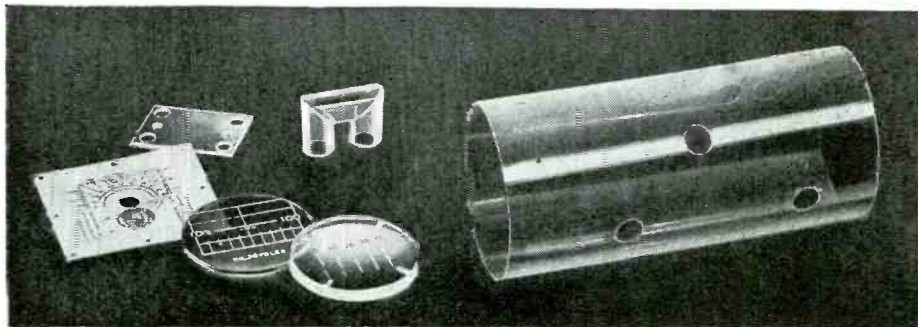

## FORMING

Specialists in deep drawing radio dial windows, embossing, swaging and bending in Acetate, Vinylite and Acrylics.

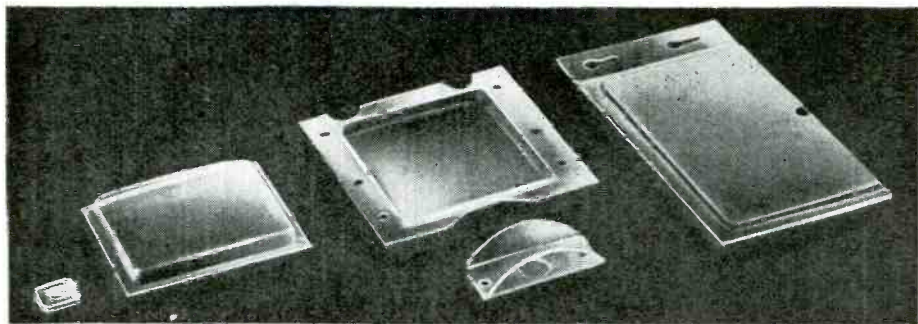

## MACHINING

Precision threading, screw machine, milling, drilling, turning of Polystyrene, Acrylics, Phenolics, Nylon, Tenite; sheets, tubes and rods; through spindle capacity up to 2½" rod.

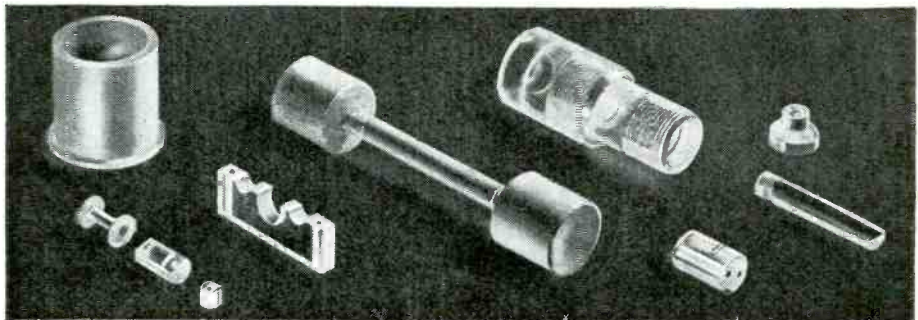

## ASSEMBLY

Our engineers can assist you in problems of design and assembly of your plastic units.

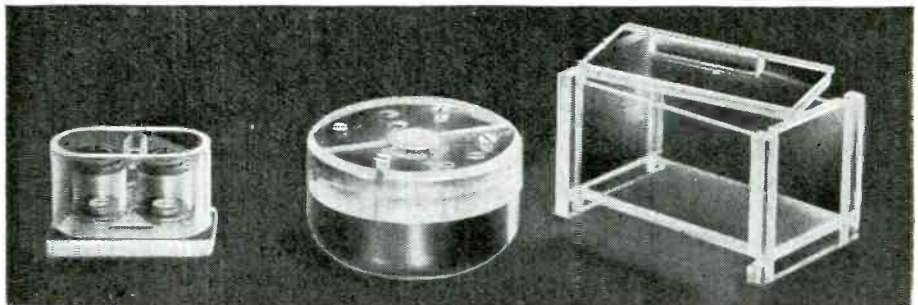

# PRINTLOID, Inc.

93 Mercer Street  
New York 12, N. Y.

**EASTERN AIR DEVICES presents**  
**2 NEW HIGHLY EFFICIENT BLOWERS**

**MODEL J57**  
**CENTRIFUGAL BLOWER**

**110 C.F.M. FREE AIR**

60 cycles • 115 volts • single phase capacitor start and run motor • 3300 R.P.M. • 4 mfd capacitor required • weight of unit 3 lbs. 10 oz. • overall width 5 1/2" • overall length 5 3/4".

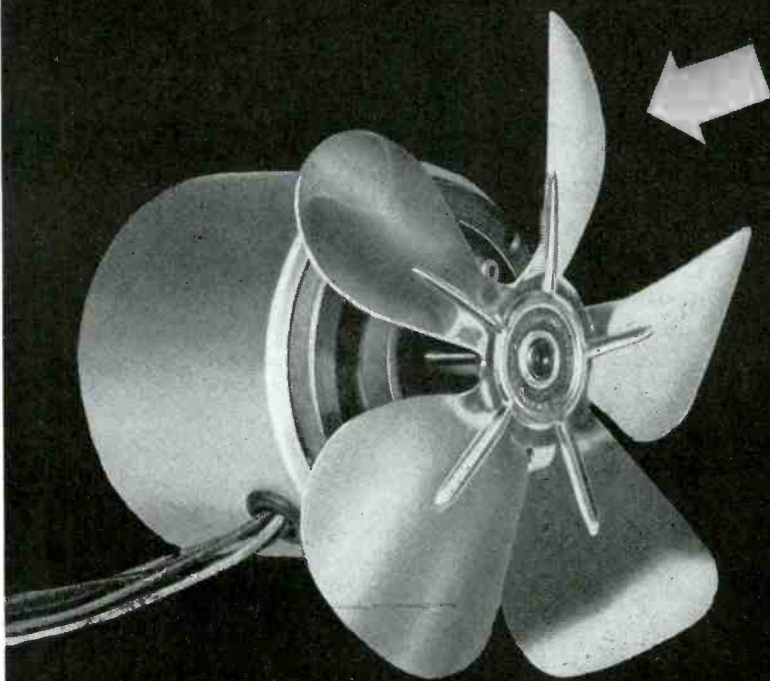
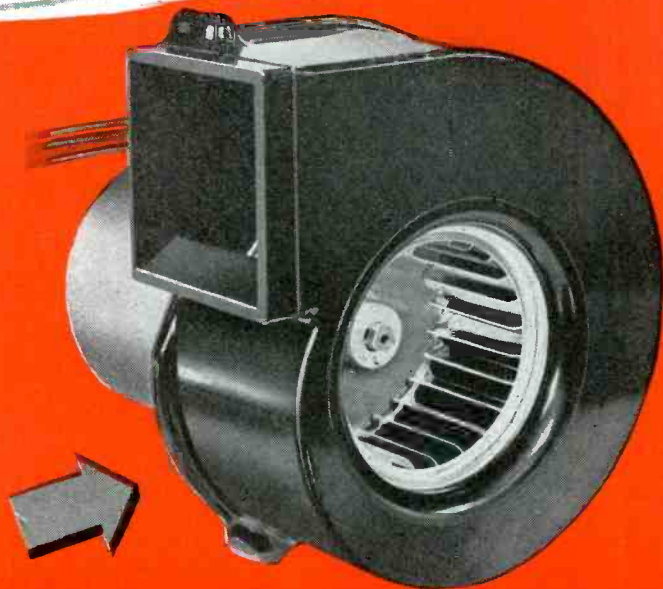

**MODEL J87**  
**AXIAL FLOW BLOWER**

**475 C.F.M. FREE AIR** (NEMA CODE)  
**175 C.F.M. FREE AIR** (NAFM CODE)

60 cycles • 115 volts • single phase capacitor start and run motor • 3300 R.P.M. • continuous duty • 25 watts input • 4 mfd condenser required • 87% power factor • weight of unit 3 lbs. 1 oz. • Fan: 5 blade propeller type, 5 1/2" diameter.

We invite inquiry!

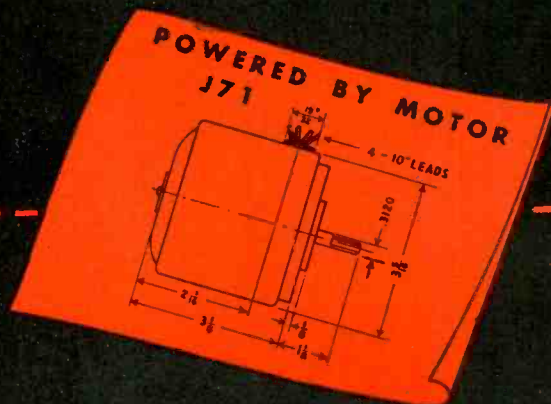

**EASTERN AIR DEVICES, INC.**

585 Dean Street • Brooklyn 17, N. Y.

An Affiliate of The Fred Goetz Co., Inc., Est. 1893

MANUFACTURERS OF CONTROL DEVICES AND COMPONENTS FOR ELECTRICAL, ELECTRONIC AND MECHANICAL APPLICATIONS

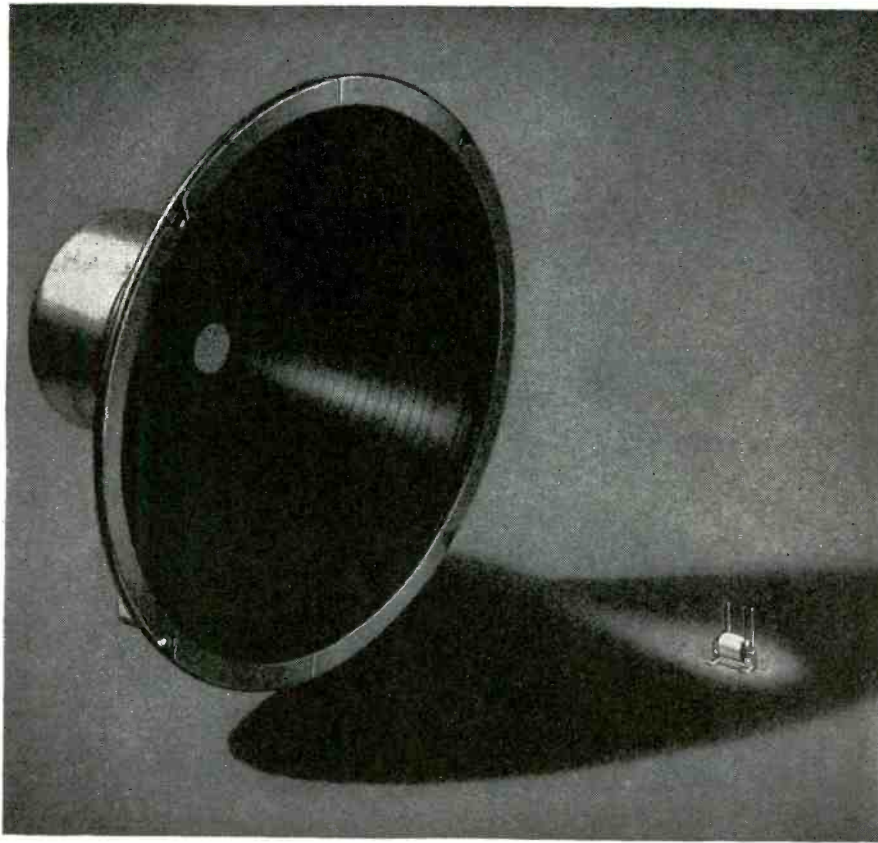

## Permoflux Speakers and Transformers Set New Standards of Comparison!

New Permoflux speakers in a complete range of true-dimensioned sizes from 2" to 15", with power handling capacities from 1 to 20 watts, provide the finest sound reproduction for every application.

Permoflux midget transformers, with their many practical circuit applications, have literally revolutionized efficiency concepts where size and weight are determining factors.

Advanced engineering designs, improved manufacturing methods and new materials have all contributed their share in the development of Permoflux speakers, transformers, microphones and headphones. You can count on Permoflux to provide an acoustical unit to suit your exacting requirements.

**BUY WAR BONDS FOR VICTORY!**

TRADE MARK  
**PERMO-FLUX**  
 PERMOFLUX CORPORATION  
 4900 WEST GRAND AVE., CHICAGO 39, ILL.



PIONEER MANUFACTURERS OF PERMANENT MAGNET DYNAMIC TRANSDUCERS

## RADIO DOOR ACTUATOR

(Continued from page 130)

that just before the war automobile prices were often quoted complete with radio receiver. This trend clearly indicates that automobiles without radio receivers will become, in the future, the exception rather than the rule; even as present-day automobiles without headlights would be the exception. It seems fair, then, to consider the additional expense, incurred in modifying standard equipment automobile receivers for induction remote control transmission, as the real cost of such transmitters.

The frequency and power dictates indicate that possibly existing audio components could be used and Fig. 2 illustrates one practical modification using the audio section of a conventional receiver to generate the desired power at frequencies of from 10 to 20 kilocycles. In the illustration the ganged selector switch is shown in the "receive" position, enabling the normal aural reception of broadcast signals. In the "transmit" position a low impedance loop antenna shunted by a series resonant LC circuit is substituted for the audio reproducer and the normal amplifier input voltage is replaced by a regenerative feedback voltage from the resonant circuit.

The audio amplifier oscillates at a frequency determined roughly by the constants of the LC circuit and may be tuned over reasonably wide limits by variable capacitor C. It may be desirable to employ an RC combination in place of the LC circuit to introduce waveform distortion in the loop current. Certain non-sinusoidal waveforms effectively increase the control radius of the transmitter, while retaining the same average power input to the amplifier. Fig. 3 shows one type of loop antenna supported from the frame of a 1940 Ford V-8 automobile and also illustrates the fact that the plane of the loop is sufficiently high to be well protected.

A Philco Model No. 1740 Ford automobile receiver has been altered, according to the outlined plan, as illustrated in Fig. 4. It was found necessary to provide another section on the ganged selector switch to eliminate the shunting effects of the high frequency by-pass capacitors when transmitting. Further, it was found desirable to remove the rf filter condenser from the 7B6 plate circuit and relocate it in the grid circuit ahead of the selector switch. The receiver escutcheon is illustrated in Fig. 5, showing the location of the "Garage Door" pushbutton.

With a one-foot radius receiving loop buried in the center of the ap-

(Continued on page 138)



# WHILE

*your new product is still*

**a gleam in your eye**

# THEN

*discuss the springs you'll  
need with Accurate*

**it's a good way to save  
time, trouble and money**

● Often, when we know all the influencing factors—when we know how and why and where you are going to use springs—we can make helpful suggestions. These suggestions may improve your product, shorten assembly time, increase spring efficiency and perhaps cut spring costs.

We don't say we can work miracles. But . . . the efficient use and application of spring power is our business just as well as is their manufacture. In planning your future products, ask us about the springs *before* you start manufacturing—in confidence, of course. It costs you nothing . . . and may pay you well.

**ACCURATE SPRING MANUFACTURING CO.**  
3808 West Lake Street Chicago 24, Illinois



**SPRINGS  
WIRE FORMS  
STAMPINGS**

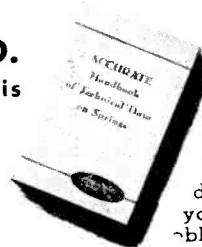

● Send for your copy of the new Accurate Spring Handbook. It's full of data and formulae which you will find useful. No obligation.

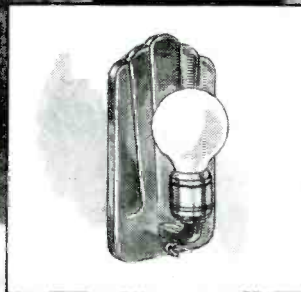

more efficient  
... in miniature



ACTUAL SIZE

To clean and generally maintain the bulky, smelly oil lamp was a daily chore. In contrast, the compact incandescent lamp that gives many times the light, requires no maintenance except a rare and easily installed replacement. Its operation is safe and simple.

Just as the incandescent lamp opened up new avenues for more efficient lighting, so the miniature electronic tube presents new possibilities in the science of electronics. More compact sets — greater durability because of small rugged parts and better performance when used in high frequency circuits, are advantages of using Tung-Sol Miniature Tubes.

Manufacturers of radio sets and other electronic devices are invited to study the advisability of using miniatures in their new equipment. Tung-Sol Engineers would be glad to aid them in designing circuits and selecting tubes. All plans that are disclosed in consultation are held in strictest confidence.

# TUNG-SOL

*vibration-tested*

**ELECTRONIC TUBES**

**TUNG-SOL LAMP WORKS INC., NEWARK 4, NEW JERSEY**

*Also Manufacturers of Miniature Incandescent Lamps, All-Glass Sealed Beam Headlight Lamps and Current Intermittors*



# A WISE TREND

A few years ago plugs and jacks were uncommon except for a few applications in radio and test equipment. Today the trend to greater use of plugs and jacks is fast becoming standard practice in radio and electronic industries.

Keeping up with this trend, Johnson has designed many new plugs to meet industries special requirements, as well as supplying standard plugs which are being used in an increasing number of new applications.

The use of plugs on components is growing more popular, speeding production, facilitating easy replacement and interchanging of parts.

Plug and jack assemblies make it possible to remove sections of equipment for repair and maintenance without disturbing the wiring, and in police, fire, railroad and similar installation, units which fail may be quickly replaced with little delay in operation.

Let Johnson, a pioneer in the manufacture of plugs and jacks, supply you with a plug and jack combination or assembly to meet your requirements.

Send us your problem.

Ask for catalog 968-O



# JOHNSON

*a famous name in Radio*

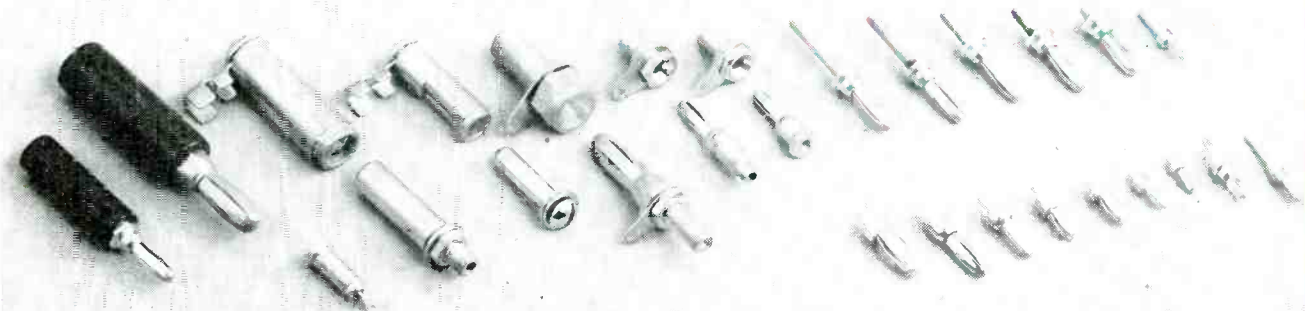

# PORTABLE POWER PROBLEMS

THIS MONTH—ILG MOTOR TEMPERATURE TEST



**BURGESS INDUSTRIAL BATTERIES** power ohmmeters to determine temperature rise in fan motors manufactured by Ilg Electric Ventilating Company. Thousands of industries using test and control equipment rely on Burgess Batteries for dependable service. Your local Burgess distributor can fill your needs from the line designed to meet industrial battery requirements. For full information on the *complete line* of dry batteries write for the name and address of your nearest Burgess distributor now.

**2 OUT OF 3 SELECTED BURGESS BATTERIES** as their *first choice* in a recent nation-wide survey of manufacturer electronic engineers. If you require a special battery for a new application, Burgess engineers can solve your problem with the right battery type. *Burgess Battery Company, Freeport, Ill.*

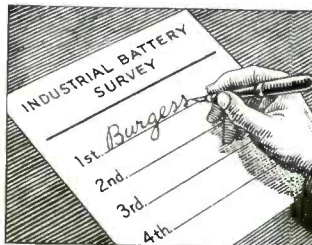

# BURGESS BATTERIES

LOOSE TALK IS STILL DANGEROUS!

Recognized as the **MOST COMPLETE LINE** of dry batteries

## RADIO DOOR ACTUATOR

(Continued from page 134)

proach driveway, the present system permits control of the doors and garage lights for a distance of some seven or eight feet, which is more than adequate for the intended purpose. Initial experiments using capacitive rather than inductive coupling wherein the "whip" type automobile receiving antenna is used also for transmission, have indicated the feasibility of this method. Such apparatus is not stressed, however, because of the detuning of the high impedance antenna systems during snow, sleet and rain storms which results in uncertain operation at times when the remote control of the garage doors is most desirable.

The disclosed apparatus requires that the automobile receiver be in operation at the instant remote control is desired. The use of instant-heating tubes within the feedback loop and either an instant-heating or cold cathode high voltage rectifier tube along with adequate switching will obviate this potential disadvantage.

The receiver manufacturer will be able to supply the modified receiver complete with adequately labelled selector switch and output terminals for induction remote control at an attractive market price. In fact, with an appropriate sales campaign, the receiver so equipped will have a definite sales advantage over standard receivers. The induction loop antenna and attendant remotely controlled apparatus may be added at the discretion of the ultimate consumer.

## PHASE SHIFT EFFECT

(Continued from page 100)

diagram. Fig. 12 gives the related amplification characteristics. These circuits may be useful in applications where the phase shift is to be kept constant and the amplification is of minor importance.

The curves for a three-stage amplifier were experimentally tested by the method described before for the flat amplification, curves a, and the flat phase shift, curves b, in Figs. 13 and 14. Satisfactory agreement between computed and measured values is observed.

## PHONO HEAD BALANCE

(Continued from page 103)

5000 ohms output impedance so that the series connection provided a match to the impedance of the playback reproducer under test. For lower impedances a matching

(Continued on page 142)

IF YOU HAVE A "FITTINGS" PROBLEM



**AMPHENOL**

The comprehensive Amphenol line of "AN" Conduit Fittings is made to strict Army and Navy standards. Threads are accurately manufactured to specifications so that parts are completely interchangeable. Permalub coating on threads prevents binding of the coupled parts . . . obtainable in eleven finishes.

Amphenol Fittings have widespread uses in the radio, communications and electrical industries.

Amphenol Fittings are another precision made unit in the complete Amphenol line of U.H.F. Cables and Connectors, Conduit, Connectors (A-N., U.H.F. British), Cable Assemblies, Radio Parts and Plastics for Industry.

*Amphenol Condensed Catalog number 72 is now ready . . . write for your copy today.*

Depend upon Amphenol Quality.

**AMERICAN PHENOLIC CORPORATION**

Chicago 50, Illinois

In Canada • Amphenol Limited • Toronto



# TOUGH JOBS WANTED



Final operation in assembly of a 110-volt radio control unit. Metal and plastic parts made by Remler.



## Telephone Type Plugs

### Signal Corps • Navy Specifications

PLUG NUMBER	NUMBER CONTACTS	TYPE SLEEVE	SEE NOTE
PL47	2	Long	
PL54	2	Short	1
PL55	2	Long	2
PL55K	2	Shoulder	
PL68	3	Long	3
PL124	2	Short	1
PL125	2	Long	2
PL155	2	Off Set	2
PL354	2	Short	1
PL540	2	Short	1
B-180207	2	(Lock-Nut)	2
CAU-49109	2	Long	2
CRL-49007A	3	Long	3
NAF-1136-1	2	Long	2
NAF-212938-1	3	Long	3
NAF-215285-2	2	Short	1

Note 1 — Interchangeable with others Note 1.  
 Note 2 — Interchangeable with others Note 2.  
 Note 3 — Interchangeable with others Note 3.

**OTHER DESIGNS TO ORDER**

**FOR TWENTY-SEVEN YEARS** Remler has been favorably known as an electronic engineering organization composed of a closely knit group of specialists, qualified by training and experience to produce radio, electronic components and complete sound equipment • In the near future Remler facilities will again be available for the mass production of electronic components in metal and plastics and the custom production of radio, sound transmitting and amplifying equipment.

*Inquiries invited, write—*

**REMLER COMPANY, LTD. • 2101 Bryant St. • San Francisco, 10, Calif.**

# REMLER

SINCE 1918

*Announcing & Communication Equipment*

# Step Up THE ACCURACY OF YOUR OPERATING EQUIPMENT

with

# Raytheon Voltage Stabilizers

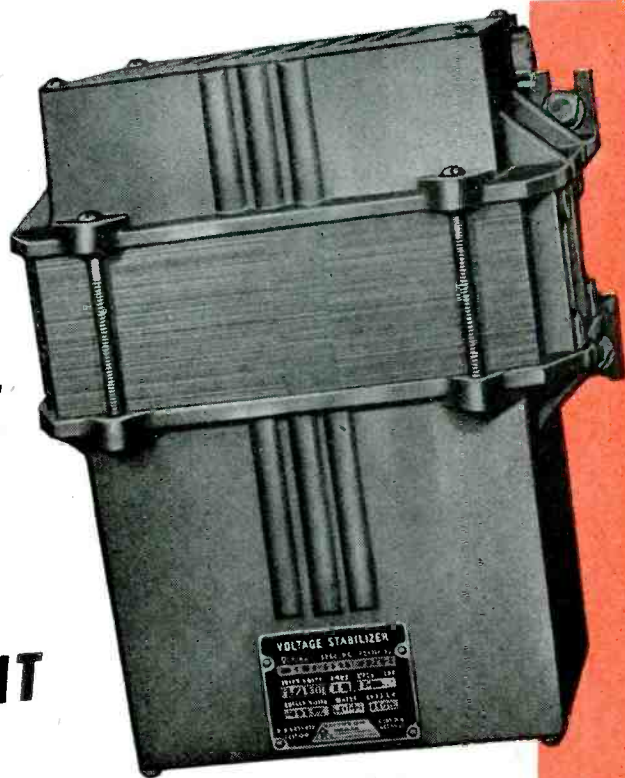

LINE VOLTAGE may vary between 95 and 130 volts. If not stabilized at the input side of your equipment, this variation can cause highly inaccurate performance.

Get a close-up of the kind of performance your equipment can deliver when teamed with a magnetic-type Raytheon Voltage Stabilizer. Inquire now.

Raytheon Voltage Stabilizers are at work in such varied fields as:

RADIO • TELEVISION • COMMUNICATIONS • RADAR •  
MOTION PICTURES • SOUND RECORDING • ELECTRONIC  
DEVICES • CONSTANT SPEED MOTORS • PRODUCTION  
MACHINERY • SIGNAL SYSTEMS • X-RAY EQUIPMENT  
TESTING AND LABORATORY EQUIPMENT

Write today for Stabilizer Bulletin DL48-537.  
Get the story complete.

- ★ Control of output voltage to within  $\pm 1/2\%$ .
- ★ Stabilization at any load within rated capacities from 95-130 V.
- ★ Quick response. Stabilizes varying input voltage within 1/20 second.
- ★ Entirely automatic. No moving parts. No maintenance. No adjustments.
- ★ Won't overheat. Temperature rise is within 55° C.

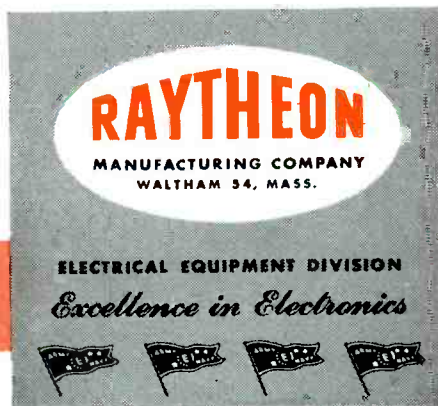

it won't  
be long  
**NOW**

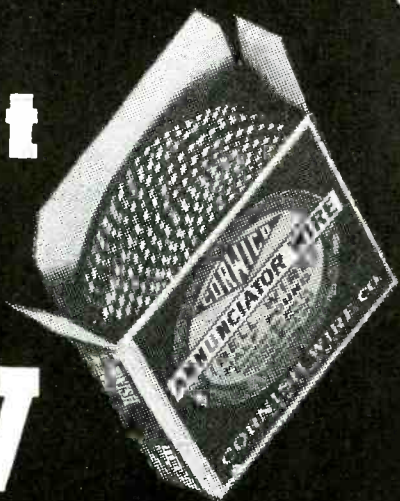

We are busy as ever, producing scientific communications wire for our Armed Forces . . . concentrating upon **VICTORY!** However, things are looking up. Soon, we hope, you'll be able to gaze **possessively** upon these familiar **CORWICO** units, and put them to work once more on civilian jobs.



**cornish**  
WIRE COMPANY, INC.

15 Park Row, New York City, New York

"Made by Engineers for Engineers"

## PHONO HEAD BALANCE

(Continued from page 138)

transformer is required. The mixing may also be accomplished by applying the two oscillator outputs respectively to the grids of a suitable dual triode and providing by this means an electronic mixing. The resultant signal will still appear as in the picture 7A.

A high pass filter is inserted between the reproducer or recorder under test and the vertical plates of an oscilloscope. This filter cuts off below two hundred cycles. The effectiveness of its action is observed by shorting out the head under test and viewing the result on the 'scope. Fig. 7E is a photo of the same signal as 7A when observed at the output of the filter.

The two oscillators are set at 20 cycles per second and at 500 cycles per second. The output of the 20 cycle oscillator is fed to the horizontal synchronization input of the oscilloscope and the sweep circuits of the 'scope adjusted to produce 1 cycle of the 20 cycle signal on the screen.

It was found that with heads having a "single-ended" magnetic circuit, inductive effects reduced the amplitude of the changes to a low level so that less accurate adjustments could be made. To offset this effect, the motion of the stylus was isolated from the driving circuit by the use of the photoelectric system shown diagrammatically in Fig. 6. The high pass filter was inserted in the output of the photoelectric amplifier. (Incidentally, this photoelectric system was later used as a means of frequency response checking. In this application the filter was removed and the output observed on a db meter.)

The adjustments of heads will depend upon their construction. Those tested by the writer had side adjusting screws which applied pressure to rubber damping blocks at the armature. Adjustment was accomplished by variation of the compression of these blocks. Figs. 8A, 8B, and 8C illustrate improper conditions resulting from various degrees of unbalanced adjustment. A perfectly balanced adjustment would produce a pattern similar to that of Fig. 7D, except that the two troughs would be of exactly equal depth.

## GAGING BY THE BLIND

(Continued from page 104)

operator was required to wear an earphone through which he heard a dot and a dash (Morse code letter "A") if the article was too small. If the article was too large he heard the reverse or a dash and a dot (Morse for "N"). If the article was passable he heard both signals and

(Continued on page 146)



# Federal... **KNOWS H-F Cable**

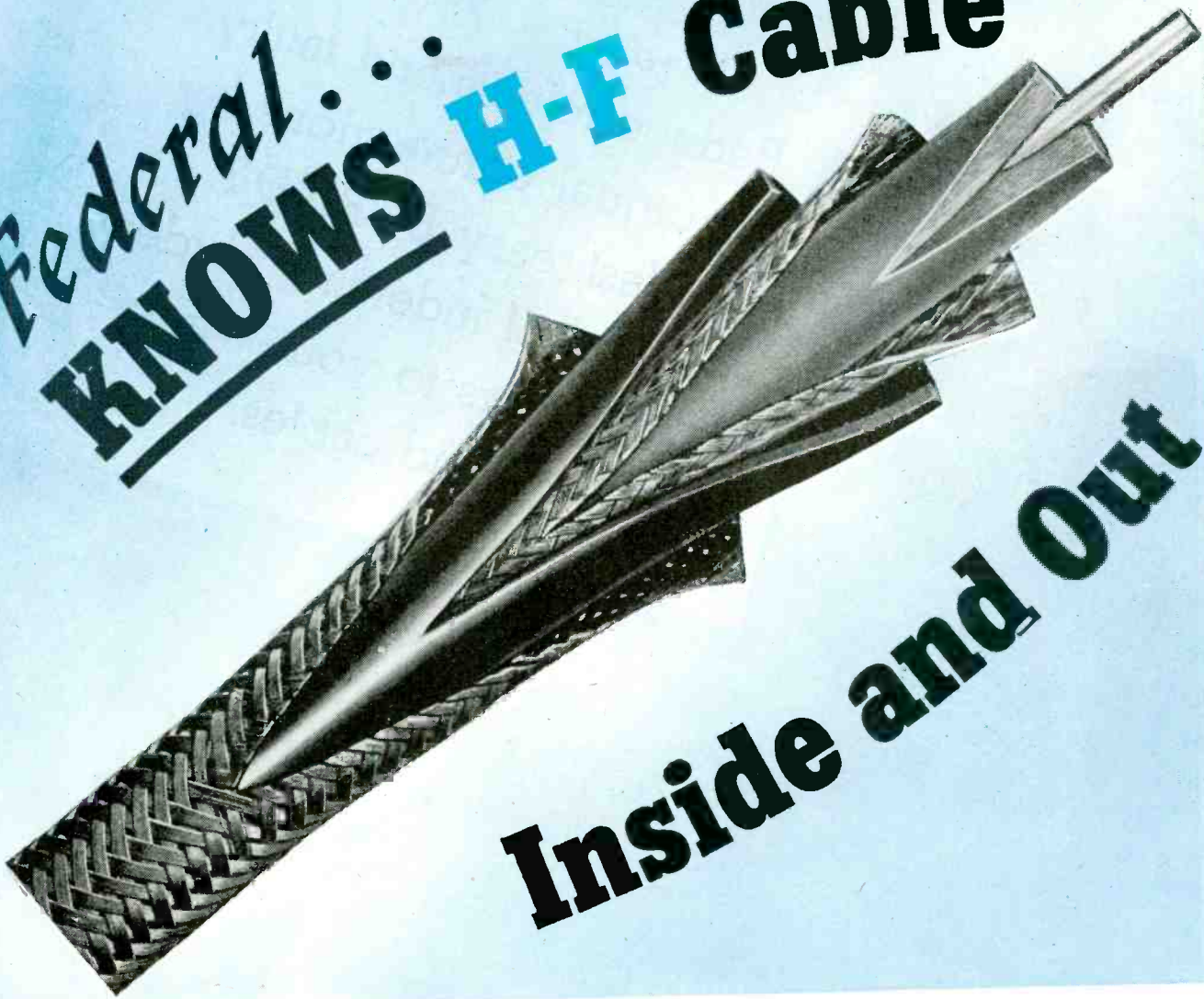

## **Inside and Out**

From inner conductor to outer covering . . . Federal really knows high-frequency transmission lines.

And this knowledge was not easily won. As the pioneer in the field Federal not only developed over 80% of all h-f cable types in use today . . . but developed most of the equipment needed to test them.

Attenuation, high-voltage, dielectric and balance testing equipment, velocity of propagation, braid-resistance and electri-

cal length meters . . . were all Federal-engineered to fit specific requirements.

That's why it's logical to turn to the acknowledged leader in the field for the finest in h-f cables, specialty-engineered harnesses and cable assemblies.

Where requirements are critical . . . for transmission lines with special characteristics . . . for custom-built and engineered harnesses and cable assemblies . . . take your high-frequency transmission problems to Federal.



## *Federal Telephone and Radio Corporation*



Newark 1, N. J.

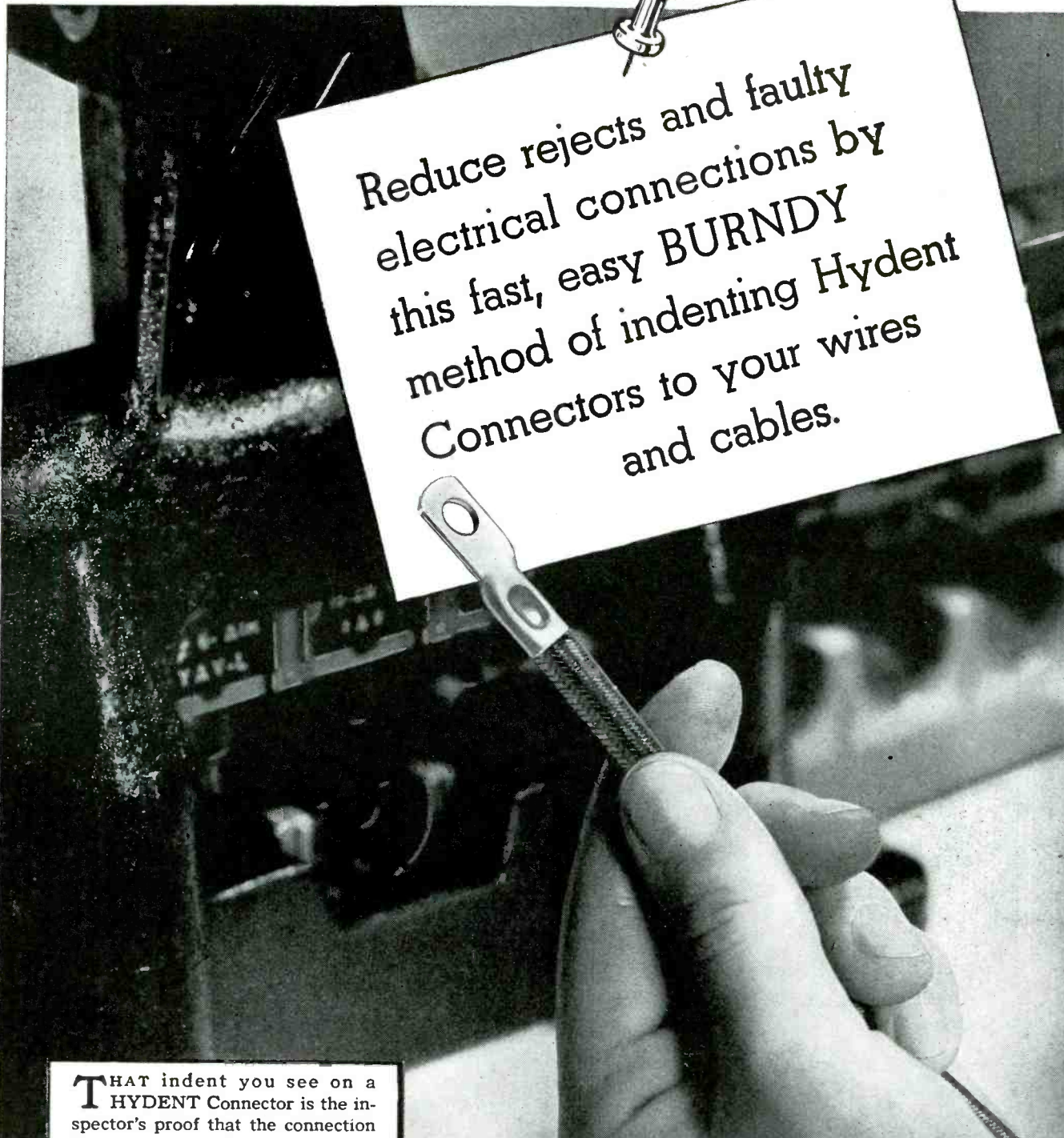

Reduce rejects and faulty electrical connections by this fast, easy BURNDY method of indenting Hydent Connectors to your wires and cables.

**T**HAT indent you see on a HYDENT Connector is the inspector's proof that the connection is sound electrically and mechanically. These connectors are of one-piece construction, and the depth of indent is accurately controlled by the automatic HYPRESS. In addition, the simplicity of attaching HYDENT Connectors cuts both time and cost as much as 50%. Operators can attach as many as 500 or more an hour. Connectors and indenting tools of the proper type and size are available to suit your production needs. Let us send you the details. Write Burndy Engineering Co., Inc., 107-K Bruckner Boulevard, New York 54, N. Y.

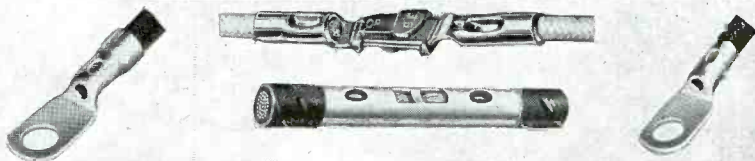

Headquarters for  
CONNECTORS

# Burndy



Dear P. J.

The other day, at the Leland Electric Co., I saw a very remarkable concentration of power in a 400 cycle alternator.

Think you had better investigate this before you go ahead with that project we were discussing recently.

Ed

*if it calls for*  
**CREATIVE ELECTRICAL  
ENGINEERING...**  
*call for Leland!*

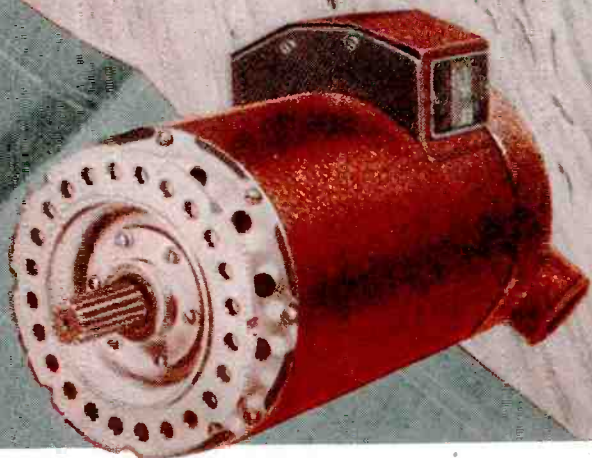

Motors, Generators, Motor Generators and Voltage Regulators



**THE Leland ELECTRIC COMPANY**

DAYTON, OHIO • IN CANADA, LELAND ELECTRIC CANADA, LTD. ... GUELPHI, ONTARIO

ONE QUICK CENTRAL SOURCE  
for all Leading Makes of  
**TRANSFORMERS**

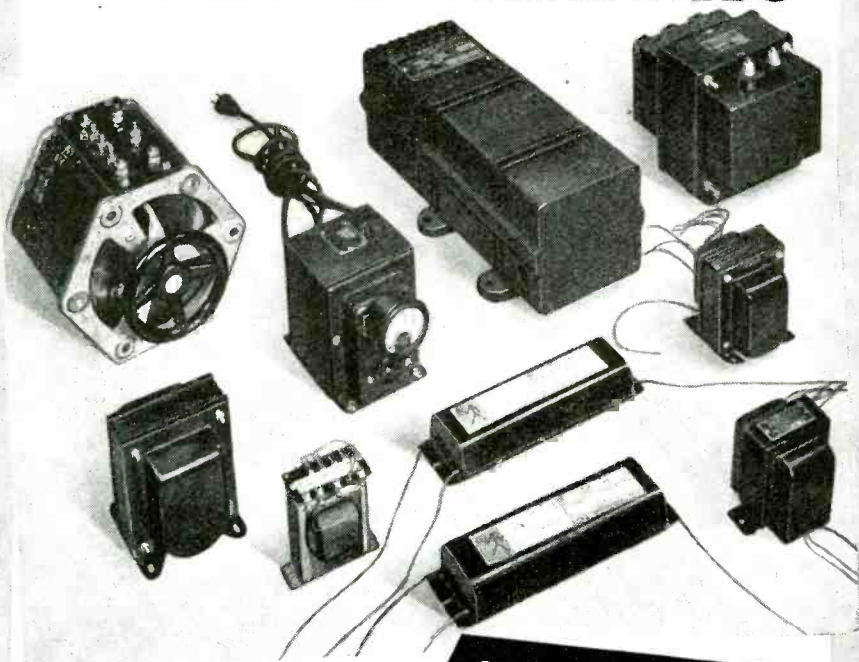

**STOCK ON HAND FOR  
IMMEDIATE DELIVERY**

Thordarson  
Stancor  
Sola  
General Radio  
UTC  
Superior  
Merit Coil  
Knight  
General  
Transformer  
Acme  
Pioneer Electric  
Crest

It's simpler, faster to get your transformer needs from this one central source. Here, under one roof, are all the leading makes, in all the wanted types:

Power • Adjustable • Voltage Regulating  
Step-up and Step-down • Plate and Filament  
Audio Input • Interstage and Output • Modulation  
Driver • Microphone, Line and Mixing Transformers  
Filter and Swinging Chokes • Audio Reactors  
Fluorescent Lighting Ballasts

Large and varied stocks are maintained for *rush service*. Close contact with manufacturers expedites procurement. This complete service saves time and work. That's why thousands call ALLIED First!

WRITE, WIRE, OR PHONE HAYMARKET 6800  
for Everything in Radio and Electronics

Helpful  
**BUYING  
GUIDE**  
Available  
on Request  
Write for it!

**ALLIED RADIO**

CORPORATION

833 W. Jackson Blvd. • Dept. 32-J-5 • Chicago 7, Illinois

SUPPLIERS OF ELECTRONIC PARTS AND EQUIPMENT TO INDUSTRIAL AMERICA

Electronic Tubes, Rectifiers, Power Supplies, Intercommunicating Systems, Sound Systems, Photo-Cell Equipment, Batteries, Chargers, Converters, Generators, Supplies for Resistance Welders, Fuses, Test Instruments, Meters, Broadcast Station Equipment, Relays, Condensers, Capacitors, Resistors, Rheostats, Transformers, Switches, Coaxial Cable, Wire, Soldering Irons, Microphones, Speakers, Technical Books, etc.

**GAGING BY THE BLIND**

(Continued from page 142)

they joined to produce a continuous tone. But in this instance, minute high and low spots in the surface of the article interfered with the transmission of the "A" and "N" signals and the gage had to be abandoned.

The third gage was also an electronic one with the indicator continuously sounding at a high, low, and normal pitch into earphones. After a few days, the experimental operator objected to the constant sound. To overcome this, a photo-electric cell was installed which cast a beam of light across the gage block (on which the piece being gaged is placed) so that when no work was in the gage the sound was cut off. But again the operator objected because the earphones deprived him of any outside sound, making him feel closed-in and helpless.

The fourth gage was a further development of the third. An additional amplifier tube was placed in the electronic system to facilitate the operation of a loud-speaker, which was fixed on the back of the operator's chair above his head. The sound system operated on the same principle as before, except that the sounds were amplified rather than transmitted through earphones. This model met with the operator's complete satisfaction.

A visual gage was then added to the sound one, to facilitate the work of the set-up man, and, since the device was becoming too complicated, the photo-electric cell was also eliminated by the addition of a microswitch to the back-stop of the gage so that the sound would be heard only when work was being gaged. This final model proved satisfactory to the operator and the lineman and is the one now in operation.

The circuit diagram shows the electron coupled audio oscillator circuit used in this device. Actuation of the relays CR1 or CR2 by the gaging head contacts shunts the primary of a matching transformer with varying amounts of capacity to form 3 LC circuits of different frequencies.

**NEW PATENTS**

(Continued from page 146)

According to the invention the segments 27 and 29 form an integral part of a hollow, metallic, toroidal cavity constituting the resonant tank circuit. The toroidal cavity is located inside the tube avoiding the necessity for leads to an external resonant circuit and reducing undesired capacitances so that a high frequency output can be obtained.

The cavity has a circumferential slot and the segments 27 and 29 are extensions of the opposing edges of this slot, respectively. If electrons impinge alternately against the

(Continued on page 150)

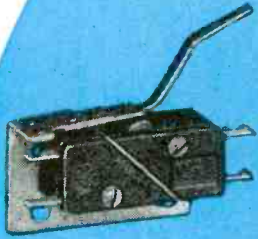

A leaf actuator makes this Switchette into a tiny limit switch.

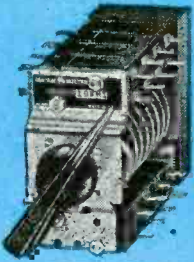

Selector switches made up of Switchettes provide compact, sequence circuit control.



This small but sturdy limit switch has widespread application. The Switchette is actuated by a plunger.



In this compact multicircuit switch, Switchettes save space and weight.

# KEY TO COMPACT DESIGN

**Y**OU can use Switchettes to control several circuits from a single location. They can be actuated by cams in selector switches, or by a bellows or lever in limit switches. Whichever way you use them, G-E Switchettes help you save space and make your equipment more compact.

Note the dimensions:  $1\frac{1}{4}$  by  $\frac{1}{2}$  by  $\frac{1}{2}$  inch. Yet the Switchette handles up to 10 amperes at 24 volts d-c (230 volts a-c), and is sturdy enough to withstand millions of mechanical operations.

Its small size, its lightning-fast snap action, and its ability to resist high physical shock and vibration make it ideal for built-in applications on electric control equipment

that has to "take it." Best of all, because of its unusual double-break contact structure, it simplifies the solution of many tricky circuit-control problems.

### *Don't handicap your important designs*

Your plans for a smaller, lighter, or more compact equipment need not be stymied by the lack of a suitable make-and-break contact mechanism. More than 200 modifications of the Switchette are ready to meet your needs. In addition, we have a variety of limit switches, transfer and selector switches, push-button stations, thermostats and timers built around the Switchette. Perhaps you can use some of these

ready-made devices to advantage.

### *Send for a catalog*

If you don't already have a copy of our Switchette catalog, mail the coupon below. If none of the forms listed in the catalog meet your needs, our engineers will be glad to work with you to adapt them. *General Electric Co., Schenectady 5, New York.*

General Electric Company, Section B676-142  
Schenectady 5, New York

Please send me Bulletin GEA-3818, which gives detailed information on Switchettes.

NAME .....

COMPANY .....

ADDRESS .....

.....

# GENERAL ELECTRIC



# SYLVANIA NEWS

ELECTRONIC EQUIPMENT EDITION

SEPT.

Published by SYLVANIA ELECTRIC PRODUCTS INC., Emporium, Pa.

1945

## UNIVERSAL TEST UNIT CHECKS RADIO TUBES —ELECTRONIC DEVICES

Another essential electronic apparatus manufactured by the Industrial Apparatus Division of Sylvania Electric at Williamsport, Pa., is shown in accompanying photographs.

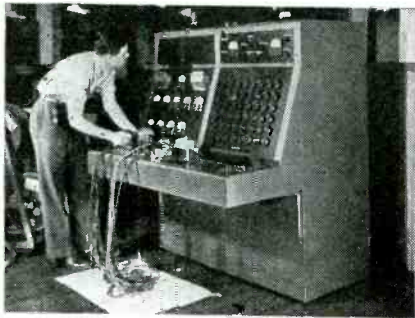

Above is the front view of the Universal Test Unit that preheats all tubes except rectifier, short tests all tubes (each element separately), noise tests RF and AF tests, static tests all tubes for all characteristics except plate resistance and amplification factor, dynamic tests mutual conductance, gain and power output at 400 cycles.

In addition, it may be adapted to test many other types of electronic devices by simply changing a small socket adaptor, and can be equipped with automatic tappers for short and noise tests.

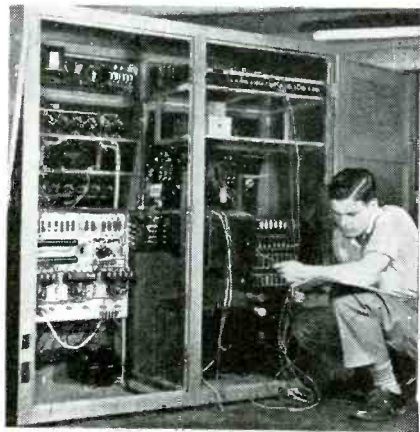

Rear view Universal Test Unit

## HIGH FREQUENCY TUBE ALSO BEST FOR ALL RADIOS

### *“Lock-In” Not Only Ideal For FM, Television, But Better For Other Type Sets*

An outstanding advantage of Sylvania Electric's advanced type radio tube—the Lock-In—is its perfect suitability for *any* class radio set—portable battery, farm battery, household, automobile, marine or aircraft.

#### Not Limited In Use

Although the basic electrical and mechanical advantages of the Lock-In construction are right in step with the continuing trend of the industry toward higher frequencies, these exceptional qualities do not limit the tube's applicability.

#### Set Performance Improved

On the contrary, this superiority is reflected in the better performance attained in all sets employing Sylvania Lock-In Tubes.

Write today for further information. *Sylvania Electric Products Inc., Emporium, Pa.*

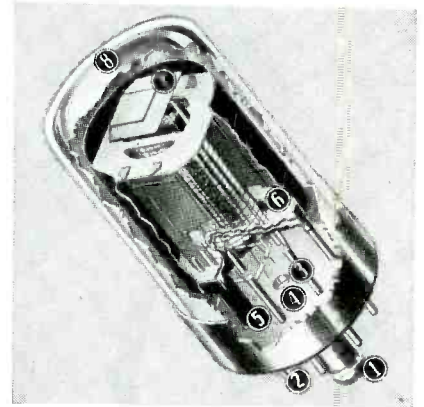

#### 9 POINTS OF MERIT

- 1 Lock-In locating plug . . . also acts as shield between pins.
- 2 No soldered connections . . . all welded for greater durability.
- 3 Short, direct connections . . . fewer welded joints — less loss.
- 4 All-glass header . . . better spacing of lead wires.
- 5 No glass flare . . . unobstructed space for internal shielding.
- 6 Improved mount support . . . ruggedly mounted on all sides.
- 7 Getter located on top . . . shorts eliminated by separation of getter material from leads.
- 8 No top cap connection . . . overhead wires eliminated.
- 9 Reduced overall height . . . space saving.

#### REMEMBER THIS EMBLEM



IT STANDS FOR  
HONORABLE  
SERVICE TO  
OUR COUNTRY

# SYLVANIA ELECTRIC

Emporium, Pa.

MAKERS OF RADIO TUBES; CATHODE RAY TUBES; ELECTRONIC DEVICES; FLUORESCENT LAMPS, FIXTURES, WIRING DEVICES; ELECTRIC LIGHT BULBS

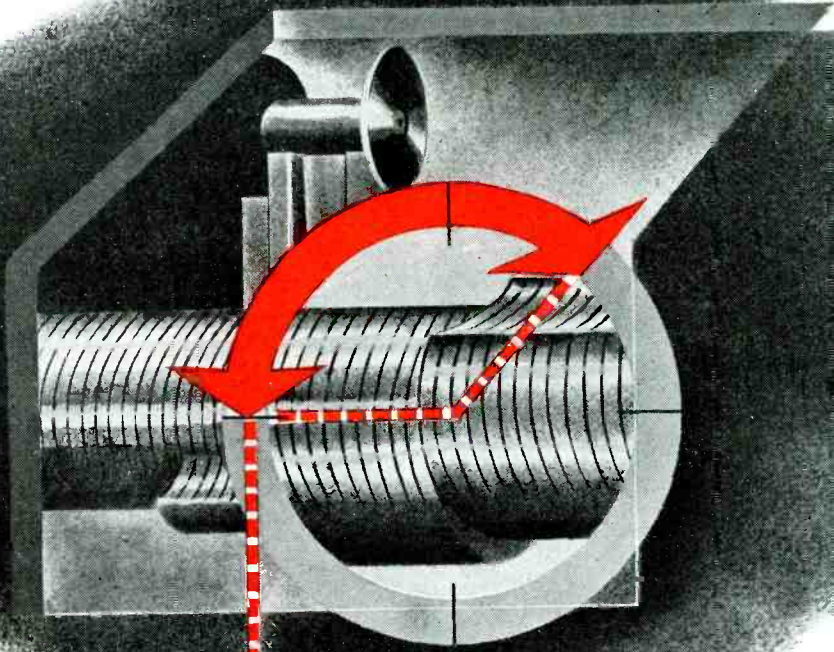

## Eliminating "idle time" **UPPED PRODUCTION 30%**

On cylinder heads for radial aircraft engines, dozens of cooling fins are required. To handle this intricate cutting job automatically, a machine tool manufacturer designed a special fin-milling machine using conventional constant-speed drive to rotate the cylinder head.

But preliminary tests showed that, because of the varying depths of the cuts, production could be increased if an adjustable-speed drive was applied to rotate the workpiece. Due to irregular shape of the workpiece, the milling cutter was usually under light load. At certain points in the cycle, it was out of contact with the metal altogether.

Westinghouse engineers were called in for consultation. Their recommendation: application of the

Mot-o-trol — an electronic adjustable-speed drive with accurate load control characteristics. Through its application, rotating speed of the workpiece is greatly increased over the light-load sections—thus eliminating "idle time". Full load is maintained on the cutter regardless of the contour being cut. By these improvements, *production was stepped up as much as 30%*.

This is typical of the modernizing possibilities with electronic equipment in countless industrial tasks. Your nearest Westinghouse office is ready now to supply helpful assistance and information on electronic applications for your industry. Westinghouse Electric Corporation, P. O. Box 868, Pittsburgh 30, Pennsylvania.

J-91088

### ELECTRONIC MOTOR CONTROL

The Westinghouse Mot-o-trol . . . employing Thyatron tubes to convert a-c to d-c . . . provides wide-range stepless speed control through a 20 to 1 range, from an a-c power source. Push-button control station enables operator to start, stop and control the speed while the machine is running. At any speed setting, variations in load cause little or no change in speed.

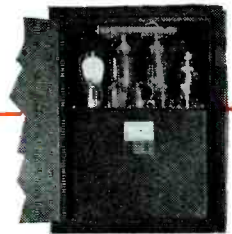

**Westinghouse**  
PLANTS IN 25 CITIES . . . OFFICES EVERYWHERE

*Electronics at Work*

ELECTRONIC EQUIPMENT FOR INDUSTRY AND HOME . . . ELECTRONIC TUBES . . . RADIO AND TELEVISION

# NEW VACUUM TUBE FREQUENCY METER...



Model 39-VTF, Series A, showing simplicity and portability.

... FOR FREQUENCIES IN 400 800 1200 1600 2400 3600 CYCLE BANDS

MODEL 39-VTF, Series A, a new development of J-B-T engineers, measures frequencies in six specific bands with accuracy of  $\pm 0.25\%$  of the frequency being measured, and with sufficient amplitude to be easily read.

Vacuum tube multivibrator circuits divide the incoming frequency by 1, 2, 3, 4, 6 or 9, depending on the position of the multiplier switch, and show the result on the time-tested, standard 400 cycle meter.

Regular line current is used for power supply, permitting an input sensitivity of 500,000 ohms. Response is not affected by irregular wave form, nor by harmonic content of unknown frequencies of less than 10% or 15% ... and input control permits use from 100 to 350 volts.

The result is an instrument of high accuracy and high stability with permanent calibration ... especially useful for checking audio oscillators, frequency converters, radar equipment, and for standardizing less accurate frequency measuring units.

Manufactured under J-B-T and/or Triplet Patents and Patents Pending

## Check These Points

- **EXTREME ACCURACY** ... within  $\pm 0.25\%$  of frequency being measured.
- **PERMANENT ACCURACY** ... no further calibration or standardization required at any time.
- **STABILITY** ... no temperature drift after initial 30 second warm-up.
- **BURN-OUT PROOF** ... no protection needed against accidental above-range frequencies.
- **SENSITIVITY** ... 500,000 ohms.
- **SIMPLICITY** ... uses standard tubes.
- **POSITIVE SWITCHING** ... built-in switch is J-B-T's own rugged, coin-silver plated instrument switch, as supplied for high quality testers.

**New Booklet** ... just off press, illustrates other types of J-B-T Vibrating Reed Frequency Meters. Ask for Bulletin VF-43-1C.



## NEW PATENTS

(Continued from page 146)

segments 27 and 29, high frequency currents will flow along the minor circumference of the cavity electrode, indicated by the dashed line. It is proposed to make the minor circumference of the cavity electrode approximately one-half wavelength of the desired output frequency, the cavity will then be resonant at that frequency.

A positive electrode is mounted behind the toroidal cavity to collect electrons passing the cavity and secondary electrons. The frequency generated is determined by the speed of the rotating beam, the number of segments and the cavity dimensions. In order to provide a larger number of commutator segments with a cavity of given size, the circumferential slot may be made in the outer major circumference of the toroid, the segments then extending radially outward from the toroid. In another alternative embodiment, the commutator segments are in the face of the toroidal cavity which is toward the beam, simplifying construction.

Amplitude modulation may be introduced by controlling the intensity of the electron beam for instance by applying the modulating voltage to a control grid in front of the deflecting electrodes.

C. A. Rosencrans, RCA, (F) March 30, 1940, (I) January 30, 1945, No. 2,368,328.

## High Frequency Generator

Further improvement of the beam-tube high frequency generator described in patent 62,368,328 is obtained by the insertion of conventional amplifier elements within the space of the toroidal cavity. The electron beam impinges on targets having a high secondary emission coefficient to increase the gain of the device. These targets are connected to the grids of the amplifier sections, the plates are connected to the protruding segments of the toroidal cavity.

C. A. Rosencrans, RCA, (F) October 31, 1940, (I) January 30, 1945, No. 2,368,329.

## Loop Antenna

The loop antenna comprises radiating arms 10, 11, 12 and 13 which are short compared to the operating wavelength and capacitatively coupled to form a closed loop. It is the object of the invention to adapt this type of antenna to operate efficiently over a wide frequency band. Subordinate transmission lines 18 connect two corners of the antenna to the feeding transmission line 20; they are so dimensioned as to transform the impedance at the coupling points to match the feeding line impedance.

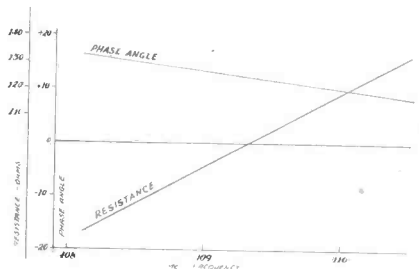

If arms 10, 11, 12 and 13 are each of the order of  $1/5$  of a wavelength at the mid-frequency, the impedance at the junction points of the arms may be 800 ohms and largely capacitive. The two branches of line 18 are also about  $1/5$  of a wavelength and if this line is designed to have a 400 ohm characteristic impedance, each of the branches of line 18 will serve as an impedance transformer transforming the capacitive impedance at the coupling points into a 200 ohm real impedance which will match a 100 ohm characteristic impedance of line 20.

(Continued on page 154)

# J-B-T INSTRUMENTS, INC.

433 CHAPEL STREET • NEW HAVEN 8, CONN.



# A NEW POST WAR **WEBSTER** RECORD CHANGER

## OF PROVED PERFORMANCE



Designed for post war use in the finest radio-phono combinations. Most outstanding development in a long list of Webster achievements—the new Webster Record Changer has more than passed rigid operating tests in the laboratory and field. In addition—it has been adapted to the needs of the armed services where it is now giving brilliant performance under the most exacting conditions. This, of course, is important to you—but equally important to you and your dealers are the many new features it possesses.

**THESE FEATURES WILL WIN DEALER AND PUBLIC ACCLAIM**



- ✓ Changes all standard 10 or 12 inch records; no chipping of record edge.
- ✓ Positive and fast change cycle—less time between records; automatic stop at end of play of last record.
- ✓ Light needle pressure. Freedom from noise and rumble—improved motor and drive—velocity trip.
- ✓ Highly styled; clean, beautiful liner.
- ✓ Compact—uses minimum space; ingenious mounting means.
- ✓ Many other important advantages.
- ✓ New post war design.

**WHIP THE NIP**  
BUY EXTRA  
WAR BONDS TODAY



**WRITE FOR  
INFORMATION**

**WEBSTER**



**CHICAGO**

3825 W. ARMITAGE AVENUE

CHICAGO 47, ILLINOIS

**31 YEARS OF CONTINUOUS SUCCESSFUL MANUFACTURING**



**"I SEE IT CLEARLY, GENTLEMEN... COILS... COILS... COILS  
... IT IS ALBION THAT CAN SHIP ALL YOU NEED."**

**SUPER-QUALITY COILS AT REASONABLE PRICES**

More and more every day, the industry is turning to Albion for fast, quality and quantity production of coils, chokes, and transformers. That's because here you benefit from the unbeatable combination of management "know how," skilled workmanship, streamlined facilities, and central location. Your requirements will be given prompt and thoughtful attention.

**ALBION  
COIL COMPANY**

ALBION, ILLINOIS

R. F. AND TRANSMITTING COILS AND CHOKES;  
I. F. TRANSFORMERS

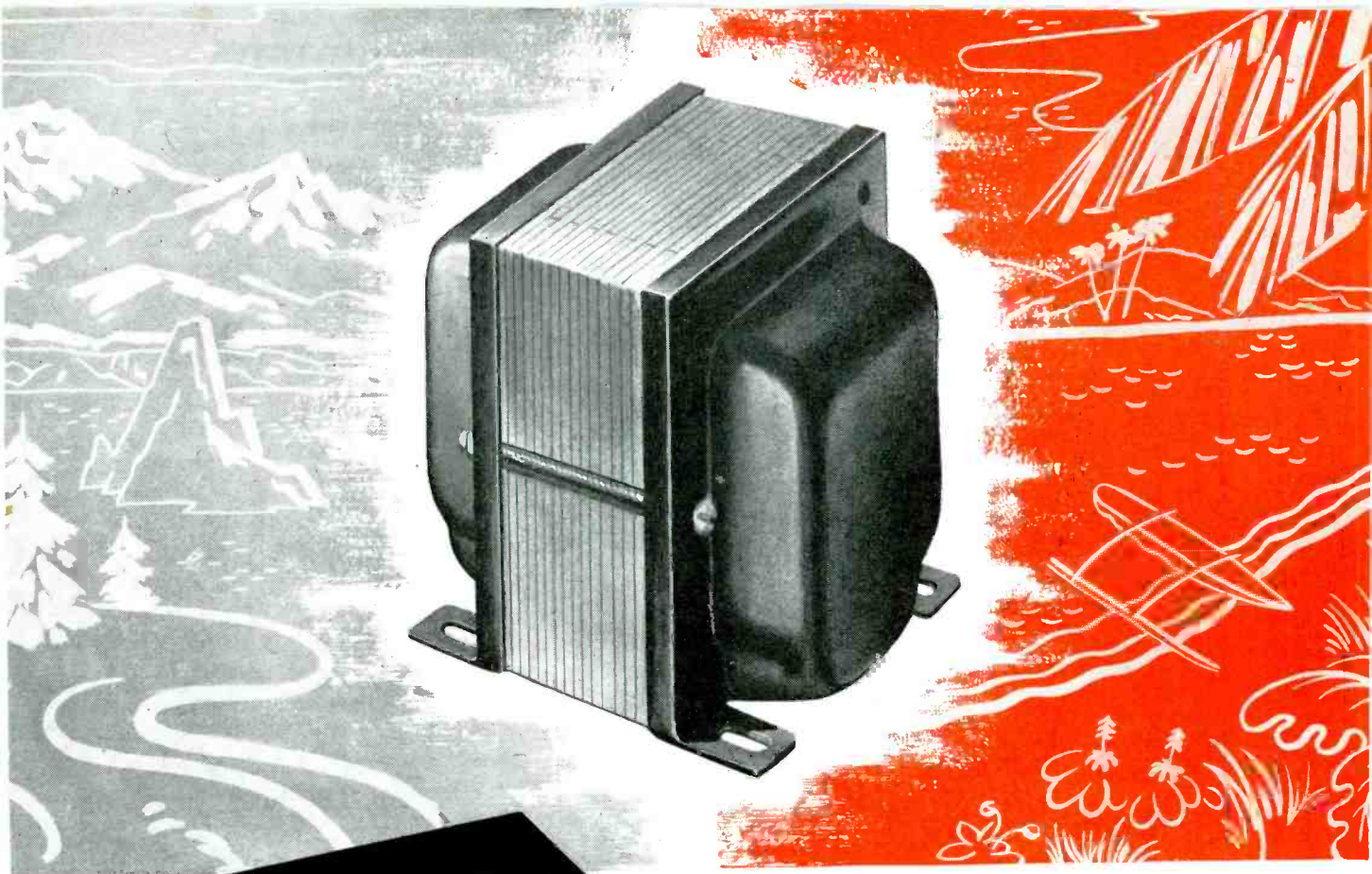

**under any  
conditions**

**Utah Transformers . . .  
guarantee trouble-free performance**

You know Utah's reputation for building a dependable line of transformers for replacement purposes in practically any radio set on the market. As soon as war production requirements permit, Utah will build the same dependable quality into a complete transformer line, not only for radio sets but for public address equipment...radio transmitting equipment...and hundreds of industrial uses as well.

- MOISTURE RESISTING
- CELLULOSE ACETATE INSULATION
- FINEST TRANSFORMER STEELS
- UTAH ENGINEERING

*Your assurance of trouble-free performance. Yet Utah transformers cost no more than ordinary transformers.*



**UTAH RADIO PRODUCTS COMPANY • 820 ORLEANS STREET • CHICAGO 10, ILLINOIS**

Utah Electronics (Canada) Ltd., 300 Chambly Road, Longueuil, Montreal (23) P. Q. • Ucoa Radio, S.A., Misiones 48, Buenos Aires.

# A Versatile Line

## *Customized*

### For Aeronautical Communications



#### Aeronautical Ground Stations

Since the very early days of airlines, Comco engineers have had actual field experience designing aeronautical ground station equipment. Transmitters available for operation on frequencies of 2 to 165 Mc. Receivers for frequencies of 2 to 8 Mc. and 100 to 165 Mc.

#### Airport Traffic Control Towers

Comco has pioneered, too, in producing airport control equipment. Transmitters for operation on 200 to 550 kc. and on 100 to 165 Mc.

Receivers for operation on 200 to 550 kc., 2 to 8 Mc. and 100 to 165 Mc.

#### Commercial and Private Aircraft

Dependable, compact equipment for all aircraft requirements. Transmitters for operation on frequencies of 2 to 8 Mc. and 100 to 165 Mc. Receivers from 200 to 1600 kc., 2 to 8 Mc. and 74 to 165 Mc.

\* \* \*

WRITE! Just a note on your company letterhead outlining your exact requirements. We'll give you the benefit of our specialized experience. We can supply a wide variety of customized equipment on priority NOW. We are accepting non-priority orders for post-war delivery.

MANUFACTURERS OF RADIO  & ELECTRONIC EQUIPMENT

COMMUNICATIONS COMPANY, Inc.

CORAL GABLES 34, FLORIDA

#### NEW PATENTS

(Continued from page 150)

Across each of the junctures not connected to line 18 is provided an inductive reactance in the form of a transmission line section to compensate for the capacitances 16 and 17; stubs 23 and 24 are adjustable.

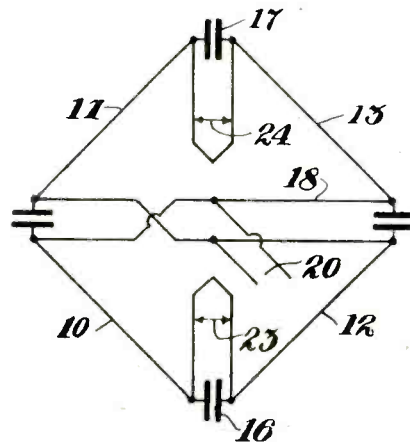

The diagram illustrates the resistance and phase angle characteristics of an actual loop antenna constructed according to the invention.

A. Alford, C. A. Segerstrom, and H. N. Capen, Federal Telephone and Radio Corp., (F) March 18, 1943, (I) April 3, 1945, No. 2,372,651.

#### WIDE READING

(Continued from page 111)

$$V = H d v 10^{-8} \text{ volt,}$$

where  $d$  designates the diameter of the pipe,  $v$  the average fluid velocity, and  $H$  the intensity of the magnetic field. The above equation suggests the possibility of using this arrangement for two different purposes, as flowmeter and as meter for magnetic fields. The paper is confined to the discussion of the measurement of flow.

The table illustrates the good agreement between the electromotive force induced in mercury as

$H$ oersteds	$d$ cm	$\bar{v}$ cm/sec.	$V$ calc. microvolts	$V$ meas. microvolts
1350	0.150	231.0	467.0	470.0
1350	0.246	21.5	71.5	71.2
1350	0.395	9.97	53.2	53.4

calculated from the equation and the value determined experimentally by means of a galvanometer. Since the electrical conductivity does not appear in the equation, the induced voltage is seen to be independent of the resistivity of the liquid. This is demonstrated by measurements. Consequently, the method is not limited to mercury but applies equally well to the flow of salt solutions and of tap water. It is proved mathematically that the expression is valid for axially symmetrical flow provided  $v$  denotes the average axial velocity; in the derivation, the velocity is assumed to vanish at the pipe wall.

To avoid polarization of the elec-

(Continued on page 158)



# PLASTICS . . . and . . . POWER

*for your coming products*

● We'd like to reidentify ourselves as the producers of two products not ordinarily associated in manufacture, but often in use. We refer to our molded plastics . . . and our low-torque, *Smooth Power* motors and small electric assemblies.

Our plastic molding ability is well known to many leading manufacturers. Their repeat purchases show their satisfaction at the alertness of our engineers, the ingenuity of our mold makers and the skill of our machine operators. You'll find General Industries' molded plastic parts in homes, offices and industry . . . on your transportation systems . . . yes, they help make the clothes you wear and the foods you eat.

Our *Smooth Power* electric drive mechanisms are built into many phonographs, recorders and combination record-changer-recorders which you play in your home or to whose music you listen on your radios. Their smoothness, quietness and dependability spring from long years of fine designing and accurate building, and fit them for domestic, commercial or industrial products where such characteristics are essential.

At present, our production is 100% military or priority. But, the time is not too far distant, we hope, when we can discuss peacetime business. When that day comes, we'd like to work with you on your needs for *molded plastics* . . . and small *motors*.

**THE GENERAL INDUSTRIES COMPANY**  
ELYRIA . . . OHIO

1



2

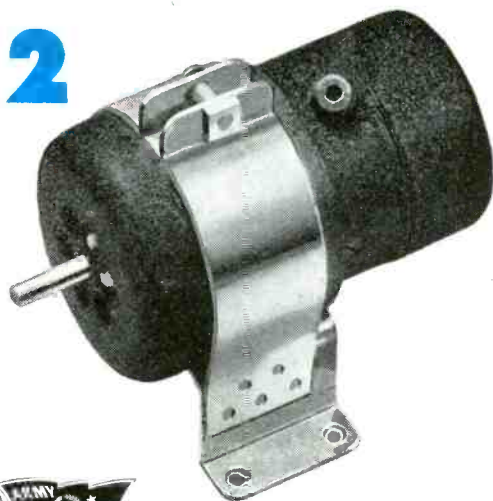

THE  
**GI** GENERAL  
INDUSTRIES  
COMPANY  
**MOTORS** **PLASTICS**

# POSTWAR TRANSFORMERS

BY

## FOSTER

Facilities for peacetime manufacture of transformers are already available at A. P. Foster, and, as war commitments are filled, will be increasingly at your service.

During the war years A. P. Foster has supplied thousands of custom-designed and custom-built transformers to all branches of our armed services, for use in all parts of the world under great extremes of climatic condition.

High production schedules have been maintained by advanced Foster manufacturing techniques. High standards of performance were demanded, achieved and will be maintained—to the benefit of America's peacetime economy.

As your own reconversion plans advance from the conference stage to the blueprint stage, it may well be worth your while to bear in mind that Foster engineers and designers are ready now to consult with you on every transformer problem and to furnish estimated costs and delivery schedules on experimental or quantity production of standard transformers or special jobs custom-built to your own specifications.

● BOB REID, 810 West 57th Street, Indianapolis 5, Ind., Telephone Broadway 2725

● BAUMAN AND BLUZAT, 2753 West North Avenue, Chicago 47, Ill., Telephone Humbolt 8809-10-11-12

● THE A. P. FOSTER COMPANY, BARRETT BORDER, 11 W. 42nd St., New York 18, N. Y., Telephone PENnsylvania 6-9133

SPECIALISTS IN BUILDING TRANSFORMERS SINCE 1938

# A. P. FOSTER COMPANY

TRANSFORMER ENGINEERS & MANUFACTURERS

719 WYOMING AVENUE, LOCKLAND 15, OHIO (SUBURB OF CINCINNATI)



# SOMETHING **NEW** AND **BETTER** IN ELECTRICAL INSULATION

**R**ECENT laboratory accomplishments have made possible new grades of Formica laminated plastics that have many qualities that were not before available in combination in any one material.

The development of new materials—glass cloth and glass mat fibre bases, and Melamine resins—have made this possible.

Among these new grades are varieties that stand more heat and more arcing than laminated material would take before. Others provide greater mechanical strength. And some are more efficient insulators of high frequency currents, approaching ceramics in that regard, but providing strength and vibration resistance for parts that must perform important structural functions.

As all of these grades are free from cellulose they resist fungus growth. Water absorption is low and does not affect either stability of dimensions or stability of electrical characteristics.

All grades are machinable—adapted to quick efficient production methods. Engineering details on request.

**THE FORMICA INSULATION COMPANY**  
4647 Spring Grove Avenue • Cincinnati 32, Ohio

**FORMICA**

# Specialists in Special Crystals

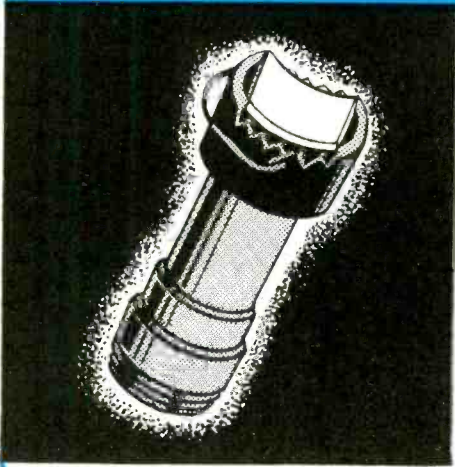

"Searching Unit" for Sperry Products' Reflectoscope



Yankee Ingenuity  
makes us

SPECIALISTS IN SPECIAL CRYSTALS

## SUPERSONIC CRYSTALS

Curved . . . spherical . . . or flat supersonic crystals for a full range of biological, chemical and materials testing purposes. Crystalab is specialist in them all. That's why leading manufacturers like Sperry Products, Inc., whose renowned Reflectoscope employs our supersonic crystals — come to us with their problems.

If you have a problem or product involving the use of supersonic crystals, our engineers will be glad to have you consult them.

Write Dept. E.I. for comprehensive catalogue "Electronic Crystals" and facilities booklet "Crystalab Solves a Problem".



**CRYSTAL RESEARCH LABORATORIES**  
INCORPORATED  
HARTFORD, CONNECTICUT

## WIDE READING

(Continued from page 154)

trodes, the constant magnetic field was replaced by an alternating one. However, an undesired alternating 60 cycle electromotive force is induced which is independent of the state of motion of the liquid. This disturbing signal is balanced out at zero flow by means of the compensator indicated in the figure. The filter is connected to the grid of the third amplifier stage.

Electrode material and other design factors are discussed. A self-contained small instrument based on the same principle and intended to study the velocity distribution in an open channel, a large pipe, or a river is described. Calculations and measurements indicate the possibility of measuring with this device velocities in the order of 1 inch/sec.

## Space Charge Effects in Beam Tetrodes

G. B. Walker (Wireless Engineer, London, April, May and June, 1945).

A theoretical study is made of the effects of space charge between the screen grid and plate of a beam tetrode; the "knee" in the plate current-plate voltage characteristic is explained and its occurrence correlated with the dimensions and operating voltages of the tube. Planar electrodes are assumed.

### Formation of knee

When the plate voltage is decreased to a critical value  $V_K$ , Fig. 1, certain of the electrons which

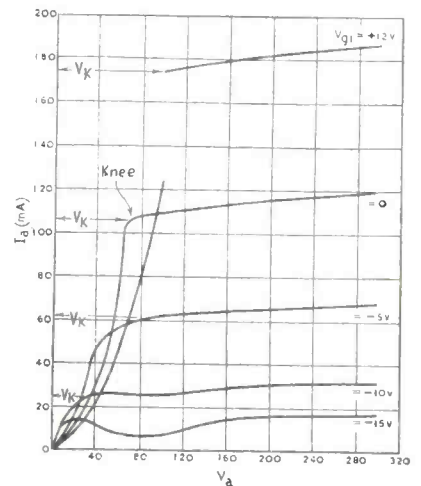

Fig. 1—Current-voltage characteristic of tetrode

have crossed the screen grid fail to reach the plate and are reflected back, eventually to be collected by the screen. This marks the onset of the knee, for, as the plate voltage is reduced further, more and more electrons are returned to the screen and the plate current soon dies to zero.

(Continued on page 164)



## Fungus-Proofed Waxes

As a vital service to the Armed Forces we now offer Fungus Resistant Materials. These recently developed products are the answer to Communications requirements where the impregnation or coating of radio parts and equipment are concerned.

ZOPHAR waxes and compounds meet every specification of both the Army and Navy for waterproofing and insulating all electrical and radio components. They also have wide application in packaging of every description.

**ZOPHAR MILLS** I C N

112-130—26th STREET  
BROOKLYN, N.Y.

ESTABLISHED 1846



# N-Y-T can put a finger...

## ON YOUR TRANSFORMER REQUIREMENTS

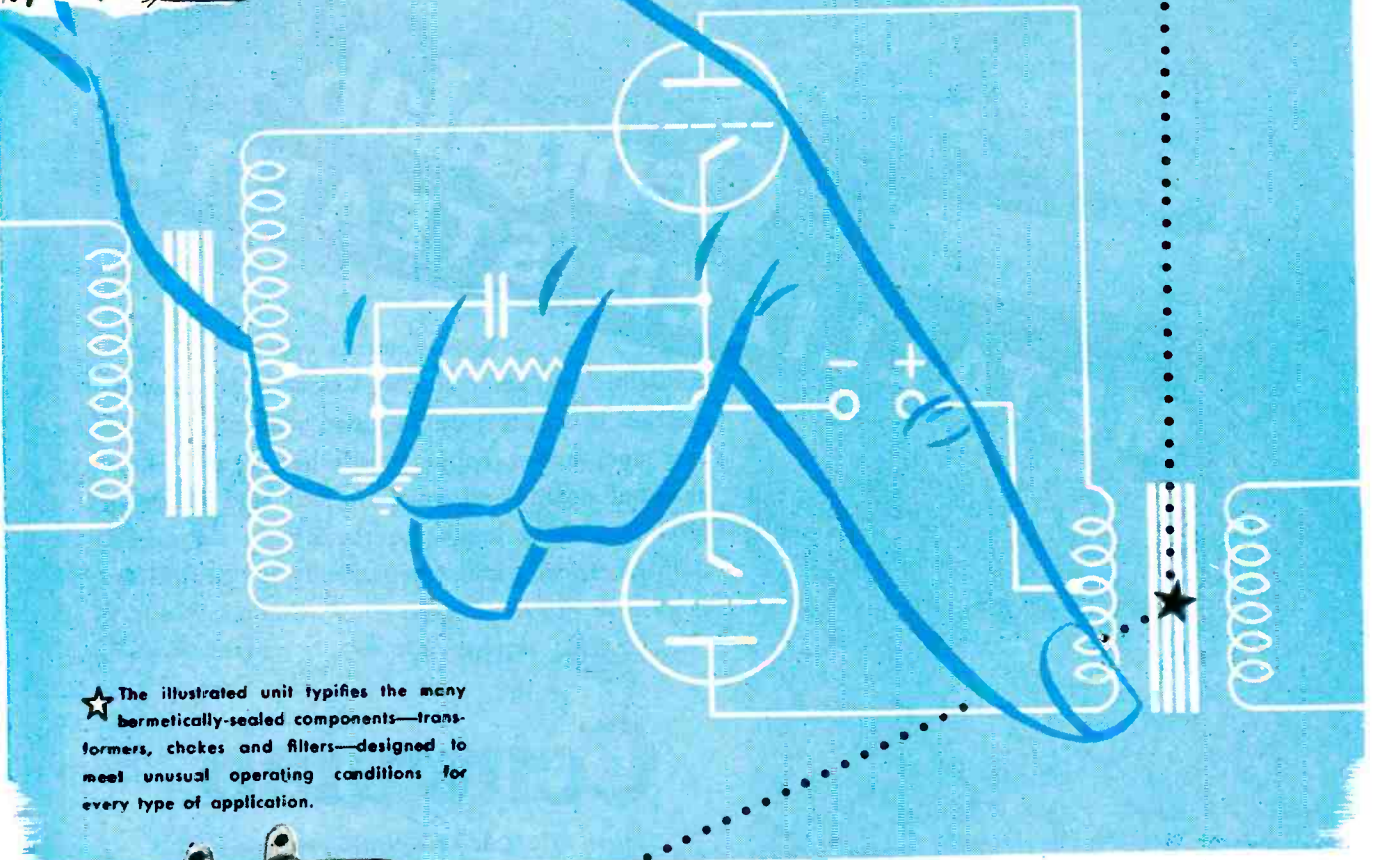

★ The illustrated unit typifies the many hermetically-sealed components—transformers, chokes and filters—designed to meet unusual operating conditions for every type of application.

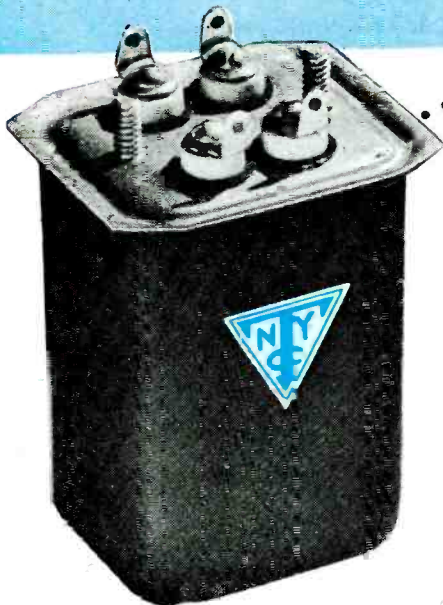

**—with emphasis on electrical and mechanical suitability!**

The N-Y-T Sample Department has demonstrated its ability to continuously supply advanced transformer, choke and filter designs for most electrical and electronic needs. In every instance, all requirements are fulfilled efficiently, and economically.

Let us take care of any samples you may need for new equipment being designed.

*Inquiries are invited; address Dept. N*

**NEW YORK TRANSFORMER CO.**

26 WAVERLY PLACE, NEW YORK 3, N. Y.



# Centralab METALLIZED STEATITE

COIL forms, spacer rods, strain insulators and rotor shafts of steatite can now be bonded in an inseparable union with brass, stainless steel, silver, copper and other metals. These shafts of steatite and metal are indicated wherever high frequency insulating material is specified. Both electrically and mechanically they fulfill the most exacting requirements. . . . Centralab is now

equipped to supply metallized Steatite in practically any form.



## Centralab

Division of GLOBE-UNION INC., Milwaukee

PRODUCERS OF: Variable Resistors • Selector Switches  
• Ceramic Capacitors, Fixed and Variable • Steatite  
Insulators and Button-type Silver Mica Capacitors.



THERE's a good deal more to an efficient, dependable electrical coil than a routine winding. Basic engineering, for one thing. Engineering that *thinks* right from the conception of each problem.

The proper relationship of many variables must be analyzed, weighed. Anaconda coil engineers put emphasis on the correct type, size, shape, insulation, cost, as well as winding.

The quality of the magnet wire also is important. Anaconda controls it from raw copper, through fabrication, to application on the finished coil.

This means that as a coil producer Anaconda also has the advantage of its long experience in making magnet wire. By the same token, Anaconda magnet wire production benefits by Anaconda coil experience.

Add to these features Anaconda's excellent manufacturing facilities and expertly trained personnel.

Anaconda engineering service for coils and magnet wire is always yours for the asking. Contact any sales office.

46301

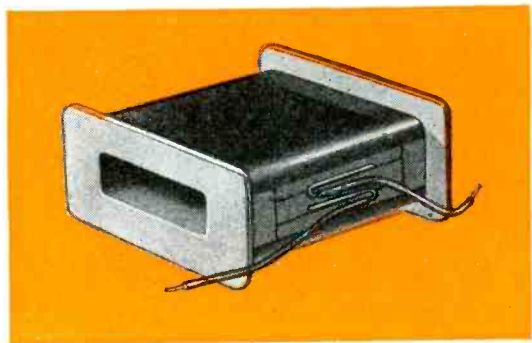

*Magnet wire and coils*



## ANACONDA WIRE & CABLE COMPANY

GENERAL OFFICES: 25 Broadway, New York City 4

CHICAGO OFFICE: 20 North Wacker Drive 6 • Sales Offices in Principal Cities

*Subsidiary of Anaconda Copper Mining Company*

# THE *Quiet* BALLENTINE RECORD CHANGER MOTOR

Has these four characteristics achieved by advanced design, skilled engineering and precision manufacturing.

- Lowest Rumble • Highest Efficiency
- Most Compact Design • Longest Life

The *Quiet Ballentine* Changer Motor is recommended to record changer manufacturers seeking to provide the ultimate in performance.

RUSSELL  
ELECTRIC CO.  
366 West Huron Street  
Chicago 10, Illinois  
*Manufacturers of*  
BALLENTINE  
RECORD  
CHANGER  
MOTOR

*Quiet*

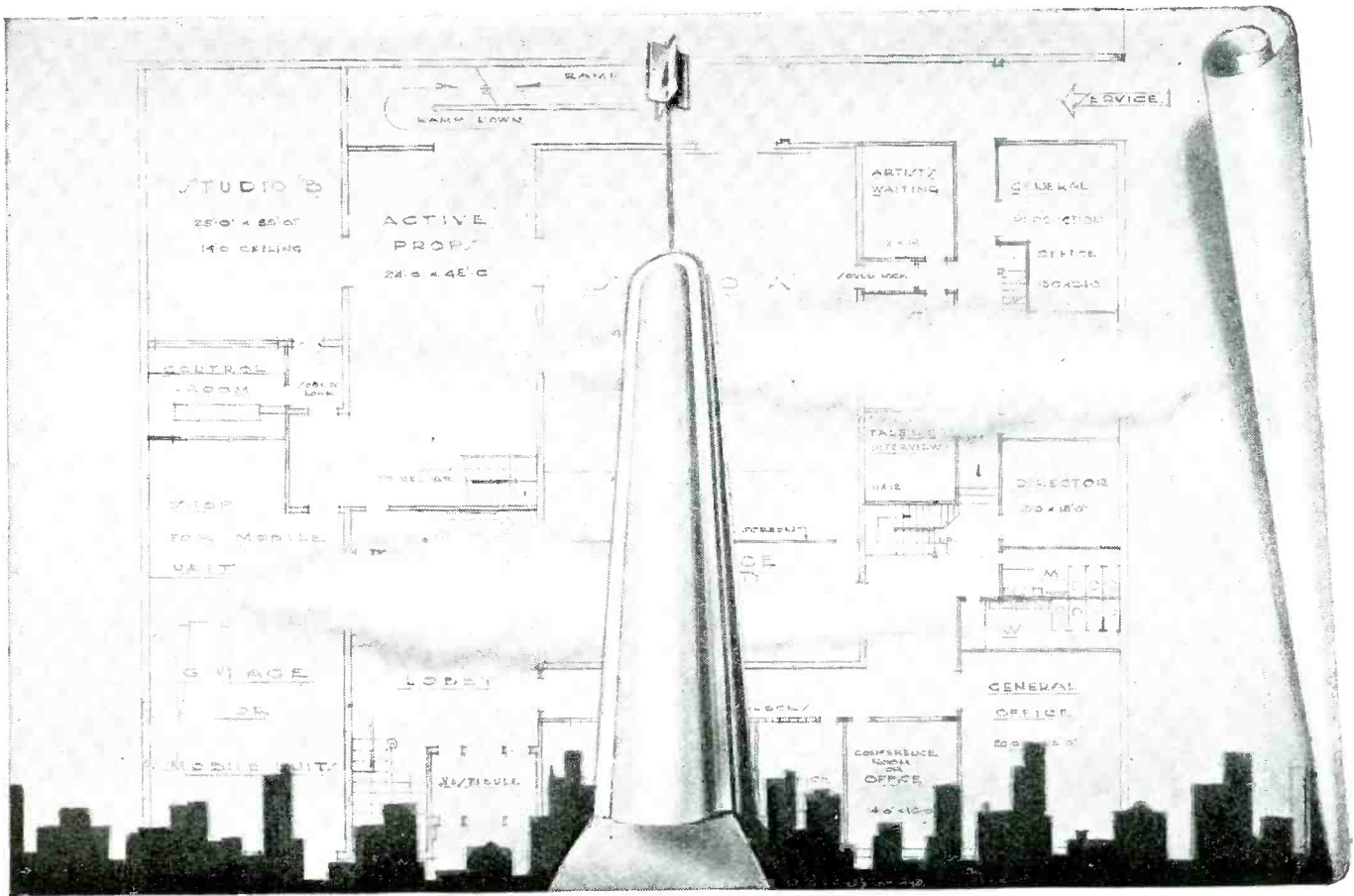

## DUMONT — FOR THE PATTERN OF TOMORROW'S TELEVISION

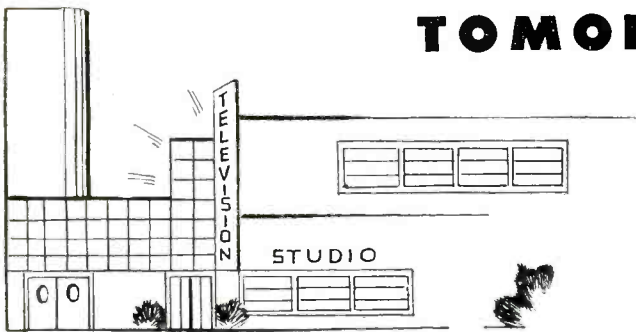

### TO PROSPECTIVE TELEVISION STATION OWNERS...

DuMont has pioneered a pattern for the peacetime commercial operation of a typical television station—a pattern that is yours for study whenever you wish.

DuMont has designed and built *more* television

stations than any other company—stations that, week after week, are demonstrating the simplified precision control of DuMont-engineered equipment, its low operating cost, extreme flexibility, high efficiency and rugged dependability.

DuMont postwar designs incorporate all the flexibility and refinements accruing from more than four years of continuous and increasingly elaborate programming experimentation. Early peacetime delivery is assured through DuMont's Equipment Reservation Plan, plus competent training of your personnel.

Visit DuMont's Station WABD, New York...our Sales Manager will gladly make arrangements.

Copyright 1945, Allen B. DuMont Laboratories, Inc.

# DUMONT



*Precision Electronics and Television*

ALLEN B. DUMONT LABORATORIES, INC., GENERAL OFFICES AND PLANT, 2 MAIN AVENUE, PASSAIC, N. J.  
TELEVISION STUDIOS AND STATION WABD, 515 MADISON AVENUE, NEW YORK 22, NEW YORK

# ARNOLD *makes* PERMANENT MAGNETS

FROM START

TO FINISH

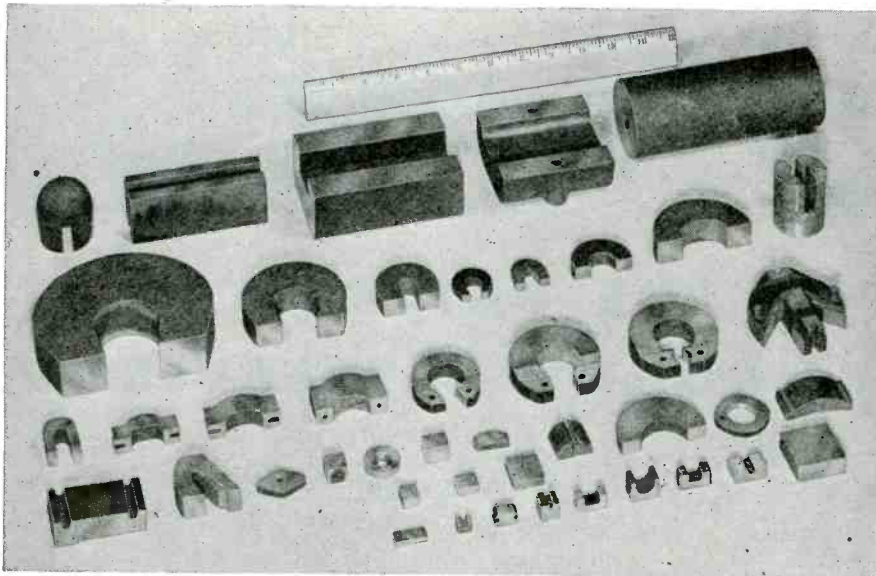
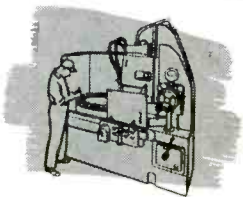
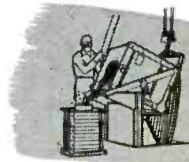

A representative assortment of Miscellaneous and Electrical Instrument Magnets.

The Arnold Engineering Company has a completely integrated plant for the manufacture of Alnico Permanent Magnets, from the melting and casting of the raw materials to the final fabrication of the completed magnets.



## THE ARNOLD ENGINEERING COMPANY

147 E. ONTARIO ST., CHICAGO 11, ILLINOIS

SPECIALISTS IN THE MANUFACTURE

OF ALNICO PERMANENT MAGNETS

## WIDE READING

(Continued from page 158)

Electrons traversing the grid close to a grid wire (path 3 in Fig. 2) acquire the maximum tangential velocity component imparted to

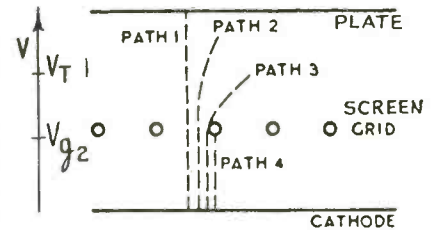

Fig. 2. Electron paths as deflected by grid wires

them by the positive screen grid potential; these electrons will be the first to return to the screen grid. An expression for the maximum tangential velocity component is derived and the voltage  $V_T$  at the plane between screen grid and plate where the electrons start returning to the screen grid is computed by equating the kinetic energy of the electron to the potential energy of the electrostatic field:

$$V_T = \frac{1}{V_{g2}} \times \left\{ \frac{p_2 \mu_2 (x_{12} + x_{2a}) \left[ 1 - \frac{d_2}{2\pi x_{12}} \ln \frac{d_2}{8x_{12}} \right]}{4x_{2a}(x_{12} + x_{2a} + \mu_2 x_{12})} \right\}^2$$

where  $V_{g2}$  is the screen grid voltage,  $p_2$  pitch of the screen grid,  $\mu_2$  amplification factor of a hypothetical triode whose cathode coincides with the control grid of the tetrode,  $x_{12}$  spacing between control grid and screen grid,  $x_{2a}$  spacing between screen grid and plate, and  $d_2$  wire diameter of the screen grid.

When the electric field is not modified by space charge, the knee commences at the point of the plate current-plate voltage characteristic at which the plate voltage is equal to  $V_T$ , then  $V_K = V_T$ . If space charge is present, a criterion for the onset of the knee is that the lowest potential between the screen grid and plate has the value  $V_T$ .

### Effect of space charge

It is to be expected that the tangential velocity acquired by the electrons is in some way dependent on the distance from the mid-line between the two wires of the point at which the electrons crossed the screen, if the electron density in the screen plane is assumed to be constant. Two likely distribution laws are considered: (I) the square of the tangential component is uniformly distributed, (II) the tangential velocity component is uniformly distributed.

From the normal velocity components corresponding to the tangen-

(Continued on page 168)

*Keep it Dry  
with Jay Cee  
Silica Gel*



## Avoid Moisture Damage in Over-Seas Packages

Simply put a few small bags of Jay Cee Silica Gel, like the ones above, inside your container . . . wrap or seal tightly . . . and ship over-seas without fear of damage from "in-the-package" moisture. Jay Cee Silica Gel is an ideal drying agent . . . has amazing power to absorb atmospheric moisture. Thus the air inside of containers is kept absolutely dry and delicate metal parts are protected from rust and corrosion.

Jay Cee Silica Gel is also used in pack-

ages of foods, fabrics, chemicals, and other products. Moreover, it has wide application in the air conditioning, refrigeration, and chemical industries. Jay Cee Silica Gel is clear white; passes a rigid section test; meets exacting Government specifications; is strictly a quality product.

**JOBBER WANTED** — There are excellent opportunities for jobbers to build profitable business on Jay Cee Silica Gel in a few territories. Write for details.

JOLIET CHEMICALS, LTD., INDUSTRY AVENUE, JOLIET, ILLINOIS



# SILICA GEL

*A superior dehydrant*

# A COMPLETE RADIO STATION all in one package!

Typical of ERCO'S engineering ability to build completely coordinated Radio Stations is the unit illustrated. Built for Sperry Gyroscope Company, Inc., this equipment unifies a 200-watt radio telephone and telegraph transmitter, three 32-D fixed frequency receivers, one variable frequency receiver, speaker panels and operating position.

Variations of the illustrated console, in any combination of equipment, are available for your own needs. Panel assemblies can be interchanged to any arrangement. Each is replaceable to eliminate obsolescence.

ERCO'S specialized knowledge and technique is reflected in custom-built equipment for such varied users as Pan American Airways, American Airlines, General Motors, Eastman-Kodak, Grumman, Sperry, National Carbon, Westinghouse, and the Hudson's Bay Company.

Whatever your requirements . . . police, airline or industrial; mobile, ground to air, base to branch, office to field . . . ERCO provides complete service in the design, manufacture and installation of equipment that is engineered specifically to meet YOUR needs. We invite your inquiry.



## ERCO RADIO LABORATORIES INC

HEMPSTEAD, NEW YORK

Manufacturers of CUSTOM BUILT RADIO APPARATUS

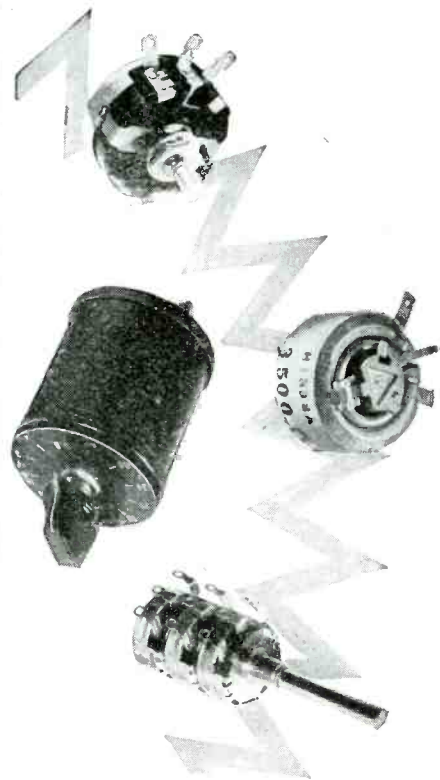

## Products of "THE HOUSE OF RESISTORS"

★ Wire-wound or composition-element volume controls, T-pads, L-pads, mixers, etc.; power rheostats; constant-impedance output attenuators; power resistors; flexible resistors and glass-insulated resistors; voltage-divider resistor strips; metal-tube ballasts and resistors—these and other resistors, controls and resistance devices, comprise the exceptionally complete line of CLAROSTAT—products of "The House of Resistors."

Consult us regarding your resistors, controls and resistance device problems.



CLAROSTAT MFG. CO., Inc. - 285-7 N. 6th St., Brooklyn, N. Y.



# *Search Warrant for Spring Trouble*

Spring coiling can, and often does, become a very complicated and vexing problem where both machine and material must yield peak performance in order to meet critical dimensional and test specifications.

Then ordinary methods of analyzing the product deviations and its many possible causes are out. Only unusual technical skill supported by advancing instrumentation can succeed in obtaining the desired solution. All of the many special electronic devices used in regular production and for special investigations are designed and constructed by Hunter's Special Apparatus Division. If you agree we go to more trouble to make springs right than you expected of leading springmakers, we can only say—you haven't seen anything yet.

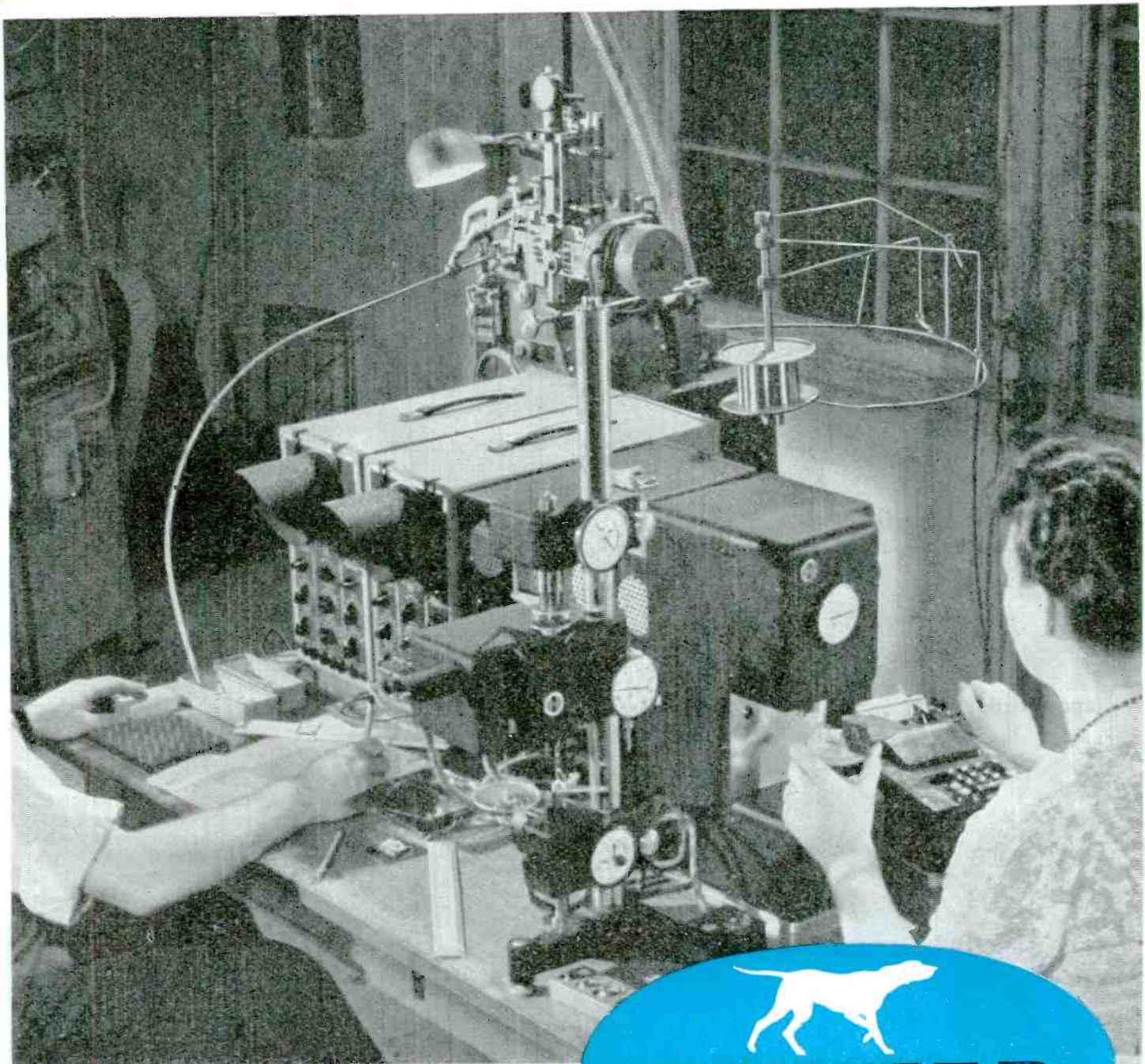

HUNTER PRESSED STEEL COMPANY, LANSDALE, PENNA.

Springs Metal Stampings, Wire Forms, Mechanical and Electrical Assemblies.

# In Vacuum Gauges . . . its the new

# Alphatron

No. 3 in series on new developments in the field of High Vacuum

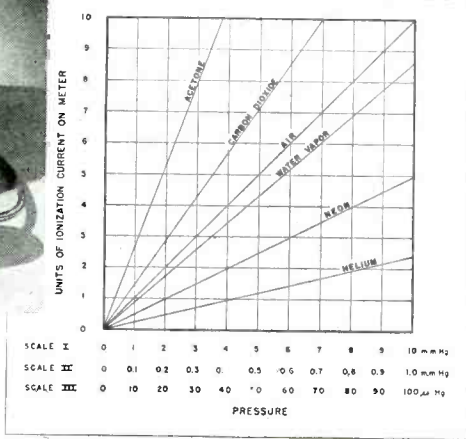
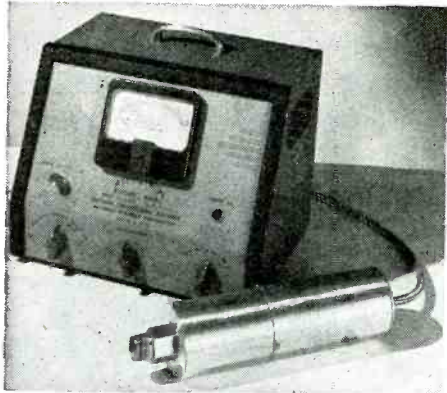

Alphatron Gauge Type 510 Preliminary Calibration Scale

**1 micron to 10 millimeters** . A single gauge giving continuous linear indication of pressure in three ranges: 1-100 microns; 1-1000 microns and 1-10 millimeters.

**instantaneous response** . The Alphatron utilizes the ionization effect of alpha particles. This new principle enables instantaneous response to pressure change and thus avoids lag in readings.

**undamaged by atmospheric pressure** . . . . The flow of alpha particles is produced from a sealed radium source. There is no filament to burn out, and the gauge is unaffected by exposure to atmospheric pressure.

**simple calibration for different gases** . . . . The graph above shows that the Alphatron has linear reactions to pressure throughout its entire range. Calibrated for dry air the standard Alphatron may be used directly for other gases by means of calibration factors. Excellent for use with systems containing water vapor and for leak detecting.

**specifications** . . . . Control box: size 12 5/8" x 9 1/4" x 9 3/8", weight 20 lbs., finish grey and black crackle with red trim; gauge (including first state amplifier); size, 12" x 3" O. D., weight 5 lbs., finish natural; cables: 10 feet special 10 conductor; power 110 volts, 60 cycle, A. C., 1 ampere; calibration as shipped: dry air; shipping weight; approximately 27 lbs.



For full particulars send for bulletin G-3.

## WIDE READING

(Continued from page 164)

distribution I, the charge density distribution and, by means of Poisson's equation, the resulting electrostatic field is computed for the onset of the knee, i.e., the lowest potential between the screen grid and plate has the value  $V_i$  at which electrons start returning to the grid. Eventually the expression

$$x = 0.0444 \cdot \sqrt{\frac{V_r^{3/2}}{i}} \cdot f\left(\frac{V}{V_r}\right)$$

is arrived at,  $x$  is the distance from the voltage minimum  $V_i$  in mm,  $V$  the potential at  $x$  in volts,  $i$  the current density in mA per mm<sup>2</sup>; the function  $f(V/V_r)$  is plotted in the diagram of Fig. 3.

By substituting  $V_{k2}$  (effective screen grid potential) or  $V_p$  (plate potential) for  $V$  in the equation, the distance of the potential minimum  $V_r$  from the screen grid or plate, respectively, is obtained.

A procedure to find the plate voltage  $V_k$  at the knee is indicated. The minimum current density at which a potential minimum of the required value may occur is evaluated as:

$$i = \frac{(0.0444)^2 V_r^{3/2} f^2(V_g/V_r)}{(x_{2a})^2}$$

An identical derivation for the second velocity distribution law leads to an expression where  $f(V/V_r)$  is replaced by  $\phi(V/V_r)$ ; the

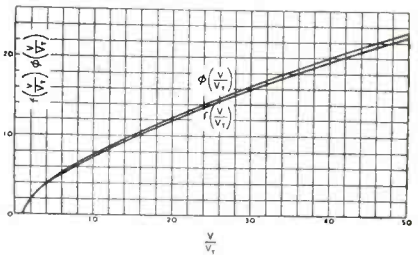

Fig. 3, Functions to evaluate formula for  $i$

two functions are very close as will be seen in Fig. 3.

An investigation of the reduction in charge density due to the emission velocity distribution of the electrons leaving the cathode, shows that it is negligible under normal operating conditions.

### Further considerations

The potential distribution in the screen-grid-plate region is computed for the cases when the potential minimum is either greater or smaller than the potential  $V_r$  required to make the electrons turn back to the screen grid. The complicated relations obtained are

(Continued on page 172)



# VACUUM OIL IMPREGNATING

## AMERTRAN HERMETICALLY SEALED TRANSFORMERS

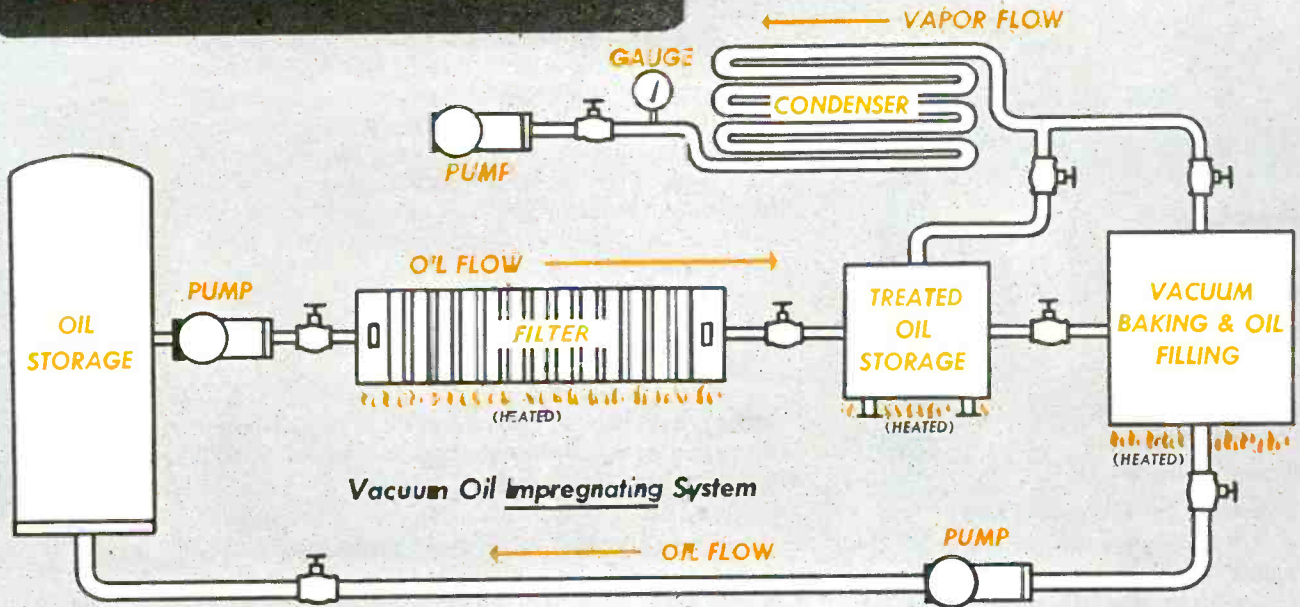

Vacuum Oil Impregnating System

*Saves Weight  
Minimizes Corona  
Increases Dielectric Strength  
Saves Space*

Note bellows construction of enclosing case. Compensates for pressure changes—makes possible complete filling.

**OTHER FINE POINTS**  
Uniform characteristics—correct terminations—vacuum test—vacuum varnish coil treatment—strong mechanically—soldered by induction heating—continuous inspection and 42 YEARS EXPERIENCE IN MANUFACTURING TRANSFORMERS.

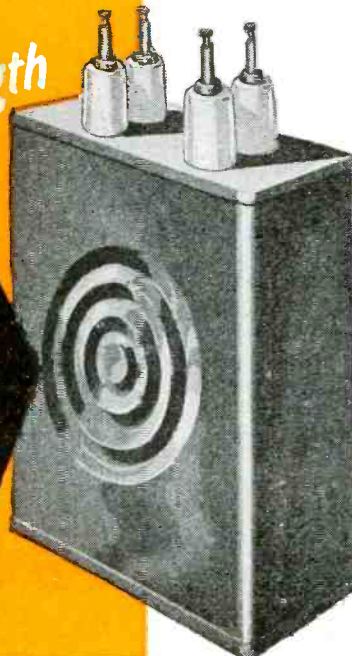

### Why the Dielectric's all oil!

No Volatiles—No Air—No Moisture—No Sludge

Combination of 230 degrees F. heat and an absolute pressure of 1 mm. of mercury rids oil of volatiles, air and moisture. Filter removes sludge and all foreign matter. Transformers are likewise subjected to this combination of heat and vacuum for five hours—effecting thorough dehydration. At the conclusion of this period, the treated oil is admitted to the impregnating tank, covering transformers for twenty minutes. Closure is effected under immersion (at process or room temperature as specified), then transformers are removed from bath for sealing. And this is but one of the many features of AmerTran's quality construction.

THE AMERICAN TRANSFORMER CO., 178 Emmet St., Newark 5, N. J.

# AMERTRAN

REG. U. S. PAT. OFF.  
MANUFACTURING SINCE 1901 AT NEWARK, N. J.

Pioneer Manufacturers of Transformers, Reactors and Rectifiers for Electronics and Power Transmission



# Amazing . . . New and FOOL-PROOF!



*Fool Proof*

BECAUSE:

- \*1. Single Button Control
- 2. Automatic Shut-Off after last Record<sup>\*</sup> is Played (Tone arm returns to rest)
- \*3. Most Natural Manual Play (No special setting needed)
- 4. Automatic Shut-Off after Manual Play (Tone arm returns to rest)
- \*5. Absolutely no Chipping of Records (Record selector principle prevents all chipping)
- \*6. Negligible Wear of Record Center Hole (Practically no wear for entire life of record)
- \*7. Record Selection Independent of Record Warp or Edge Condition
- \*8. Plays Excessively Worn or Chipped Records
- \*9. Tone Arm Can be Handled without Injury to Mechanism
- \*10. No Complicated Operating Instructions Necessary.
- \*11. No Jamming with any Standard Commercial Records

\*Applies also to Model 205

**G. I.**'s new Record Changers once again establish a new high on two scores—1. *Technical appeal*—2. *Beauty of appearance*.

Behind these post-war G. I. Changers is a proven record of service-free performance. We're proud of that — and to insure its continuance these new models have, for more than a year, been subjected to rigorous testing in eight different industry laboratories. New features have been added that never before were feasible at comparable cost. Even its new eye appeal was evolved through the combined inspiration of several internationally famous designers. Final design choices were made by stylist juries.

Simplicity of styling and fool-proof functioning have been our objectives and we are told that the product justifies our efforts.

More than ever you can look to G. I. to lead in record changer design and production and we solicit your suggestions for continuation of our program.

## Quality Features

- 1. One RPM Change from Single Record to Full Stack on Turntable
- 2. Ball Bearing Tone Arm Swivel Bearing
- \*3. Advanced Simplified Styling (by internationally famous stylists)
- \*4. Change Mechanism Disconnected during Playing Cycle
- \*5. Long Service Life
- 6. Both Ratchet and Position Trip
- \*7. Accepts any Standard Crystal Pick-up or Equivalent.
- \*8. Operates over Wide Temperature Range
- \*9. Permanent Factory Adjustment
- \*10. Minimum Dimensions
- \*11. Low Rumble
- 12. "WOW" so low that it "shows up" many recordings

\*Applies also to Model 205



MODEL 205

**GENERAL INSTRUMENT CORPORATION**



# GI

## RECORD CHANGER



MODEL 204

*Just One Control!*

GENERAL INSTRUMENT CORPORATION • 829 NEWARK AVENUE • ELIZABETH 3, N. J.

# SOMETHING NEW—

## STABILIZED LOW VOLTAGE D. C.



### ...EXAMPLE...

CAPACITY ..... 200 amps.      STABILITY .....  $\pm .05$  volt  
VOLTAGE ..... 0-3 volts      SIZE ..... 22" wide, 15" deep, 28" high  
Compensates for load variation and line voltage fluctuation

New voltage stabilization principle is applicable to wide range of selenium rectifier units, 3-120 volts maximum. D.C. capacities to 10 KW (220 volt 3 phase input), 16 KW (440 volt 3 phase).

Detailed description of unit shown available from:

MUNNING & MUNNING, INC.  
202 Emmet Street  
Newark 5, N. J.

A. J. LYNCH & CO.  
2424 Enterprise St.  
Los Angeles 21, Cal.

BRUJAC ELECTRONIC CORP.  
11 Park Place  
New York 7, N. Y.

CROWN RHEOSTAT & SUPPLY CO.  
1910 Maypole Avenue  
Chicago 12, Ill.

**"Rectifier Engineering is our Business"**

SELENIUM • ARGON • MERCURY VAPOR • GRID CONTROL • HIGH VACUUM • XENON

**W. GREEN ELECTRIC COMPANY, INC.**

SELECTRO PLATERS AND ALL TYPES OF RECTIFIER EQUIPMENT

GREEN EXCHANGE BUILDING 132 CEDAR STREET NEW YORK 6, N. Y.

RECTIFIER  ENGINEERS

## WIDE READING

(Continued from page 168)

plotted to facilitate numerical evaluation.

Effect of transverse electric forces such as beam spread due to the mutual repulsion of electrons and the counteracting influence of the equipotential planes at the screen grid and at the plate are studied. Resulting changes in the location of the knee and the shape of the plate voltage-plate current characteristics are discussed.

## Vacuum Casting

K. Rose (Metals and Alloys, May 1945).

A casting method is described for the manufacture of X-ray tube anodes of copper which must be gas-free. Graphite molds are used and the metal is molten by induction heating. The energy is provided by an electronic oscillator heating the metal from 7 to 10 minutes in a vacuum corresponding to a pressure of 0.00001 mm of mercury. The vacuum is maintained during the casting process and the cooling period.

## Indicator for Transient Voltages

T. Offenbacher (Electrical World, May 26, 1945).

The trip characteristics of an 885 Thyratron are used to indicate the presence of a transient voltage exceeding a selected voltage level. The voltage to be investigated for transients is applied to the plate and the grid voltage adjusted by means of a potentiometer to cause the tube to carry current whenever the plate voltage exceeded the selected value. Provisions for interrupting the plate circuit are made; a voltmeter associated with a relay records the number of operations per hour.

The device was used to check for improper relaying and to subsequently indicate the effectiveness of measures taken to eliminate the transients.

## PROJECTION C-R-O TUBE

(Continued from page 113)

difficulty which might exist in focusing the photographic or projection lenses over the whole screen area.

### Operation

The type 5RP tube has the same base as the type 5CP tube, and the same basing except for second anode and deflection plate connections, which are made through the tube neck. However, if the 5RP-tube is to be substituted for the 5LP—or 5JP—types, a change in tube socket is necessary and because of the difference in tube shapes, the magnetic shields must also be changed. Connections to the inten-

(Continued on page 176)



# VICTORY

## over vibration

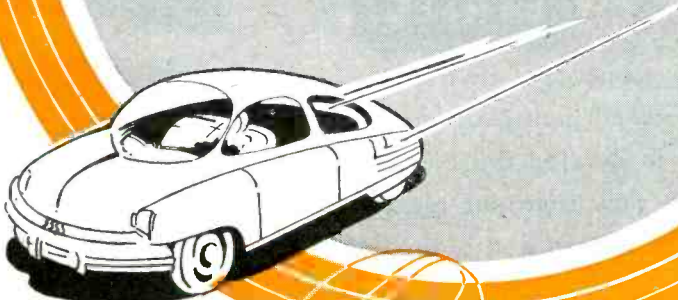

*In War... In Peace...*

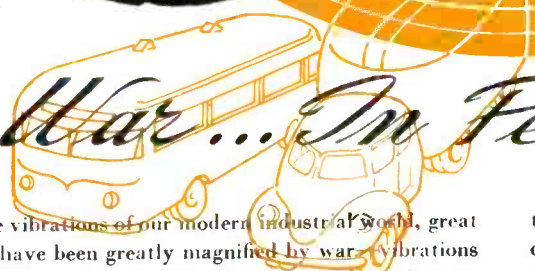

**B**ECAUSE the vibrations of our modern industrial world, great as they are, have been greatly magnified by war—vibrations of mighty radial engines, of roaring Diesels, of deafening explosions, of cyclonic storms and bottomless jungle roads—Lord Manufacturing Company has added much to its store of knowledge concerning control and isolation of vibration. Because Lord had pioneered the field of vibration control for almost a generation, it was called upon for thousands of installations, from Lord Dynafocal Suspension for radial engines to mounts for delicate instruments in the ships that sail the air, the sea and the waters under the sea; for huge gun recoils and precise bomb sights; for more uses than we have space for or are allowed to mention.

Victory over vibration in war applications has paved the way for better control and isolation of vibration in a myriad of peace-

time applications. Whether you manufacture locomotives or baby carriages, dynamos or television sets, turret lathes or laboratory recording instruments, Lord engineers can help you make a product that will serve better and last longer.

Lord Bonded Rubber Mountings are made in two main types, Tube Form and Plate Form, with variations to meet special conditions, and problems arising from internal or external vibration. Lord Mountings are made for load ratings ranging from a few ounces to several thousand pounds. Installation of Lord Mounts is extremely simple, no special tooling or machining being necessary to adapt them to your designs.

Send for the latest Lord literature on Vibration Control and Isolation, or call in our engineers to consult with you on your problems. Neither service entails any obligation.

IT TAKES BONDED RUBBER *In Shear* TO ABSORB VIBRATION

**LORD MANUFACTURING COMPANY**  
 ERIE, PENNSYLVANIA

SALES REPRESENTATIVES  
 NEW YORK - 280 MADISON AVE.  
 CHICAGO - 520 N. MICHIGAN AVE.  
 DETROIT - 7310 WOODWARD AVE.  
 BURBANK, CAL. - 245 E. OLIVE AVE.  
CANADIAN REPRESENTATIVES  
 RAILWAY & POWER ENGINEERING CORP., LTD.  
 TORONTO, CANADA

\* \*  
 BUY WAR BONDS  
 \* \*

**Originators of Shear Type Bonded Rubber Mountings**

# PINCOR



## DC MOTORS

### BX SERIES

The urgent demand, in peacetime days, by the aircraft and radio industries for a compact, efficient D.C. motor was the challenge that led Pioneer to develop the Pincor BX series. Today Pincor BX motors flow from our plant in a steady stream to the producers of aircraft and radio equipment for the armed services.

Pincor BX motors, in their classification; meet the varied requirements of aircraft and radio manufacturers that demand light weight, compact motors for efficient and dependable application. Pincor BX motors are direct drive, ball bearing, high speed units wound for continuous or intermittent duty. Shunt, series or split series windings are for operation on 12 to 24 volt battery systems currently used and may be easily modified to meet your product demand.

Depend on these rugged Pincor quality-proven motors in the BX series. Send your problem to Pioneer engineers and let them put their years of experience to work for you. Consultation with these men will not obligate you in the least.

DYNAMOTORS • CONVERTERS  
GENERATORS  
POWER PLANTS • GEN-E-MOTORS

**PINCOR**  
*Products*

**PIONEER GEN-E-MOTOR  
CORPORATION**

5841-49 DICKENS AVENUE CHICAGO 39, ILLINOIS

Export Office, 25 Warren Street, New York 7, U.S.A.  
Cable Address: Simontrice, N.Y.

BUY MORE BONDS!

# ENGINEERED TO THE APPLICATION

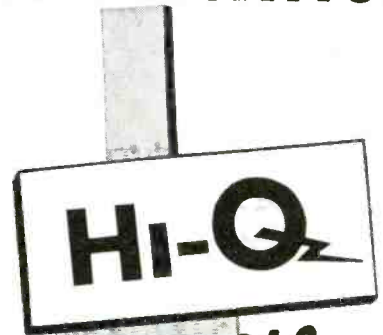

## CERAMIC CAPACITORS

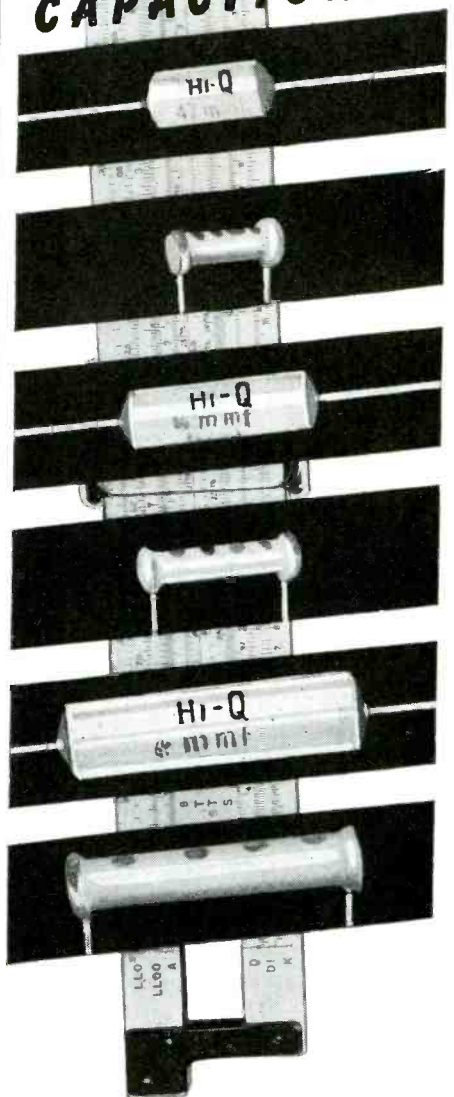

# ELECTRICAL REACTANCE CORPORATION FRANKLINVILLE, N. Y.



# Questions and Answers

ABOUT THE

## 1945 ENGINEERING DIRECTORY

TO BE PUBLISHED *in December* AS A SECTION OF

### ELECTRONIC INDUSTRIES

- Q.** What is the 1946 outlook for radio-electronic production?
- A.** By the time the Directory appears, the radio manufacturing branch of the electronic industries will be producing at full speed. Sales of FM sets and of AM-FM combinations will begin to accelerate rapidly. Television will spurt, too, after January 1.
- Q.** What about government controls?
- A.** Generally, they will be a thing of the past. Cancellation of billions of dollars of orders has left manufacturers with tremendous facilities. In addition to home products, new industrial electronic applications, hidden by censorship since 1941, will prove effective in bringing costs down, efficiency up.
- Q.** Will the demand be greater than prewar?
- A.** It will surpass anything ever known in peacetime. Millions are waiting for improved postwar models of radio receivers, phonograph combinations, FM and television receivers, recorders, as well as new industrial uses developed by war research.
- Q.** Can you build postwar business by advertising in the *ELECTRONIC INDUSTRIES* Directory?
- A.** Yes, if you now have, or will have, a product that can be used to advantage by radio-electronic manufacturers, industrial electronic users, communications services, etc.
- Q.** Must you advertise in the Directory in order to get a free listing?
- A.** No. The listings are a 100% editorial service. But you have the opportunity to use advertising space to amplify your listings or catalog your products.
- Q.** How are the free listings obtained?
- A.** By filling out and returning promptly the questionnaires we have mailed to all producers. It is of the utmost importance to you and to us, that full information be given in these questionnaires.
- Q.** WHO publishes *ELECTRONIC INDUSTRIES*?
- A.** Caldwell-Clements, Inc. (Orestes H. Caldwell and M. Clements, editor and publisher respectively, the pioneers and present-day leaders in radio-electronic publishing.)
- Q.** What is the closing date for advertising in the December Directory issue?
- A.** November 1, for advertisers requiring composition and proofs. November 10, for complete plates, ready to print.

**14,000 PAID CIRCULATION** of *ELECTRONIC INDUSTRIES* and its Engineering Directory includes a complete coverage of the top-ranking design and production engineers and purchasing agents of all radio manufacturers and fabricators of peacetime radio equipment and television.

**ALSO** the men who initiate and authorize radio-electronic activity in communications systems and plants of all industries. 14,000 paid—the most effective buying power of circulation in the radio-television-electronic industries.

**LISTING MANUFACTURERS OF** finished products, raw materials, parts and components, equipment and accessories, associated apparatus, laboratory equipment, production equipment.

**COMPLETE, CLASSIFIED, CROSS-INDEXED** to include not only a product directory, but the only alphabetical directory interfiled for all manufacturers.

**A COMPREHENSIVE CATALOG** of the products of the radio-television-electronic industries.

*Caldwell-Clements, Inc.*

480 Lexington Avenue

CLEVELAND 14  
1210 Citizens Bldg.  
MAin 8270

New York 17, New York

CHICAGO 6  
201 N. Wells St.  
RANdolph 9225

LOS ANGELES 14  
403 W. Eighth St.  
VAndyke 9348

Telephone PLaza 3-1340

SAN FRANCISCO 4  
68 Post Street  
SUtter 5568

*Better  
and Better*

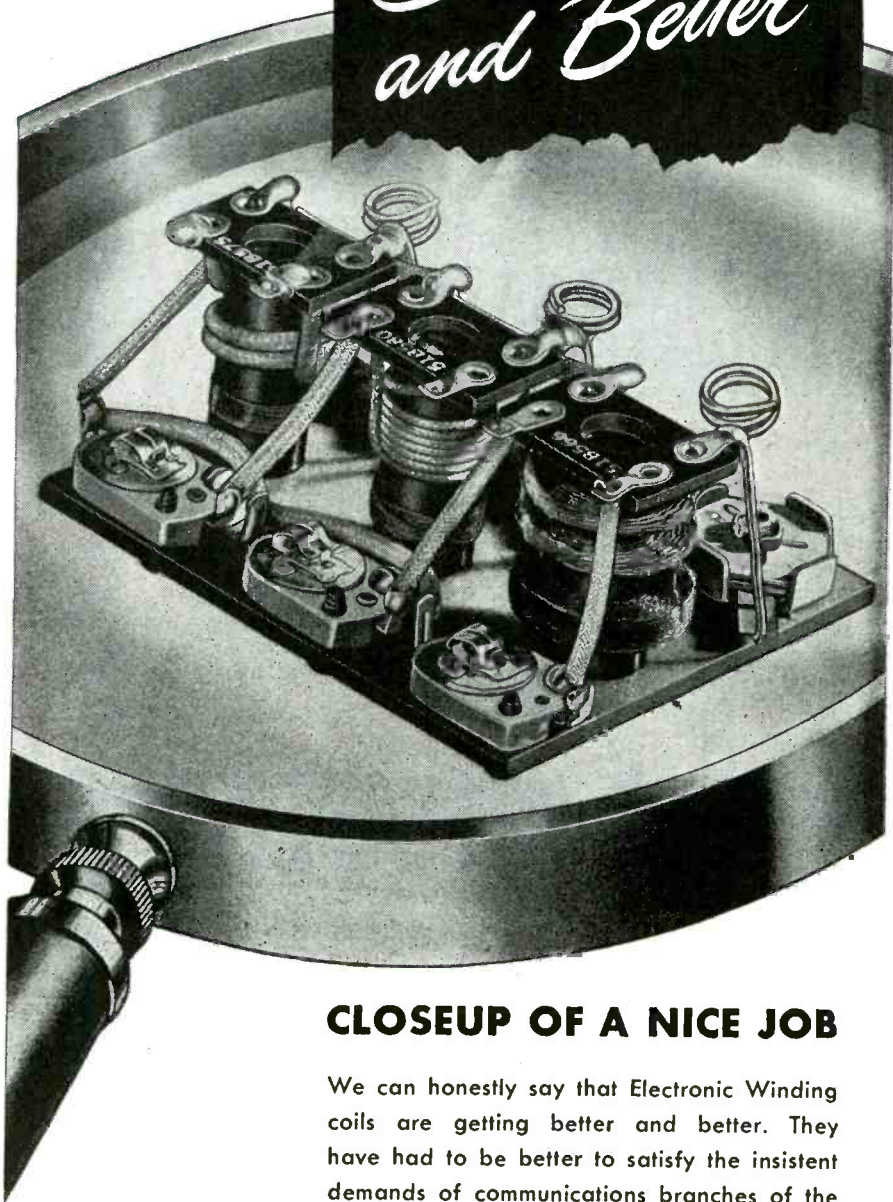

## CLOSEUP OF A NICE JOB

We can honestly say that Electronic Winding coils are getting better and better. They have had to be better to satisfy the insistent demands of communications branches of the armed services and to contribute to the dependability of rugged radio equipment that is helping to save lives all around the world. This closeup of a nice job of coil winding shows a complete RF assembly — just one of the many precise jobs we can do. If specifications call for a coil of extra quality call on Electronic Winding.

# Electronic Winding Co.

5031 BROADWAY  
CHICAGO 40, ILL.

★ ★ MANUFACTURERS OF EXTRA  
QUALITY COILS FOR PRECISION  
COMMUNICATIONS EQUIPMENT

## PROJECTION C-R-O TUBE

(Continued from page 172)

sifier terminals may be made either by connecting only the last ring (next to the screen) to the high voltage terminal, leaving the others floating, or by using a voltage divider. The latter connection results in the best performance.

The high voltage power supply for the 5RP intensifier should be variable, and should be capable of delivering a maximum of 10 times the second anode voltage at which the tube is operated. This means, for operation with existing commercial equipment, an intensifier voltage of 10-15 KV with an output current of about 200  $\mu$ A (including voltage divider current). Voltage in the range of 5 to 8 KV will ordinarily be adequate, except for certain extremely high speed recording. In extreme cases, it may be noted, tubes have been used at voltages far in excess of these ratings, for instance,  $E_{b2} = 5$  KV, and  $E_{b3} = 45$  KV.

### Projection oscillograph

For lectures and classroom demonstrations most standard oscillographs may be readily converted into projection oscillographs by means of the type 5RP1 tube, an external intensifier power supply, and a projection lens. Voltages of about 6 KV for classroom demonstrations and of 15 KV for fairly large auditoriums are satisfactory. The projection lens has an effective speed of about  $f:2$  with a focal length of 8 in. A beaded reflective projection screen is desirable to obtain the best light efficiency.

The type 5RP tube is normally manufactured with either of two screens, the medium persistence, green P-1 type phosphor, for visual observation and projection, and the short persistence, blue (type P11) phosphor for photographic recording and visual observation of transients of extremely short duration of the order of fractions of microseconds.

For photographic recording as well as for visual observation of very high speed single transients, the type 5RP11 tube should be used. It is expected that these new tubes will open new fields to the sealed-off cathode-ray tube with incandescent cathodes, invading the present exclusive domain of the high voltage cold cathode-ray oscillograph, some of which even require photography in the vacuum. The photographic writing rates which so far have been reported, and which, in one particular case went up to 400 inches/microsecond (10,000 KM/sec) for an  $f:1$  lens, and 5:1 picture size reduction, are very encouraging. Application in the

(Continued on page 180)

## COLLINS 32RA RADIO TRANSMITTER\*



## A deservedly popular 50 watter...

THE COLLINS 32RA\* was introduced in 1939 as a quality designed, quality built radio communication transmitter, broadly adapted to most applications within its power and frequency scope.

It, or its d-c version—the 32RB†—was immediately put into service by airlines for control towers, by oil pipelines for emergency systems, by fishing companies for fleet control, and by other widely different types of industrial users.

It was found to be rugged, simple to operate, easy to service, and so thoroughly and universally satisfactory that a rising commercial demand was halted

only by the war. During the entire war the Armed Forces have employed thousands of these transmitters. A typical use has been that of control towers on air training fields throughout the country.

Of the several up-to-the-minute transmitters which Collins has ready for its civilian customers as Government requirements are cut back, this one represents a type of which limited quantities are now being manufactured for essential civilian uses. If you would like specifications and design data, write us for new, illustrated bulletin. Collins Radio Company, Cedar Rapids, Iowa; 11 West 42nd Street, New York 18, N. Y.



\*COLLINS 32RA—Power source: 115 volts alternating current. Power output, 50 watts phone; 75 watts CW. Frequency range, 1.5 to 15 mc. Four frequencies instantly selected by panel control.

†COLLINS 32RB—Power source: 12, 24, 32 or 110 volts direct current. Dynamotor, self contained. Otherwise identical with 32RA.

IN RADIO COMMUNICATIONS, IT'S...



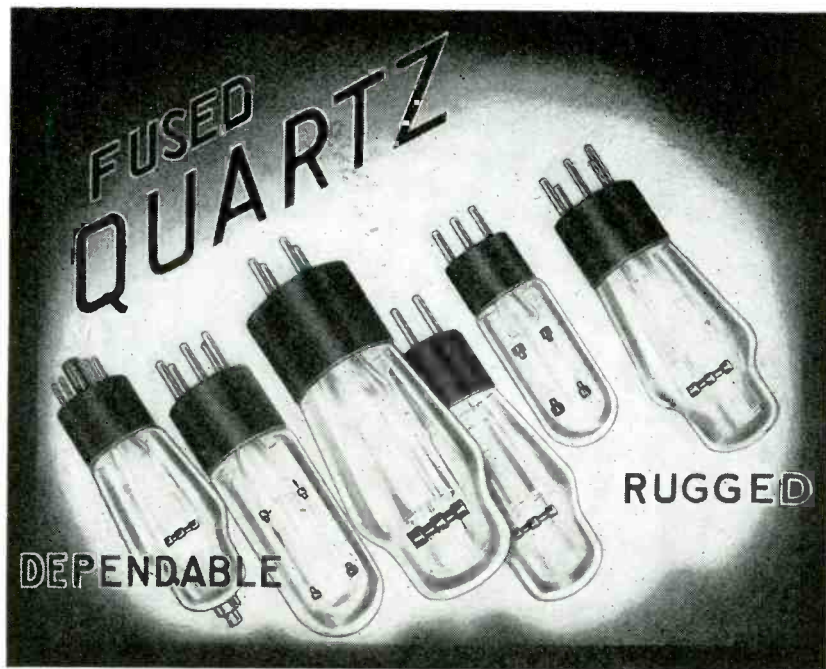

## INSULATORS

are a "main factor" of the high power electronic tube. Quartz is the best electrical insulator known to science. Many other qualities make it ideal for the job. . . . Not subject to thermal shock. Non hygroscopic. High surface resistance. Shaped to specification.

**ULTRA VIOLET LAMPS** (quartz mercury arcs)

**HYDROGEN ARCS IN QUARTZ**

**FUSED QUARTZ ROD,**

**TUBING, PLATES and SPECIAL SHAPES**

# HANOVIA

**CHEMICAL & MANUFACTURING CO.**

Dept. EI-17

NEWARK 5, N. J.

# POSTWAR

## RADIO TRANSFORMERS

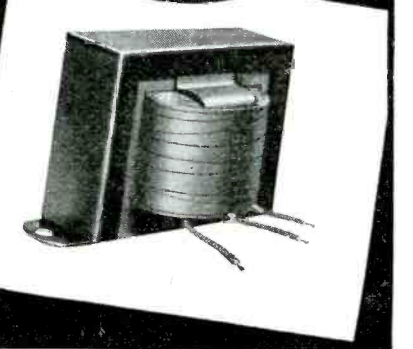
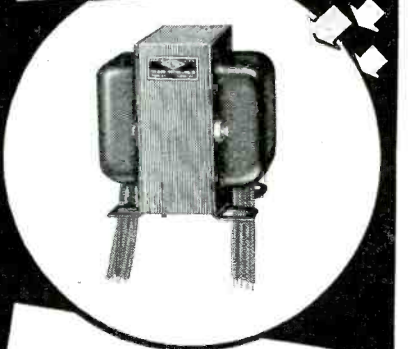
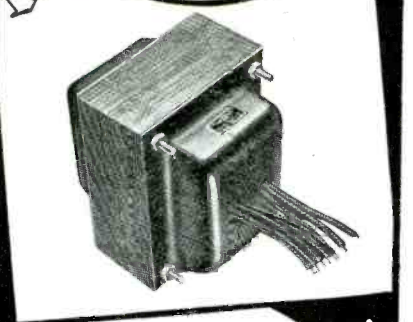
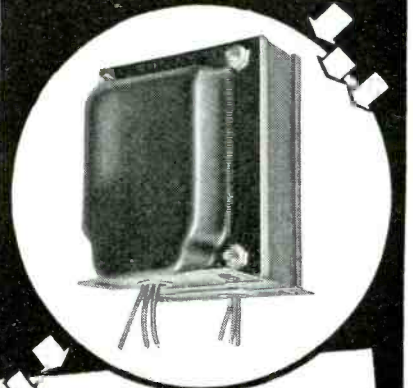

THE ACME ELECTRIC & MFG. CO.  
CUBA, N. Y.

Acme  Electric

# Who sets the *Quality Standard* FOR TRANSMITTING TUBES



WERE it possible, within the limits of this page, to show you all the numerous operations required to construct United Tubes, you would realize why the name United means Quality Standard for transmitting tubes. For the sterling quality of United Electronic tubes is born of a series of unique manufacturing processes vigilantly guarded by Quality Standard Tests. Many are standard procedure; many more are exclusively United features. Those illustrated represent a few of the extra operations which help maintain leadership for United.

Since 1934 United has won recognition by specializing exclusively in the engineering, designing and building of transmitting tubes which are unchallenged for excellence. That is why, with each succeeding year United tubes are used more and more in important places.

Write for a copy of our latest catalog.

ABOVE. No machine can rival the skill of human hands in fitting the precise parts of Electronic Power Tubes. These are the hands of craftsmanship building sterling quality into United Tubes.

\*QST-1—In this United Comparator grids are carefully checked. The slightest variations in grid wire spacings would affect tube characteristics and performance. Critical tolerances are strictly adhered to, and any deviation from precision standards is revealed on the greatly enlarged grid image.

QST-2—Every Thoriated tungsten filament is carburized in a controlled atmosphere chamber to enhance its emitting qualities. It is an added step that assures accurate filament current and maximum emission. This is but one of many procedures that contribute to the dependable performance of United tubes.

QST-3—The tell-tale colors of any glass strains are detected in time by this United Polariscope so that all possibility of glass fatigue is obviated.

\*Quality Standard Test



Masterpiece of Skilled Hands

# UNITED

ELECTRONICS COMPANY

NEWARK, 2



NEW JERSEY

Transmitting Tubes EXCLUSIVELY Since 1934

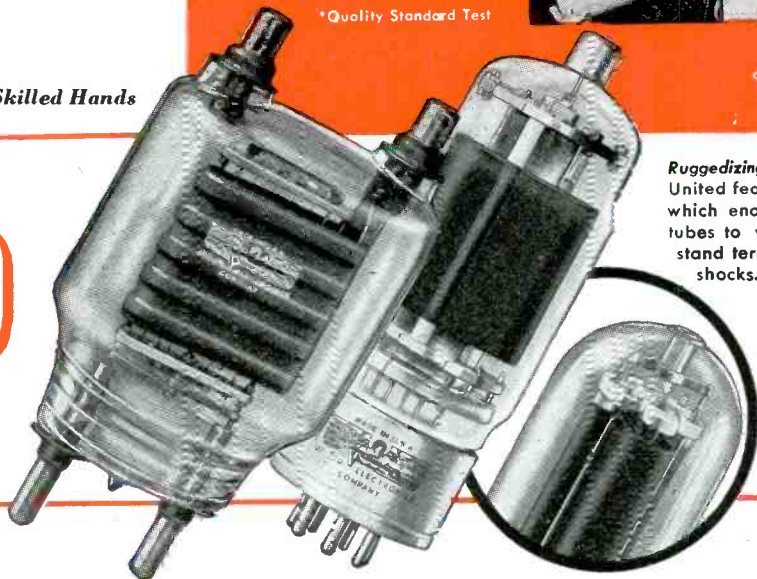

Ruggedizing: A United feature which enables tubes to withstand terrific shocks.

# SMALL But Stand-outs!



Manross tops the field in sensitive springs for instruments, gauges, relays, etc. Materials to suit your conditions of use—processed to give accurate, long-lived service. Sound design—carefully controlled production in any quantity.

## MANROSS *hair springs*

### F. N. MANROSS & SONS

DIVISION OF ASSOCIATED SPRING CORPORATION  
BRISTOL, CONNECTICUT

## PROJECTION C-R-O TUBE

(Continued from page 176)

field of high voltage surges seems to be particularly promising. Success at these extreme speeds depends naturally, not only on the tube performance, but also on certain factors such as lens speed, object-to-image ratio, film sensitivity, and development procedure. Because of the increased light output of the type 5RP tubes, the lens problem becomes less difficult, and for medium speeds, an f:3.5 lens is perfectly satisfactory. For high speeds, an f:2 or better lens may become necessary. Recognizing the importance of photographic recording, a complete series of photographic accessories including still and continuous motion cameras will be made available by Du Mont for these problems.

The high brilliance of the multi-band tube makes possible visual observation of very rapid phenomena which otherwise remain invisible. For most purposes, the 5RP1 tube is preferable, although it seems that in the case of extremely high writing rates, the P11 screen has somewhat higher efficiency. No definite data are yet available, and this question will be investigated further.

The study of slow phenomena is also expected to be facilitated by the increase of persistence on 5RP2 and 5RP7 tubes which are to be made available later.

## SYNCHRO CONTROLS

(Continued from page 83)

not actually be an electric motor but may be some other kind of electric device that causes a hydraulic system to function or it may actuate other electro-mechanical system which may in turn cause the rotor of the control transformer itself to turn.

Such systems are called positional servos, since an input angle on the rotor of the synchro generator will be followed up in position by the control transformer. The control transformer is driven by the servo motor which is, in turn, actuated by an amplifier that gets its signal from the voltage of the control transformer. Only when the control transformer voltage is zero will the servo motor be satisfied and stop. Of course, it is not necessary that it stop. The generator rotor may actually continue turning at some speed and then the servo will merely follow along.

It is beyond the scope of this article to go into the requirements of stability of the servo systems. Synchro systems, even the good ones, are not generally accurate to better than  $\frac{1}{4}$  deg. In some cases, with extreme precision, a little more accuracy can be obtained but the improvement is still not good

(Continued on page 184)

# HORN TYPE LOUD SPEAKERS

## WHAT ABOUT *Horn* LOUD SPEAKERS?

25¢

Jensen  
Technical  
Monograph



What effect do horn formula, flare and length have on low frequency "cut-off?" In the most commonly used frequencies which horn is most directional—one with large or one with small mouth? What are the advantages of the reflex type horn? How is a 500-watt "bull horn" constructed? What are the advantages of the new Hypex,\* originated by JENSEN, over the exponential type horn?

"HORN TYPE LOUD SPEAKERS"—JENSEN Monograph No. 5,—the latest number in the JENSEN Monograph series and now available, discusses simply and clearly these and many other questions pertinent to the study of electroacoustics. By means of photographs, diagrams and graphs it reviews the principles, performance characteristics and applications of horn type loud speakers and illustrates modern reproducers employing horns.

Get your copy of this or any others of the series today from your JENSEN jobber or dealer or from the JENSEN Technical Service Department. Price each 25c.

*Specialists in Design and Manufacture of Fine Acoustic Equipment*

**FREE** to men in the Armed Services, and to Technical Schools, Colleges and Libraries.



# Jensen

**Jensen RADIO MANUFACTURING COMPANY**  
6605 South Laramie Avenue, Chicago 33, Ill.

Send me the Monographs checked:

- (1) "Loud Speaker Frequency-Response Measurements"
- (2) "Impedance Matching and Power Distribution."
- (3) "Frequency Range in Music Reproduction."
- (4) "The Effective Reproduction of Speech."
- (5) "Horn Type Loud Speakers."

Send 25c  
for each  
book ordered.

Name \_\_\_\_\_

Address \_\_\_\_\_

City \_\_\_\_\_ Zone \_\_\_\_\_ State \_\_\_\_\_

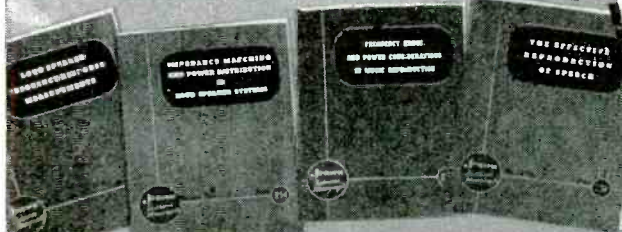

\*Trade Mark Registered; U. S. Patent No. 2,338,262

never look a gift horse  
in the mouth . . .

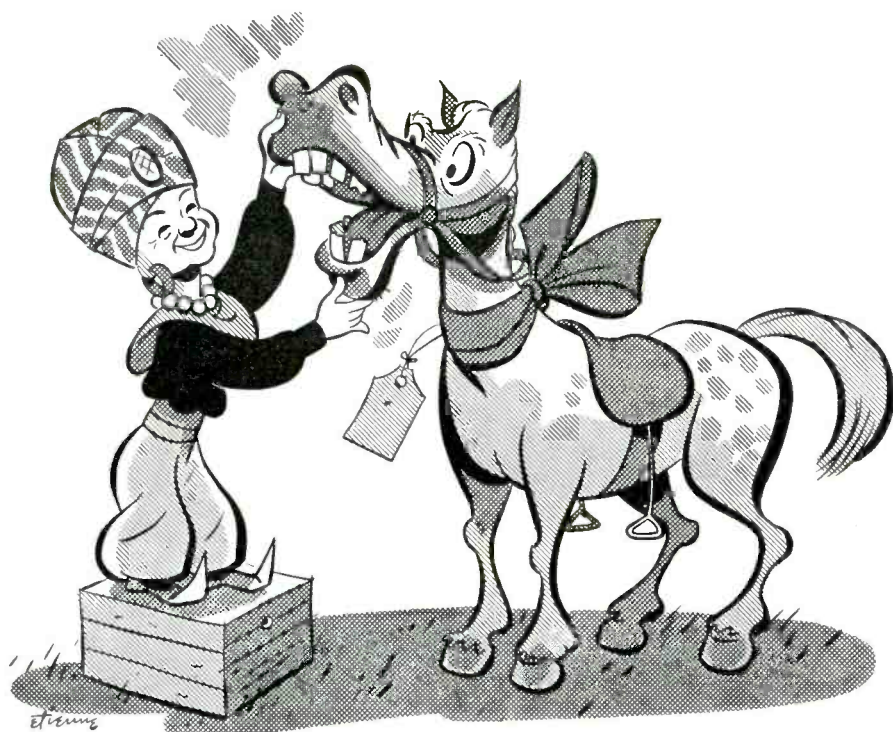

Courtesy may deny too close scrutiny of a gift but certainty demands detailed inspection of a purchase . . . as in the instance of mica. Be sure it is *Macallen Mica* . . . standard for more than 50 years!



When you think of MICA think of MACALLEN

**the Macallen Company**

16 MACALLEN STREET - BOSTON 27

CHICAGO: 565 W. Washington Blvd.

CLEVELAND: 1905 Leader Bldg.

**SPOT WELDING**

with a PAIR of

**TWEEZERS . . .**

*Remarkable*

SAY HUNDREDS of PRODUCTION  
ENGINEERS and TECHNICIANS,  
PLANNING INSTALLATIONS

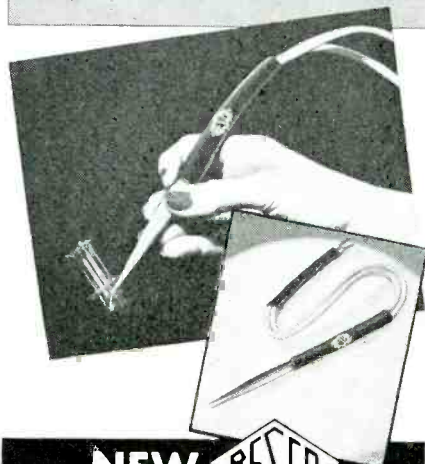

NEW **BESCO**

**SPOT WELDING**

**TWEEZERS\***

- Probes For, Bands, Holds, Welds Small Parts
- Connects to Present Spot Welding Equipment
- Reaches Almost Inaccessible Elements
- Operates on from 1/2 to 1 KVA on 10 Amp Current
- No Skill Required
- Minimum Maintenance
- Fast, Productive, Inexpensive
- No Oxidation, Clean Weld
- Welds Copper, Nickel, Steel, Tin, Tin Alloys, Brass, Monel, Zinc, Bronze, Nickel to Tungsten, Copper to Nickel

Already performing successfully for some of America's leading manufacturers, welding fine wires .003" OD and larger. Applications unlimited. Send along problems and samples for quick solution in our testing laboratory.

WRITE for COMPLETE  
CATALOG DATA  
NOW!

**NEW JERSEY JEWELER'S SUPPLY**

Manufacturers

280 Plane Street, Newark 2, N. J.

\*PAT. PENDING



# distinguished cabinet member

## on a secret mission...

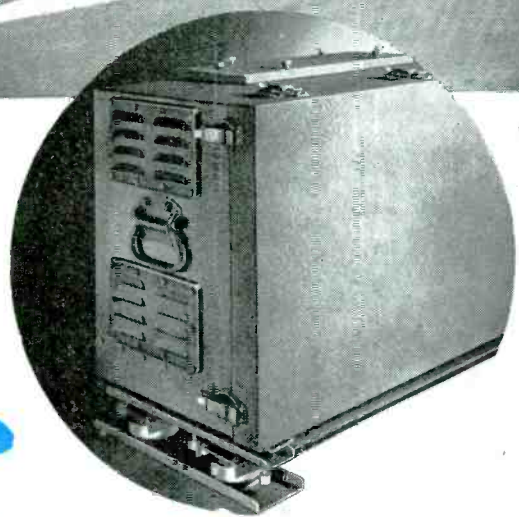
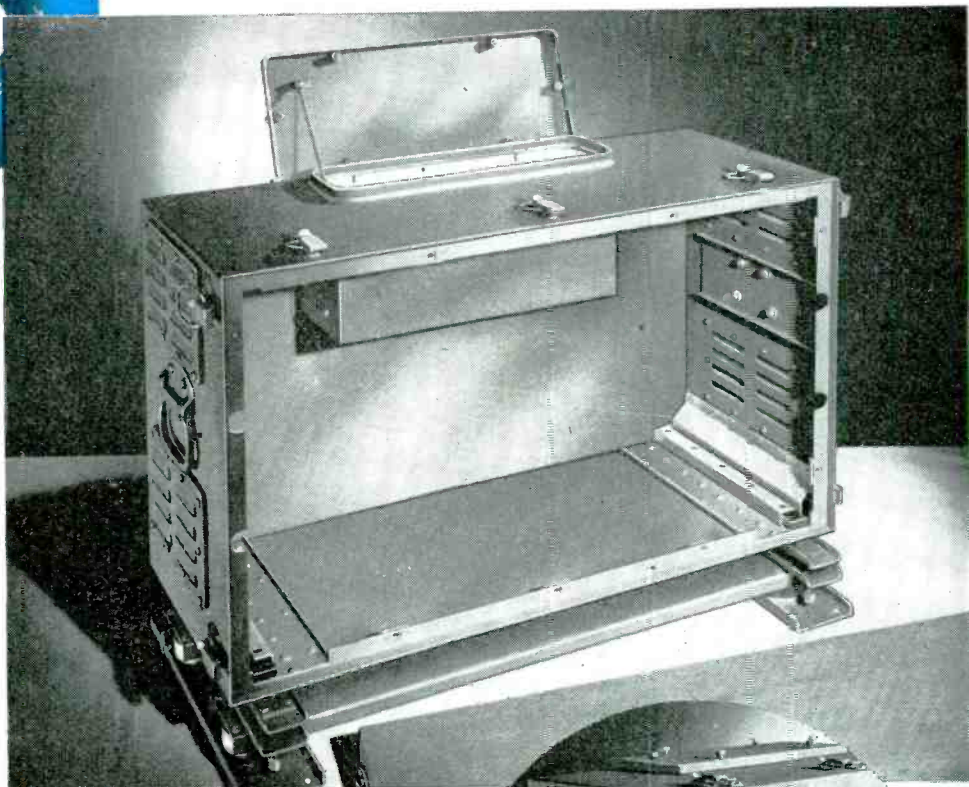

**T**he actual use of this Karp-constructed cabinet assembly for electronic apparatus is a military secret.

We can, however, reveal the superior details of the all-welded aluminum construction. It is splash-proof, insect-proof—and at the same time ventilated. The assembly also includes a shock mount. Suspension slides permit the electronic apparatus to move in and out like a drawer.

If you require special-built housings, racks, panels, chassis or enclosures for electrical equipment, get the benefit of our 20 years of specialized experience in this field. Our hundreds of skilled craftsmen will save your time. Our complete facilities and numerous stock dies will save you money.

**ANY METAL • ANY GAUGE • ANY SIZE • ANY FINISH**

# KARP

## METAL PRODUCTS CO., INC.

*Custom Craftsmen in Sheet Metal*

126-30th Street, Brooklyn 32, N. Y.



**Weigh a lot less!**

**Less subject to breakage!**

**Adaptable to any mounting style!**

**Exceptionally low dielectric loss!**

**TAP 'EM ANYWHERE!**

If desired, many types of B & W Air Inductors can be supplied with every turn indented as illustrated. This permits quick, easy tapping at any point!



**B&W**

**Air INDUCTORS**

**ALL SHAPES—ALL SIZES—for all jobs!**

In the ten years since B & W discarded conventional winding forms and started winding many types of coils "on air", these unique inductors have proved their marked superiority for a wide variety of equipment. AIR INDUCTORS weigh much less—are infinitely more adaptable to difficult design

and mounting specifications. Unexcelled for plug-in services, there is little about them to break—and, if desired, they can be protected from rough services with bumper rings. Dielectric loss is exceptionally low—and they can be wound to an exacting, uniform pitch. Tell us your coil needs!

**BARKER & WILLIAMSON**

DEPT. EL-95, 235 FAIRFIELD AVE., UPPER DARBY, PA.

Export: LINDETEVES, INC., 10 Rockefeller Plaza, New York, N.Y., U.S.A.

## SYNCHRO CONTROLS

(Continued from page 180)

enough to control many devices.

If the synchro units are not accurate enough directly, they can be used in a different way. If the synchro itself makes many turns for every time the gun or other controlled device goes around once, then the error of the synchro is diminished by the gearing ratio. The need for a two speed synchro system using "coarse" and "fine" synchros is very obvious. It is necessary, of course, to have a synchro that goes one to one with the driven shaft, because there would be N different positions that a high speed or "fine" synchro would pull into position, N being the gear ratio. On the other hand, when the desired position is obtained the control must go over to the fine synchro in order to get the required accuracy. In order to accomplish this condition, the coarse synchro must take over control if the error of the device increases more than  $\frac{1}{2}$  turn of the fine synchro.

There are naturally a number of ways of accomplishing this. For example, a relay could be connected to the coarse unit so that if the voltage of the coarse unit increased by a given amount the relay would disconnect the fine unit and connect the coarse unit causing the device to be driven to the zero position to within the limit of  $\frac{1}{2}$  turn of the fine synchro. This done the voltages would decrease enough so the relay turns the servo control back over to the fine synchro.

When such a system is used, there might be difficulty at the 180 deg. point if the high speed or fine synchro has an even number of turns or one turn of the coarse. Then when the voltage is zero on the coarse the fine synchro will cause the system to be stable and settle down at either the zero or at the 180 deg. point.

If, on the other hand, the fine synchro has an odd ratio then the point at 180 deg. on the coarse will be an unstable point on the fine and if the voltage on the coarse is low enough to turn the control over to the fine, the fine voltage will be such that it will cause the servo to drive away from the point if there is the slightest disturbance.

However, there are many systems used in which the fine synchro has an even ratio with the coarse. These cases require special attention. To illustrate a means of getting around this difficulty, Fig. 12 shows a six speed fine error voltage along with a one speed error voltage. Notice at the zero line down the center, the negative slopes on both the fine and on the coarse error voltage curves cause the servo to be stable

(Continued on page 188)

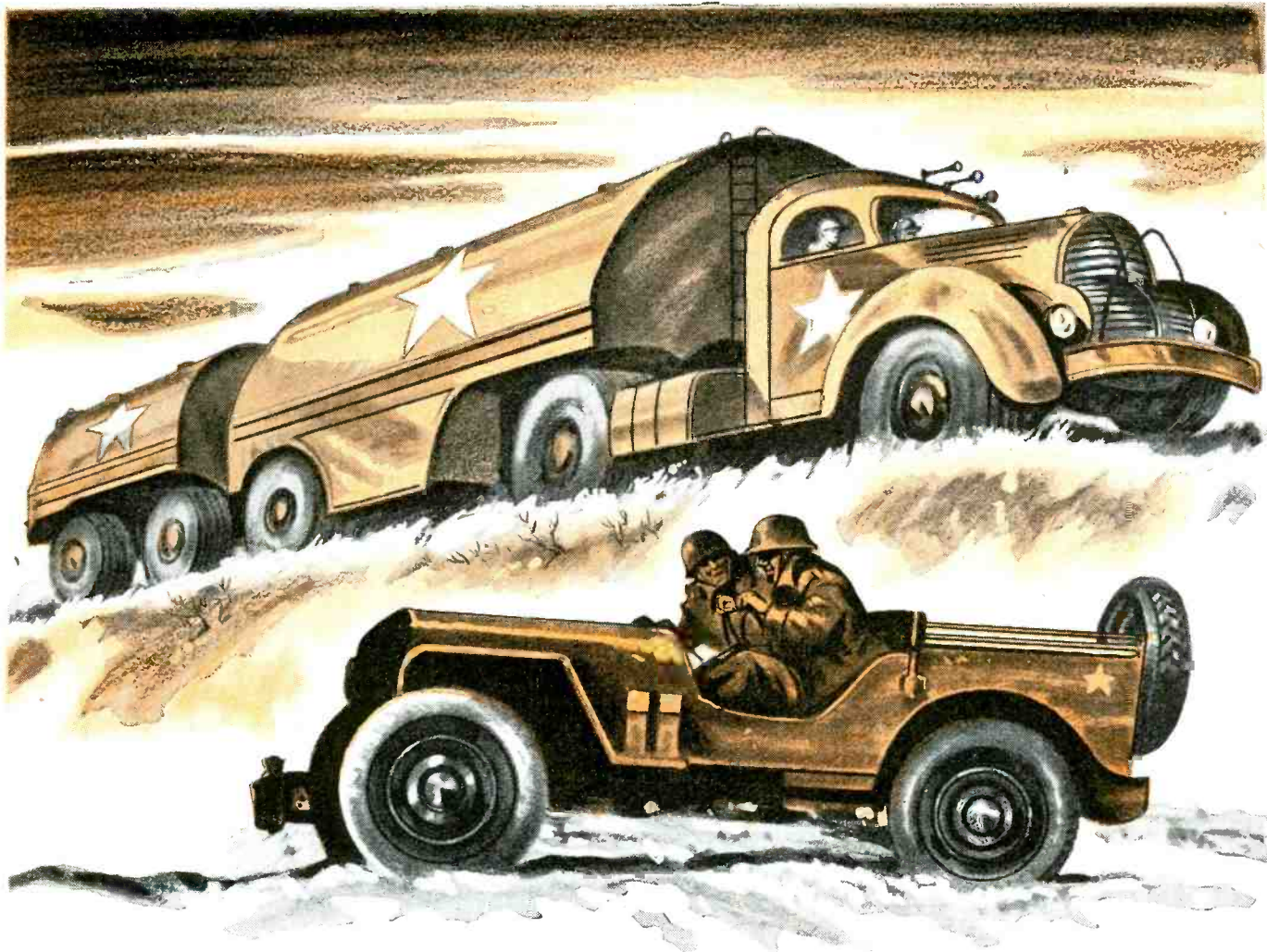

## SIZE IS EVEN *More* IMPORTANT IN WIRE!

Don't send a jeep on a tractor-trailer job or attempt to use "almost" the right wire. Spencer's constant control system guarantees that each coil,

spool or hank of wire (in alloy or steel) is exacting in size, tensile strength, physical and chemical requirements. Write today for complete information.

**BERYLLIUM-COPPER, PHOSPHOR BRONZE, NICKEL, HIGH CARBON AND STAINLESS STEEL WIRE IN SIZES FROM .001" TO .050"**



CONSULT SPENCER FOR EXACTNESS IN WIRE.

**SPENCER WIRE COMPANY**

WEST BROOKFIELD PLANT  
WEST BROOKFIELD • MASS.

Here it is . . .

the New 5th EDITION

of

# PRINCIPLES of RADIO

By KEITH HENNEY  
Editor, *Electronics*

INCLUDES NEW MATERIAL ON:  
 wave guides • velocity modulation tubes • frequency modulation, Klystrons • ultra high frequency techniques and apparatus • measuring instruments • magnetic circuits • **ADDITIONAL DATA ON Kirchhoff's laws • power factor • filter circuits • differentiating and integrating circuits • pulses • transients • square waves • voltage and current regulator tubes • filter design for power supply • tuning indicators • horn radiators • quarter- and half-wave transmission lines • magnetrons • vacuum tube voltmeters • cathode ray oscillographs.**

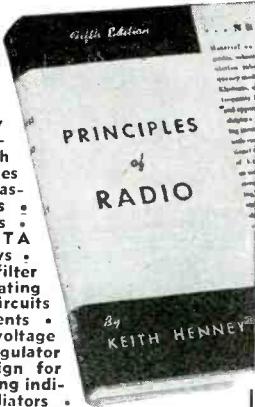

So popular has this book become that it has now gone into its FIFTH EDITION. This well-known book is designed for those with or without technical training in radio who want a working knowledge of the basis upon which radio communications exist. In simple, non-technical language, "Henney" starts with the fundamental principles of electricity, and gradually develops the subject of radio practice. Practical applications of theories are simplified by the specific examples, experiments, and problems, together with drawings, diagrams and photographs of actual apparatus.

1945 534 Pages Illustrated \$3.50

**JOHN WILEY & SONS, Inc.**  
440 Fourth Ave., New York 16, N. Y.

### ON APPROVAL COUPON

JOHN WILEY & SONS, INC.  
440 Fourth Ave., New York 16, N. Y.

Please send on ten days approval a copy of Henney's PRINCIPLES OF RADIO. At the end of that time, if I decide to keep the book, I will remit \$3.50 plus postage; otherwise I will return the book postpaid.

Name .....

Address .....

City and State .....

Employed by.....

E1-9-45

# Sheet Metal Fabrication

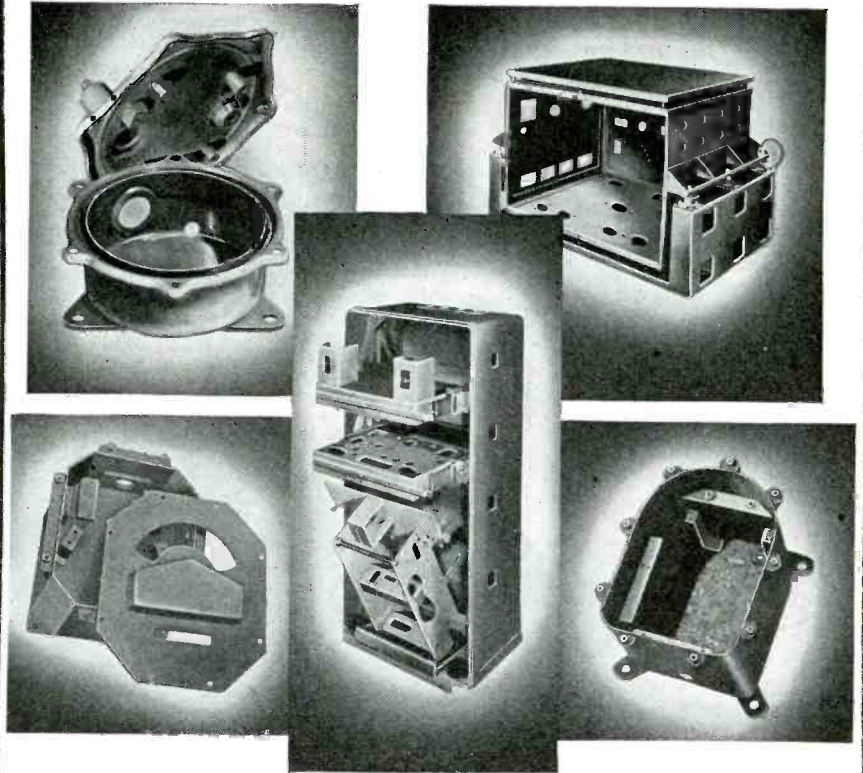

Whatever your problem...whatever your product  
 ...instrument housings, water tight boxes, chassis...  
 call on Cole Steel Equipment Company. Our years  
 of experience in-designing, fabricating, and finish-  
 ing are your assurances of "know-how" performance.

Send for our brochure

**"THE PLANT BEHIND YOUR PLANT"**

# COLE

**STEEL EQUIPMENT COMPANY**

349 Broadway, New York 13, New York • Factory: Brooklyn, New York

**COLE STEEL OFFICE EQUIPMENT**  
will again be available after the war

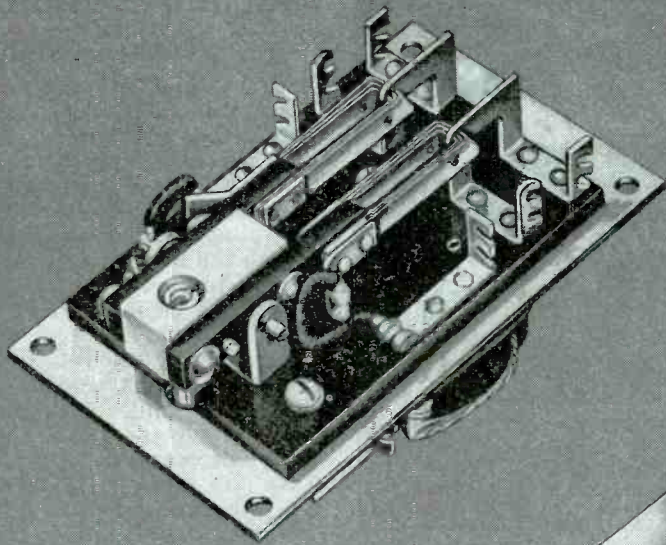

✓ **MAKE-BEFORE-BREAK CONTACT**  
 Action... eliminates transfer  
 "click" interferences or  
 circuit interruptions.

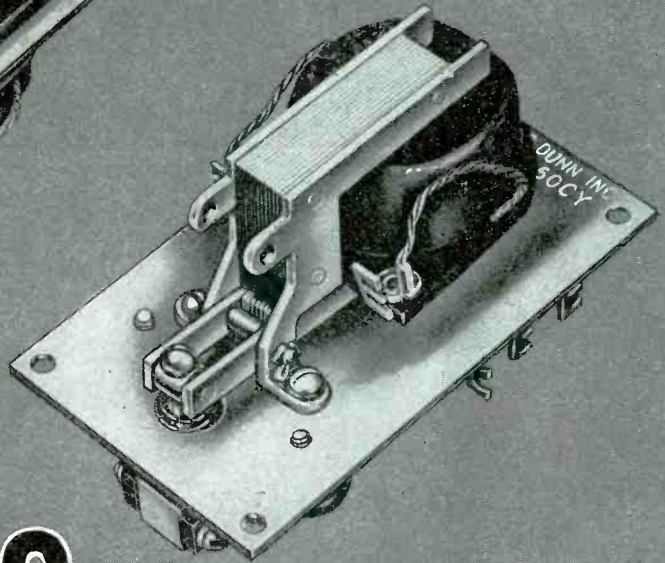

✓ **UNIQUE LAMINATED BRUSH TYPE CONTACTS**  
 ... Low and constant  
 contact resistance.

# 91XBX100 . . . . . DESIGNED FOR MICROPHONE AND THERMO-COUPLE SWITCHING CIRCUITS . . . and other extremely low power control applications

The Struthers-Dunn a-c operated Type 91XBX100 Relay has double-pole double-throw, make-before-break contacts that are especially designed for handling milli-volt, milli-ampere, and milli-watt loads. Each moving contact consists of six laminations. The long sliding motion of the six contact surfaces results in extremely low and constant contact resistance, thus assuring electrically smooth performance—a "must" in audio frequency or recording instrument switching circuits.

The metal mounting plate acts as a shield, isolating the magnetic structure from the contacts, minimizing the possibility of induced a-c hum in the contact circuits.

Operating coils are available for use on standard voltages up to 230 volts a-c, 60 cycles.

**DISTRICT ENGINEERING OFFICES  
 IN THESE CITIES TO SERVE YOU:**

ATLANTA • BALTIMORE • BOSTON •  
 BUFFALO • CHICAGO • CINCINNATI •  
 CLEVELAND • DALLAS • DENVER •  
 DETROIT • HARTFORD • INDIANAPOLIS  
 • LOS ANGELES • MINNEAPOLIS • MON-  
 TREAL • NEW YORK • PITTSBURGH •  
 ST. LOUIS • SAN FRANCISCO • SEATTLE  
 SYRACUSE • TORONTO



**STRUTHERS-DUNN, Inc., 1321 Arch Street, Philadelphia 7, Pa.**

# STRUTHERS-DUNN

## 5,312 RELAY TYPES

*Production AVAILABLE  
on special design transformers*

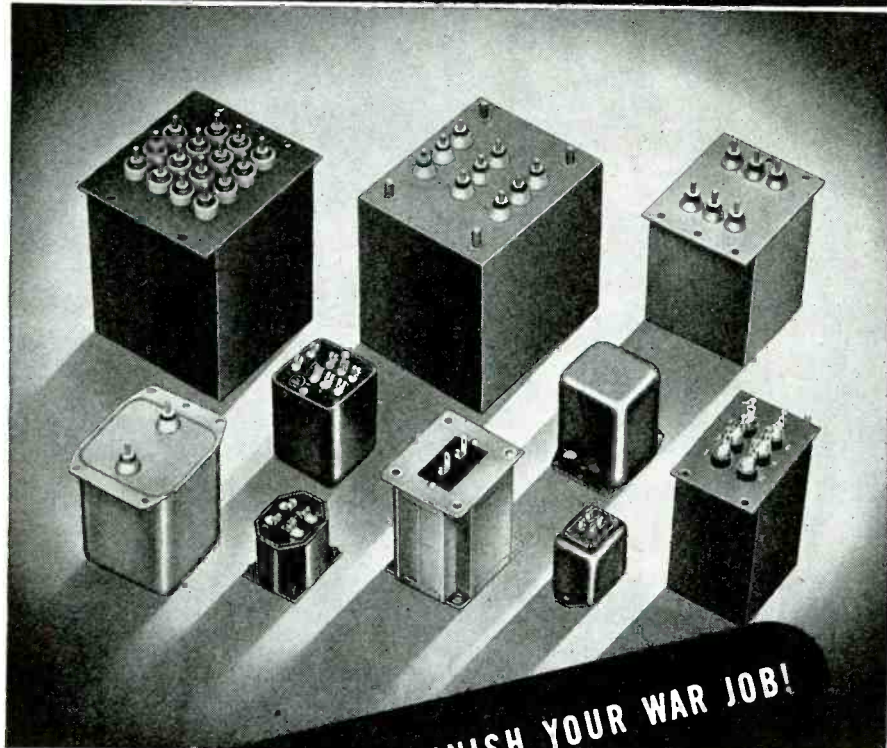

**LET STANCOR HELP FINISH YOUR WAR JOB!**

A limited schedule can be accommodated now for designing and manufacturing special transformers to your specifications. The same facilities and personnel which put Stancor in the front rank of war auxiliary producers — are still on the job and are your guarantee of top-flight engineering and production experience. Write enclosing specifications, or wire.

Incidentally that's a good thing to remember too for your future needs. Expert planning, modern equipment, precision winding machinery, special samples division with competent sales engineers—all will represent the highest efficiency in satisfying your most exacting transformer requirements.

**STANDARD TRANSFORMER CORPORATION**

1500 N. HALSTED STREET

CHICAGO 22, ILLINOIS



## SYNCHRO CONTROLS

*(Continued from page 184)*

or to seek and hold on those points. If the voltage is in the lower part, that is, has a 180 deg. phase from what we might say is zero phase, the servo will tend to turn toward the minus end or to the left, and if the voltage is what we call in phase (above the line), the servo will tend to turn to the right. Therefore, on the coarse error voltage the servo will seek the center line.

The part of the voltage curve of the fine at that point also has a stable zero point. Examine the fine error voltage at  $-180$  deg. and  $+180$  deg. The coarse synchro will try to drive the servo from these points but the fine synchro will try to drive it toward them. Now since the fine synchro must take over when the coarse voltage is low, it will turn over the synchro servo mechanism to the fine synchro at the 180 deg. point and it will be stable there but it has settled at what we call back or false zero.

One method of eliminating this trouble is to add to the coarse error voltage a fixed voltage called here stick-off voltage. When this stick-off voltage is added, the new voltage (taken along the dotted line as zero) now will not be zero at the old zero point but at the  $+180$  deg. point. If this voltage is selected right, the zero point will be 15 deg. off the 180 deg. points. The middle zero voltage point will be at  $+15$  deg. Now if we rotate the coarse synchro 15 deg., it will appear as the lower curve modified coarse error voltage. Notice that it intercepts the zero at the old zero on the fine. Since it intercepts the zero voltage at an unstable point on the fine both on the right and on the left, we have a system where, if a relay were used to insert the fine when the coarse error voltage was as small as, or smaller than the value at  $\frac{1}{2}$  turn on the fine, the system would not have an ambiguity at 180 deg. and would be stable only at the proper zero position.

Another way of mixing the fine error voltage and the coarse error voltage is to limit the fine error voltage by clipping it, as in Fig. 13. In that way the initial slope and accuracy of the fine synchro is maintained. When the error is  $\frac{1}{2}$  turn of the fine, the coarse voltage predominates over the clipped fine voltage and causes the servo to correct the zero. The combination of the clipped fine error voltage with the modified coarse error voltage is added up to the summation voltage in the lower curve. This will show that there is only one stable point in the system.

A further modification is to depress the coarse error voltage near the low or zero values so that it

*(Continued on page 192)*

Trailer-studio houses and transports  
Presto equipment in South Pacific.



Presto microphone picks up on-the-  
spot interview with fighter pilot.



Marines record Valentine messages for  
broadcast over U. S. radio stations.

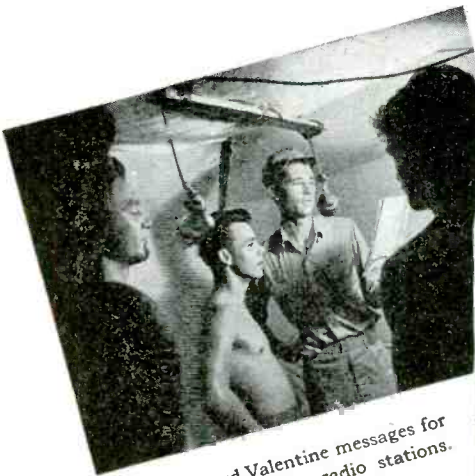

**THIS  
IS WHY YOU  
HAVEN'T BEEN ABLE  
TO GET A  
PRESTO RECORDER**

Because Presto equipment has  
been right there in the front lines  
with G.I. Joe...to support his  
strategy with actual combat  
transcriptions...to support his  
morale with recorded messages  
of his voice for the folks back  
home...and to give America a  
permanent, unprecedented sound  
document of a world-at-war.

South Pacific natives serenade U. S.  
listeners via Presto recordings.

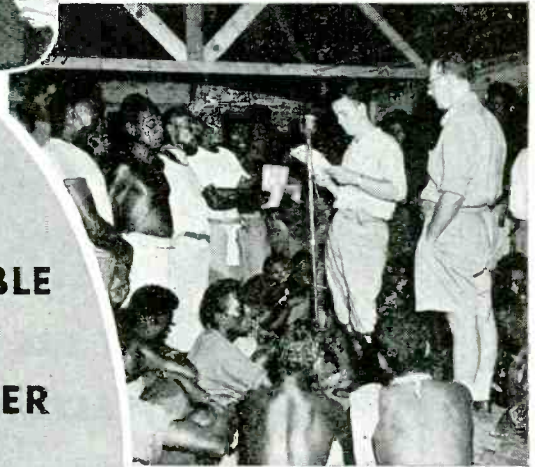

Presto transcribes battle experiences  
during Bougainville offensive.



At the front, Presto is standard equip-  
ment with the Armed Services.



Presto recordings carry Marines' greet-  
ings to their families at home.



# PRESTO RECORDING CORPORATION

242 West 55th Street, New York 19, N. Y.

Walter P. Downs Ltd., in Canada

**WORLD'S LARGEST MANUFACTURER OF INSTANTANEOUS SOUND RECORDING EQUIPMENT AND DISCS**

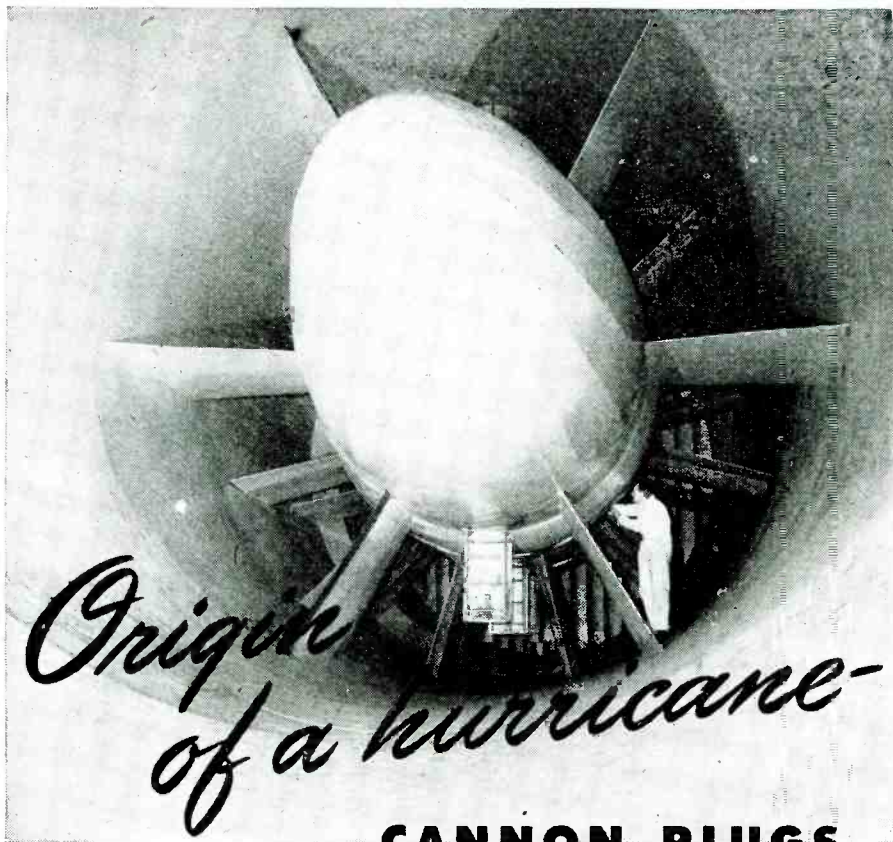

# Origin of a hurricane-

## CANNON PLUGS IN ALL CIRCUITS OF THE CALTECH WIND TUNNEL

One of the fans in the cooperative wind tunnel—owned by Consolidated Vultee, Douglas, Lockheed and North American—operated by the California Institute of Technology.

Two fans, each 21 feet 9½ inches in diameter, with a main drive of 12,000 hp. maximum, develop an air speed of over 700 m.p.h. in this new aircraft testing machine. Models are tested under air pressures ranging from one-quarter atmosphere to four atmospheres. Aerodynamic forces and moments are measured accurately, readings automatically recorded.

More than a thousand Cannon Connectors are employed in the electric circuits of the installation. Their use makes possible the quick and easy interchange of equipment, eliminates the duplication of costly instruments, increases the accuracy of the records taken.

Cannon Connectors, available in many thousands of standard capacities, sizes and types, may serve well in the circuits of the instruments you use or the products you manufacture. Write for a Condensed Catalog. Cannon Electric Development Co., Dept. A-122, 3209 Humboldt St., Los Angeles 31, California.



*Above:* Measuring dials recording forces and moments through control panel of Cannon Connectors. *Left:* Special Cannon Connector for portable control and recording unit. *Below:* Cannon Plugs used on measuring and recording machines designed and installed by International Business Machines Corporation.



## CANNON ELECTRIC

Cannon Electric Development Company, Los Angeles 31, California

Canadian Factory and Engineering Office:  
Cannon Electric Company, Limited, Toronto

Representatives in Principal Cities—Consult Your Local Telephone Book  
190

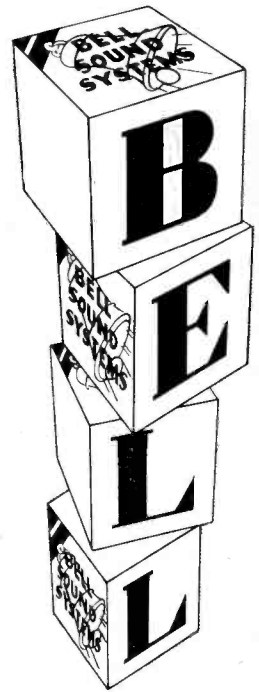

**You may want  
to build BELL  
electronic  
controls or  
assemblies into  
your post-war  
plans**

BELL may stack up perfectly—in both facilities and experience—as a source of electronic controls or assemblies to meet the needs of your post-war products or production. We'll gladly discuss the ABC's of electronics with you in terms of your specific problem. Why not write today?

**BELL PRODUCTS INCLUDE:**  
Electronic Sound Devices . . . Inter-communicating Systems . . . Industrial Voice-Paging and Broadcasting Equipment . . . Permanent and Portable Amplifying Systems . . . Recording and Disc Playing Units . . . Electronic Controls . . . Operating Sequence Recorders . . . Other Special Devices.



# BELL

**SOUND SYSTEMS, INC.**

1195 Essex Ave., Columbus 3, Ohio

Export Office:

4900 Euclid Ave., Cleveland 3, Ohio



# NO BUBBLE!

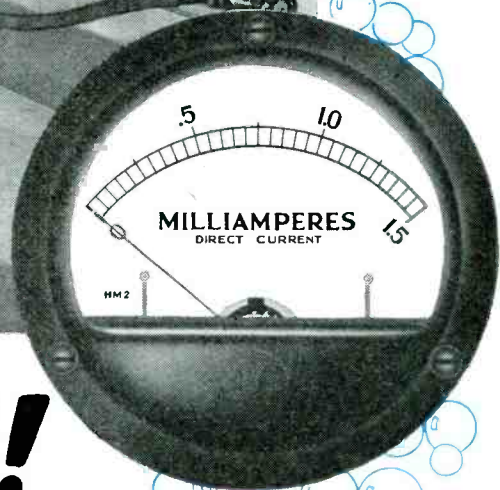

# NO TROUBLE!

**Production vacuum checking of Marion Glass-to-Metal Hermetically Sealed Electrical Indicating Instruments is no haphazard operation . . .** After sealing in our dehydrating rooms, the instruments are submerged in glass jars which are partially filled with alcohol. A vacuum of 25 inches is drawn in accordance with newest JAN-1-6 specifications. During the test we watch for air bubbles — no bubble means no trouble. Spot checks for a period of four hours are made in a 29 inch vacuum.

The testing apparatus, illustrated above, is a Marion development, and demonstrates our sincerity of purpose in producing hermetically sealed instruments. We take nothing for granted — we neither suppose nor assume. Because imperfectly sealed instruments entrap condensation, we make certain that every hermetic instrument bearing our name is — perfectly sealed.

**Marion Glass-to-Metal Truly Hermetically Sealed  
2½" and 3½" Electrical Indicating Instruments**

Write for our new, 12-page brochure. Manufacturers and users of radio and electronic equipment are invited to inquire into the advantages of Marion Glass-to-Metal Hermetically Sealed Instruments for postwar use.



**MARION ELECTRICAL INSTRUMENT CO.**

MANCHESTER, NEW HAMPSHIRE

Jobber Sales Division: Electrical Instrument Distributing Co.  
458 BROADWAY NEW YORK, N. Y.



## Something New for the **RECORD**

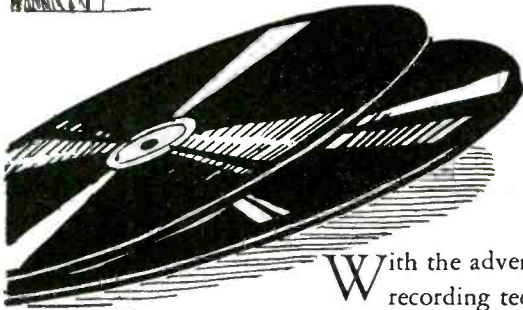

With the advent of new plastics and recording techniques, phonograph records of tomorrow will be pressed in finer-grain, noise-free materials. Recordings, however, can be no better than the pickup arm used in their reproduction. It remained for The Astatic Corporation, therefore, to design a new pickup with advanced characteristics equalling those of the new recordings. This has been accomplished by Astatic through improved featherweight action made possible with the introduction of vertical compliance and new damping materials. The greatest possible fidelity of sound reproduction from these advanced products, so dependent upon each other, will result, therefore, in an ever increasing measure of phonograph enjoyment. Production will begin when essential materials are made available.

**"You'll HEAR MORE  
from Astatic"**

ASTATIC Crystal Devices  
manufactured under Brush  
Development Co. patents.

**THE**  
**Astatic**  
**ASTATIC CORPORATION**  
CONNEAUT, OHIO  
IN CANADA, CANADIAN ASTATIC LTD., TORONTO, ONTARIO

## SYNCHRO CONTROLS

(Continued from page 188)

does not interfere with the operation of the fine error voltage at synchronism. A circuit for mixing these two voltages is shown, Fig. 14, utilizing the principle that both copper oxide and selenium rectifiers have the property of having a high resistance for low voltages across them and lower resistance as the voltage increases. Placing two of these units back to back across the fine error voltage will cause clipping. If, however, they are connected in series, as here in the case of the coarse error voltage, the voltage will be suppressed at low values because of the high series resistance. There are other ways, of course, of mixing fine and coarse voltages.

In the matter of servo amplifiers we will suggest some of the things necessary to consider. A common procedure in a servo system is to detect or demodulate the error voltage, as in Fig. 15. This demodulation must be phase sensitive: if the voltage from the control transformer rises it is required to know which phase causes the rise because the servo motor must go in one direction in one case and the other direction in the other. The reason for demodulation is that in order to stabilize the servo system it is necessary to have derivatives and integrals of the error voltage. That means that the rate of change of the ac voltage must be measured. One method of doing this, of course, is to demodulate the voltage and pass it through a differentiation network.

Diagrams of a few of the common demodulator circuits will naturally suggest other possibilities. The first, and probably the simplest, is the half-wave diode demodulator, Fig. 16, where a fixed ac voltage is impressed on the diodes. The currents from this source cause no unbalance across the output resistors. The error voltage coming through a transformer will add to or subtract from one side or the other and cause a dc unbalance in output resistors. This unbalance has a polarity depending on the phase of the error voltage.

Another common circuit is the half-wave triode demodulator, Fig. 17. Here the ac error voltage is placed on the grids of the two triodes, the plates of these triodes being excited in phase with ac. Current flows only when the plates are positive. If one of the grids is plus and the other is minus then one triode will carry more current than the other. It is half-wave since the tubes operate only on alternate half cycles.

Another common circuit or demodulation is the full-wave triode

(Continued on page 194)

# THOROUGHbred - j.g.

## THE BENDIX TG-16 FIXED STATION TRANSMITTER

*Traditional Bendix quality in the  
low power field.*

*The latest addition to the Bendix  
line of ground station equipment*

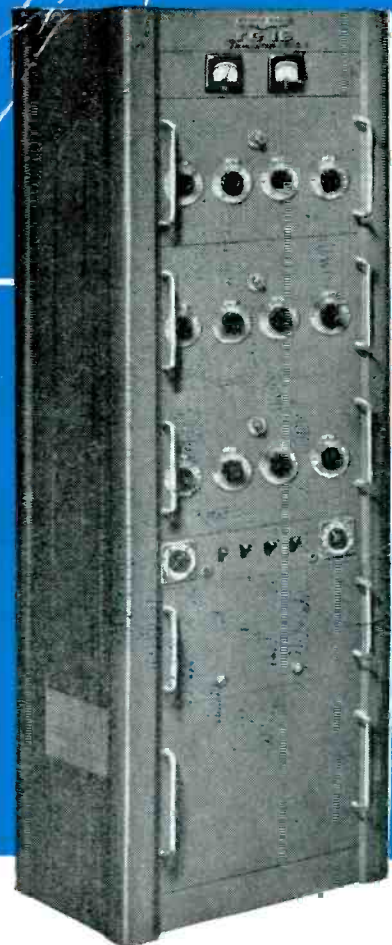

A worthy companion to higher powered Bendix equipment, the TG-16 transmitter is designed to the same standards of performance that have made Bendix Radio equipment "STANDARD FOR THE AVIATION INDUSTRY." Characterized by straightforward design, conservative ratings, and low power consumption, it is ideally suited for installation at secondary airfields where simple, reliable operation is a necessity.

The TG-16 is a unit-type, multi-channel transmitter for airways communication and point-to-point operation at

high frequency and V.H.F. A low frequency RF channel for control tower or automatic radio beacon service can be supplied where required. The output of the transmitter is 100 watts at V.H.F. At lower frequencies it supplies 190 watts for radio telegraph and 160 watts for radio telephone. Simple remote control facilities are available for distances up to 1000 feet.

For further information on the new Bendix TG-16 Fixed Station Transmitter, write for your copy of our catalogue.

*Listen to "MEN OF VISION" Sundays 7 P.M. E.W.T. CBS.*

# **Bendix** Radio **DIVISION**

BALTIMORE 4  MARYLAND

**STANDARD FOR THE AVIATION INDUSTRY**



# WHICH "MEGGER" INSULATION TESTER

## is Best for You?

THE "Megger" line of instruments for testing electrical insulation is complete for ranges from a fraction of an ohm to 10,000 megohms, between which limits practically every insulation resistance measuring requirement falls. There are specific instruments for specific requirements and other types for more general use. Some users find one instrument suitable for all work, while others have use for several types.

If you are uncertain which type and range of "Megger" instrument is best for your particular needs, write us, telling the type, size and rating of your equipment. We will gladly make recommendations. Write also for *Pocket Manual of "Megger" Practice*, No. 1420-EI.

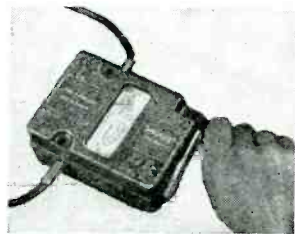

The New U. S.-Made Midget "Megger" Tester—In many ways the most remarkable "Megger" instrument ever built. Weighs only 3 lbs.—will fit an overcoat pocket or tool kit. Reads up to 50 megohms. Generates 500 volts and is always ready for use anywhere because of the hand crank. Bulletin 1785-EI.



The U. S.-Made "Megger" Insulation Tester—Contains the usual "Megger" direct-reading true ohmmeter, of the permanent magnet moving coil type, mounted with a d-c hand generator in a plastic molded case. Ranges up to 2000 megohms, with hand generators up to 1000 volts. Widely used in hard service. Variable-pressure ("Meg") and constant-pressure ("Super-Meg") types. Bulletin 1735-EI.



The "Bridge-Meg" Resistance Tester—This instrument is a combined "Megger" Insulation Tester and a four-dial, multi-ratio Wheatstone Bridge. Will measure any ohmic resistance from .01 ohm up to 100 or 200 megohms; hand generators rated up to 1000 volts. A complete and compact unit that is ideal for power companies and industrial plants. Catalog 1685-EI.



High-Range "Megger" Testing Set—The original heavy-duty type "Megger" Testing Instrument. Made in all ratings up to 10,000 megohms and 2500 volts. A combination high-potential testing and insulation resistance measuring set. Hand- and motor-driven types. Catalog 1685-EI.

## SYNCHRO CONTROLS

(Continued from page 192)

demodulator Fig. 18. Here the error voltage is applied to the grids of four triodes. The triodes have ac on their plates such that two of the plates are plus while the other two are negative. There is no ac unbalance across the output, providing the triodes are all the same and there is no error voltage applied. If an error voltage is applied to the grids there is a dc unbalance because one of the conducting tubes draws more current than the other. This action takes place in such a way that the output is a full-wave sinusoidal voltage. Less filtering is required in a full-wave demodulator and, therefore, less delay is incurred. This is very often of primary importance in servo systems.

## TELE VS. FOLIAGE

(Continued from page 90)

on the effect of foliage in making marked differences in television reception between winter and summer conditions—as well as remedies which have cured this difficulty of poor summer reception.\*

In the case of the television set operated by the Electronic Industries editor in Connecticut, 30 miles from New York City, a partial remedy which now gives fair reception on all local stations, has been found by two expedients:

1. Raising antenna structure 10 ft. (should have been raised 40 ft. to restore same relationship as before, since tree tops in this area measure 35 to 40 ft. above ground, but 10 ft. is limit of present structure).

2. Providing separate sets of dipoles tuned to each New York station, with separate leads down to the set. With the weak fields available during foliage months, each station comes in strikingly best on its own special-length antenna. Sometimes a slight additional pick-up can be gained by paralleling such antenna with the next nearest other dipole. Such a combination of three or four antenna leads, involves considerable switching of antennas when the set is dialed from one station to another, and so is not recommended for family use. But special antennas will provide acceptable television reception where none existed with a single "average" dipole for those stations not closely tuned to its frequency.

Experience so far adduced, indicates that loss of picture quality during summer months must be expected by suburban set owners in wooded areas where the incoming signals flow nearly parallel to the ground. Both the television trade and the public should have this ex-

\*See also "Television Service Hinges on Frequency," *Electronic Industries*, December, 1944, page 102.

(Continued on page 198)

**JAMES G. BIDDLE CO. • 1211-13 ARCH STREET  
PHILADELPHIA 7, PA.**

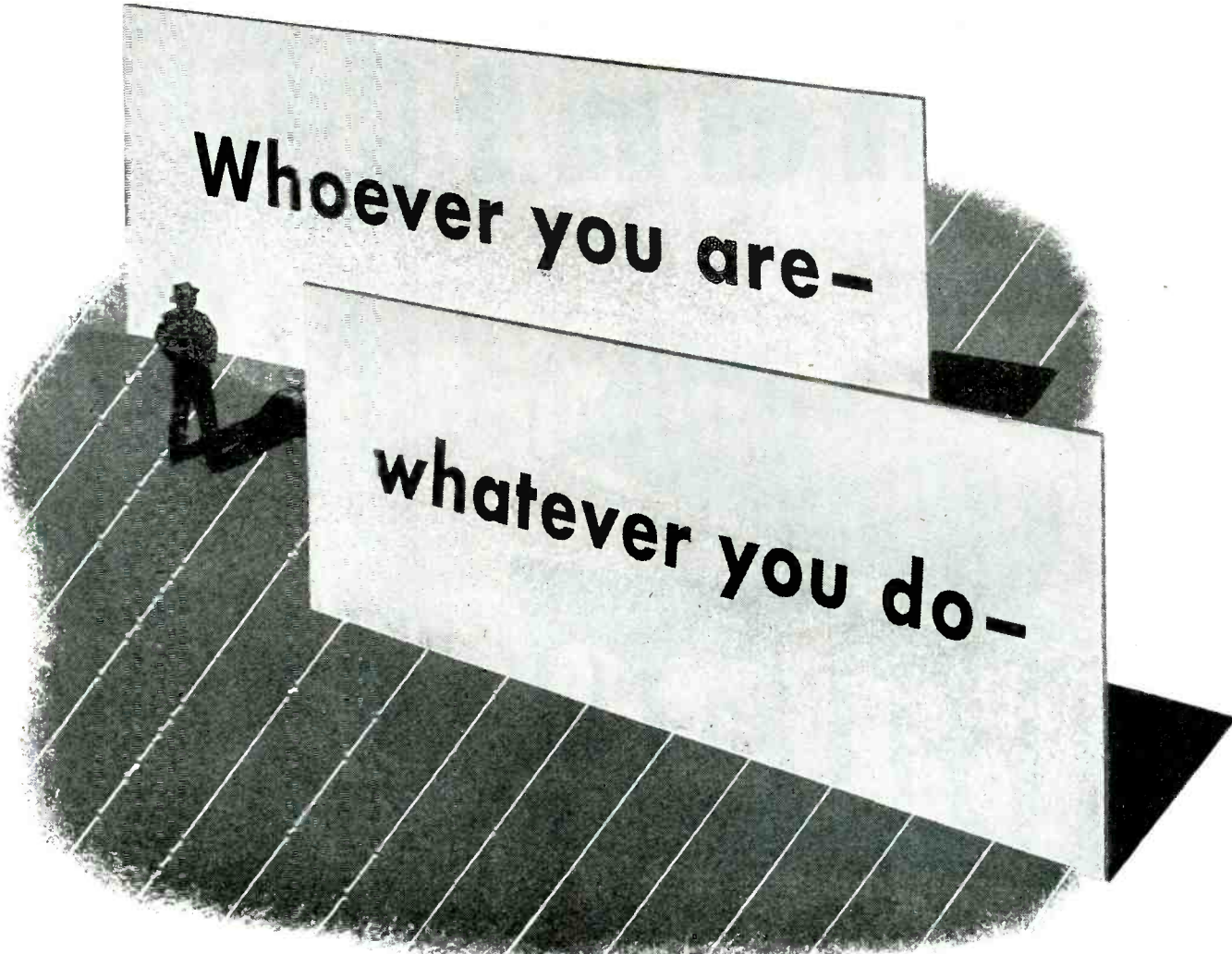
A large, white, rectangular sign is positioned on a dark floor with a white grid pattern. A person in a dark uniform and hat stands to the left of the sign, looking towards it. The sign is tilted slightly to the right. The text on the sign is in a bold, sans-serif font.

Whoever you are—

whatever you do—

## YOU NEED **hallicrafters** EQUIPMENT *in high frequency development work*

A black and white photograph of a Hallicrafters radio receiver, Model S-36, is shown. The receiver is a rectangular box with several dials and knobs on its front panel. A white sign is attached to the top of the receiver, with the word "hallicrafters" in a stylized font and "RADIO" in a simpler font. The sign is tilted to match the perspective of the receiver.

hallicrafters RADIO

• The new Hallicrafters AM/FM receiver, Model S-36, designed for maximum performance on the very high frequencies. Provides continuous frequency coverage from 27.8 to 143 Mc. Covers old and proposed new FM bands.

Rail and motor lines, maritime services and universally expanding aviation are planning new or improved communications systems to keep up with the forward pace. In these and many other fields of science there is an urgent demand for the latest developments in very high frequency and ultra high frequency apparatus. In your work in these fields, look to Hallicrafters for advanced communications and electronics equipment.

COPYRIGHT 1945 THE HALLICRAFTERS CO.



BUY A WAR  
BOND TODAY!



THE HALLICRAFTERS CO., MANUFACTURERS OF RADIO  
AND ELECTRONIC EQUIPMENT, CHICAGO 16, U. S. A.

# Conant

introduces...

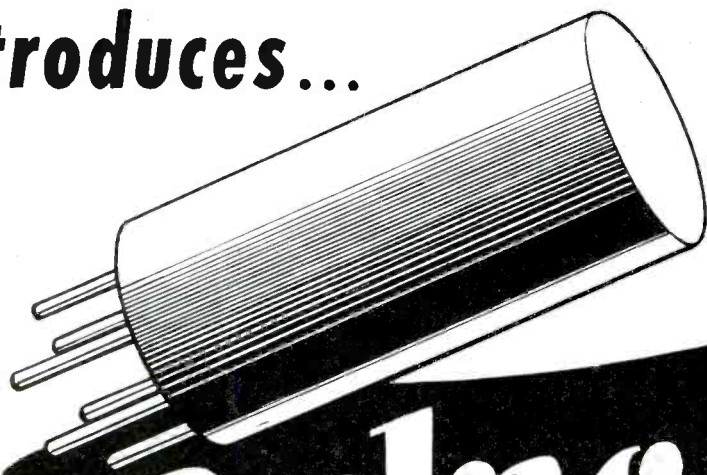

# Balac

*\*Instrument Rectifier and Balanced Resistance network all combined in convenient plug assembly*

Here is a brand-new development by Conant to meet the demand for applications involving the balanced bridge principle in AC operation.

Example: The conversion of standard Wheatstone bridge instruments to AC. In such applications, the AC accuracy and performance are equivalent to DC operation on the same instrument. Null indication is not affected by temperature, frequency, wave form or line voltage fluctuations.

This is but one of the multitude of uses for BALAC (trade mark—patent applied for).

Write or wire today for detailed information.



*Instrument Rectifiers*

**ELECTRICAL LABORATORIES**

6500 O STREET, LINCOLN 5, NEBRASKA, U. S. A.



## BE WITH YOU IN A MINUTE—

The Insuline Corporation is still 80% in war production. In fact, it has received its third Army-Navy Award, and is out to earn a fourth. Still the ICA Plant is geared to swing into full peace-time production almost instantly.

The radio industry, planning for the post-war market, will want to investigate the now-famous line of battle-tested ICA Auto Antennas. Careful engineering makes them rattle-proof; all-brass construction makes them rust proof.

A catalog, detailing everything that's news in antennas designed for the post-war market, is available. Ask for Catalog No. AA-216

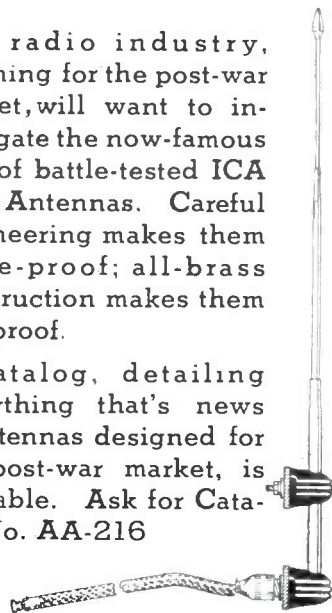

**INSULINE**  
CORPORATION OF AMERICA

*Quality Products Since 1921*

**INSULINE BUILDING**  
LONG ISLAND CITY, N. Y.

20 Vesey St., New York 7, New York  
85 E. Gay St., Columbus, Ohio  
600 S. Michigan Ave., Chicago 5, Ill.  
1215 Harmon Pl., Minneapolis 3, Minn.

2017 Grand Ave., Kansas City 8, Mo.  
1212 Camp St., Dallas 2, Texas  
378 Boulevard N. E., Atlanta, Ga.  
4018 Greer Ave., St. Louis, Mo.

1526 Ivy St., Denver, Colo.  
4214 Country Club Dr., Long Beach 7, Cal.  
Export Div., 89 Broad St., N. Y. 4, N. Y.  
50 Yarmouth Rd., Toronto, Canada

# RELAYS

**Model 1200.**  
(For DC operation.) Quick action available with contact ratings up to 10 amp., DC. Either quick or time delay action, normally open or closed.

**Model 1040.**  
(For AC operation.) Quick action available with contact ratings up to 50 amp., A.C. Either quick or time delay action, normally open or closed.

## READY, PROMPT TO PERFORM

Under the most exacting conditions . . . heat or cold, dirt, dust or moisture . . . Adlake Plunger-type Relays are ready on the job. Their mechanism, encased in armored glass or metal cylinders and then hermetically sealed, is impervious to the elements and oxidation.

Adlakes are prompt to give instant contacts, clean break-offs, because they use fast-moving, liquid metal mercury . . . positive in operation; silent and chatterless; will not burn, pit or stick. Yes, Adlake Relays have snap action that stays snappy . . . absolutely no tendency toward lazy, snail-pace motion.

No other relays are as simple, rugged, dependable. For timing, load or control circuits, you can design them into every kind of equipment and be assured of continuous, trouble-free service.

There's an Adlake Relay for all needs. May we suggest the type best suited for yours? Write for free bulletin.

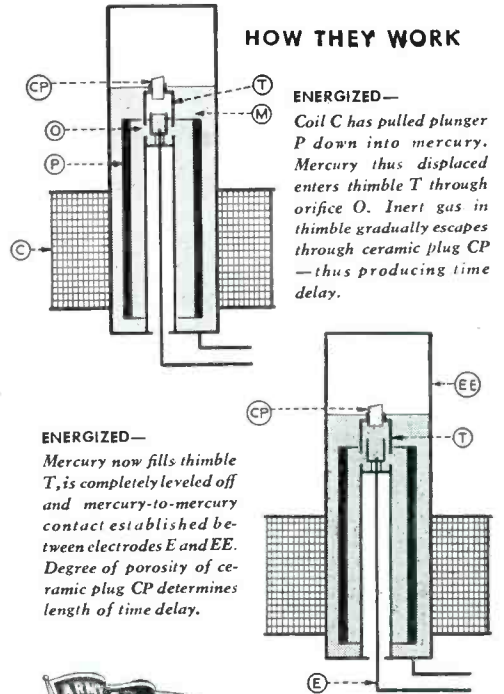

# THE ADAMS & WESTLAKE COMPANY

ESTABLISHED IN 1857

ELKHART, INDIANA

NEW YORK · CHICAGO

MANUFACTURERS OF ADLAKE HERMETICALLY SEALED MERCURY RELAYS FOR TIMING, LOAD AND CONTROL CIRCUITS

# Joint Army-Navy R93 Specification COMPARATIVE DATA

TYPE  
1196

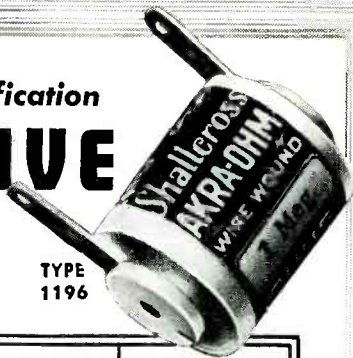

JAN Style Numbers RB	JAN Power Ratings Watts	Shallcross Type Numbers	Shallcross Power Ratings Watts
RB10	0.25	173 176*	0.25 0.25
RB11	1/3	183 183-A 186*	0.5 0.5 0.5
RB12	0.5	193*	1.0
RB13	0.5	196 1196**	1.0 1.0
RB14	1.0 1.0	116 1110**	2.0 2.0
RB20	0.75	100	1.0
RB21	Suggest JAN 20 or JAN 22		
RB22	1.5	110	2.0
RB40	0.4	120	0.25
RB41	0.5	140	0.5
RB42	0.6	160	1.0
RB51	0.25	181-A	0.5

NOTE: \* Indicates Maximum JAN Dimensions.  
\*\* Indicates Hermetically Sealed Resistor.

## TELE VS. FOLIAGE

(Continued from page 194)

plained to them in advance, in order to understand and avoid the embarrassment which will occur when picture quality gets poor from April to October.

Eventually, of course, with higher station powers and more stations, this difficulty with foliage blocking will undoubtedly disappear or be minimized. But during the early years of the coming television boom it may cause a lot of trade and manufacturer headaches until the difficulty is remedied in each instance by such local adjustments as can be made.

## NOMOGRAPH

(Continued from page 91)

The nomograph can be used to determine the power factor and Q of various dielectric materials and capacitors by the following means. The capacitor jig is built up with sufficient plate area to give at least 20 or 30 micromicrofarads for the usual type of Q meter. The capacitor should be so built that the insulation is as perfect as possible and so that the only losses which will occur in the capacitor will be due to the dielectric materials inserted between the plates. The Q meter is then set up resonant to the frequency at which tests are to be made, then the readings of  $C_1$  and  $Q_1$  are obtained. The test capacitor with the dielectric sample inserted is connected across the terminal and  $Q_2$  and  $C_2$  determined. The  $Q_x$  of the test capacitor can then be determined using the nomograph as previously described.

The power factor which can be very near the correct value for the dielectric sample alone, is  $1/Q_x$  whenever  $Q_x$  is greater than 10. For  $Q_x$  equal to 10 the power factor is in error by only 1 per cent. For greater values of Q the error decreases. The test capacitor jig needs to be quite rugged and good contact between the plate and dielectric sample are necessary to give readings which duplicated.

## RADAR GLOSSARY

(Continued from page 93)

turn, followed by an exponential curve.

**Error voltage**—A voltage, usually obtained from a selsyn, the magnitude of which is proportional to the difference between an actual position and a desired position. This voltage controls a servo system so that the resultant motion tends to reduce the error in position.

**E-scan**—A modification of B scan. Signal appears as a bright spot with range as the horizontal coordinate and elevation as the

(Continued on page 210)

## JAN R93 and SHALLCROSS Akra-Ohm

### Accurate Fixed Wire Wound RESISTOR TYPES

Write today for Shallcross Resistor Engineering Bulletin R giving full details on Akra-Ohm Resistors for every need and including mounting and terminal designs; dimensions; power dissipation; resistance alloys; moisture and fungus-proofing and hermetic sealing data; temperature coefficient of resistance and maximum resistance charts.

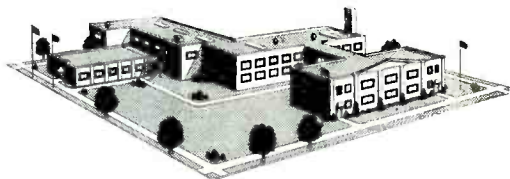

# SHALLCROSS MFG. CO.

Engineers • Designers • Manufacturers

DEPT. EI-95. COLLINGDALE, PA.





# Planning an improved product?

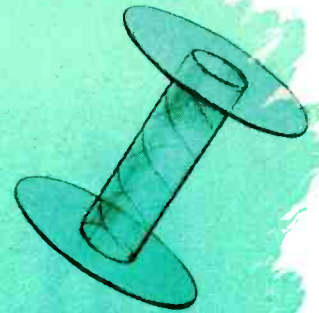
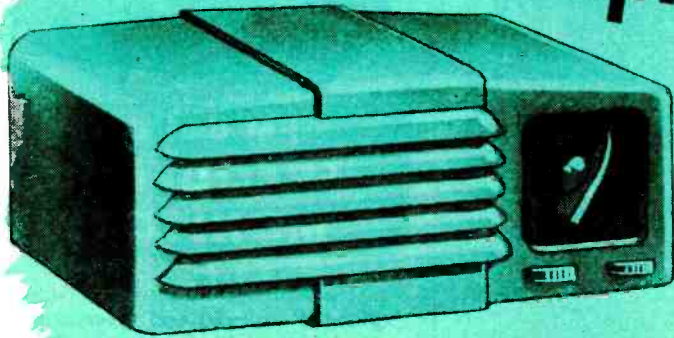

## Take advantage of Celanese\* custom-built Plastics

**Do you know** . . . that Celanese produces a flame-resistant thermoplastic (LUMARITH XF) with the high speed molding qualities of standard cellulose acetate? . . . that dial faces, covers, transparent shields and bezels can be molded to optical clarity from LUMARITH XZ? . . . that LUMARITH EC offers sub-zero toughness, warpage resistance, lightness and excellent moldability, all in one composition?

THESE are but a few of the new developments in Celanese cellulosic thermoplastics that soon will be available for civilian use. The war service of Celanese plastics include some of the toughest jobs thermoplastics have ever tackled: *aircraft control wheels molded over metal, corrosion resistant film insulation, interchangeable flashlight parts for arctic use, waterproof packaging of precision electrical parts, flameproof cable grommets for naval use, close-tolerance gas mask parts, instrument housings . . .*

These wartime applications tell a story of thermoplastic versatility that has important implications for the designer and manufacturer. Certainly, your plans for an improved postwar product will call for the best plastic available. We suggest that you take advantage of the war experience data collected by our technical staff. It will show you what you can expect plastics to do for you, and most likely indicate how production costs can be lowered.

## LUMARITH\* PLASTICS

MOLDING MATERIALS . . . FILMS  
FOILS . . . SHEETS . . . RODS . . . TUBES

\* Reg. U. S. Pat. Off.

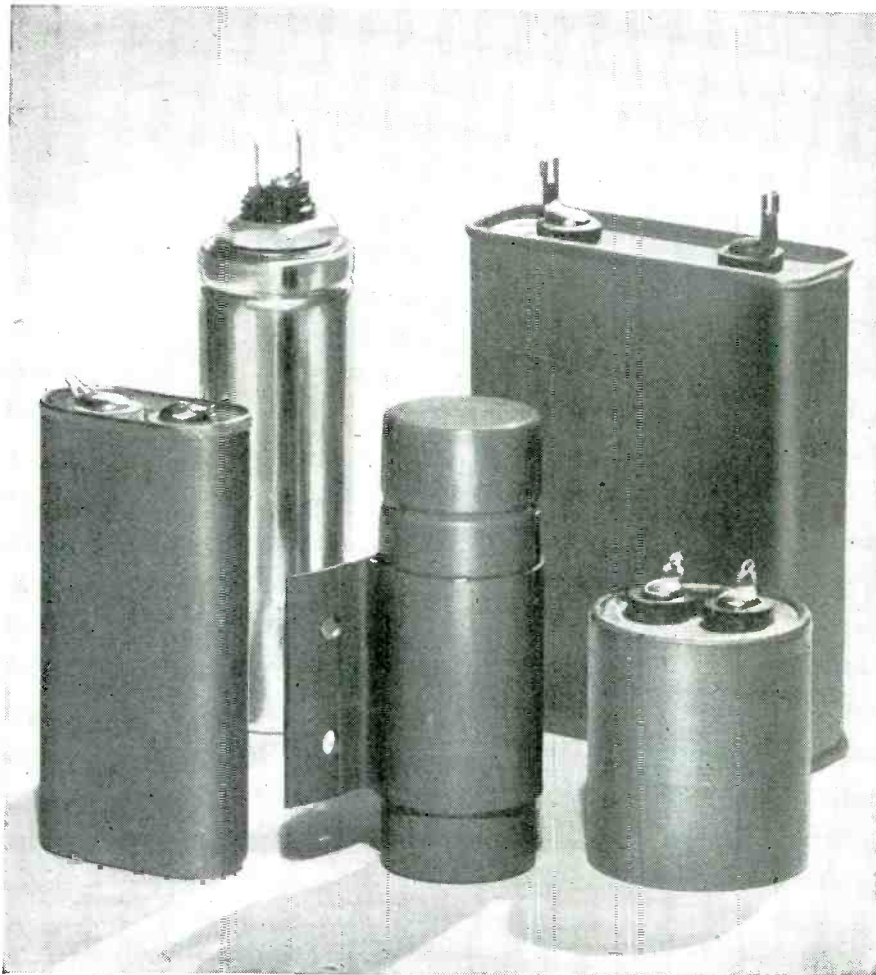

# Quality...

## A Success Secret of CAPACITRONS

The Capacitron reputation for progressive design, superior craftsmanship and dependable service is backed by a continuous research program covering every capacitor manufacturing operation. No Capacitron production process is ever given a chance to become "standard procedure" — it is always an engineering project — always open for immediate improvement. Through this system of *method control* has come unquestioned leadership for Capacitron Oil, Wax and Electrolytic Capacitors . . . our customers call it Quality.

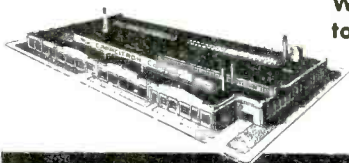

Telephone VAN Buren 3322

**The CAPACITRON Company**  
849 North Kedzie Ave., Chicago 51, Illinois

Engineered and built by

*Doolittle*



### FM and AM FREQUENCY MONITORS

*Direct reading.* No charts or complicated calculations necessary. Models available for 110 volt A.C. or battery operated portable use. Meet FCC requirements.



### DISTORTION METER

*Direct reading device* which indicates as a percentage of the fundamental frequency, the square root of the sum of the squares of the harmonic components. It is used for audio frequency measurements in any audio device in the usual range of voice or musical notes from 150 to 15,000 cycles.

• Utilize the many advantages of these units now. They are sturdily built, self-contained, moderately priced. Remember . . . equipment pioneered by DOOLITTLE years ago, *still serves efficiently today!*

SEND FOR FULL DETAILS

*Doolittle*

RADIO, INC.

7421 SOUTH LOOMIS BOULEVARD  
CHICAGO 36, ILLINOIS

BUILDERS OF PRECISION  
RADIO EQUIPMENT

# WILCO

## Now EQUIPPED

for large scale production of

# JACKETED WIRE

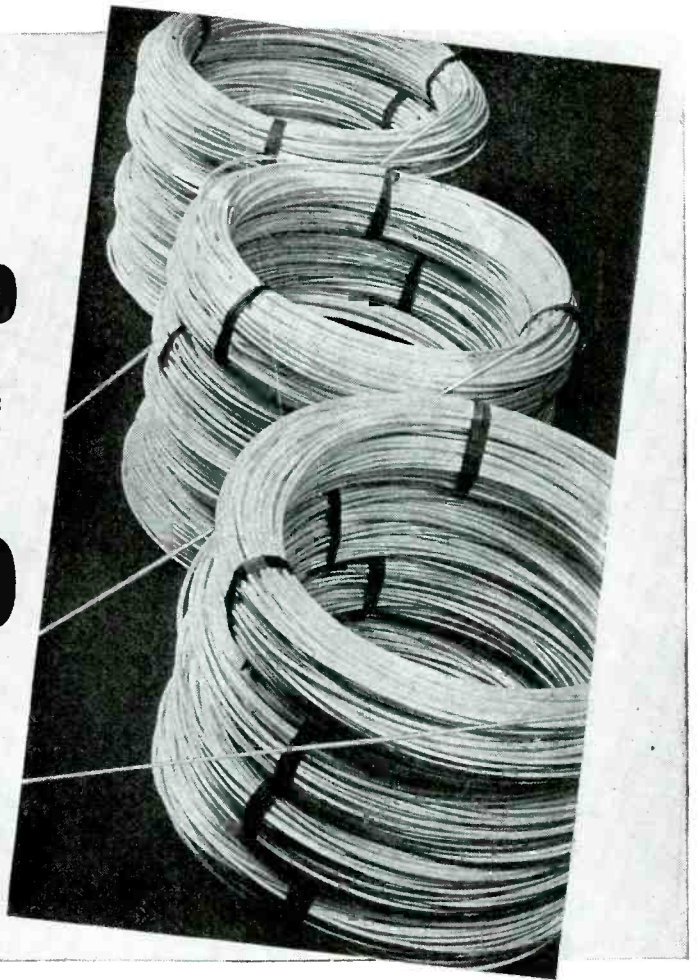

WILCO wire, tubing and other products are used in various electronic applications for the Army and Navy. In response to the wartime demand for these various products, the H. A. Wilson Company has enlarged its plant, increased its manufacturing facilities, added essential new equipment and developed new products and techniques. Both present and future customers will find these new WILCO developments of great advantage.

The H. A. Wilson Company manufactures and is interested in receiving inquiries regarding the following typical products—

#### WILCO JACKETED WIRE

Silver (Fine, Sterling or Coin)  
 Silver Jacketed Copper  
 Silver Jacketed Invar  
 Silver Jacketed Brass  
 Silver Jacketed Steel  
 Gold Jacketed Silver (Fine, Sterling, Coin)  
 Gold Jacketed Brass or Bronze  
 Copper Jacketed Monel  
 Nickel Jacketed Copper

#### WILCO JACKETED TUBING

Silver Tubing (Fine, Sterling or Coin)  
 Gold Tubing (any Color or Karat)  
 Silver Jacketed Brass or Bronze (one or both sides)  
 Gold Jacketed Silver (one or both sides)  
 Gold Jacketed Brass or Bronze (one or both sides)

#### WILCO STRIP MATERIAL

Silver (Fine, Sterling or Coin) on Brass or Bronze (Inlay or Overlay)  
 Gold on Silver (any Karat on Fine, Sterling or Coin)  
 Gold on Brass or Bronze

#### Other WILCO products include Electrical Contacts—

Silver, Platinum, Tungsten, Alloys, Powder Metal. *Thermostatic Bimetal* (High and Low Temperature with new high temperature deflection rates.) *Precious Metal Collector Rings*—For Rotating controls. *Silver Clad Steel*. *Rolled Gold Plate*. *Special Materials*.

*Let us analyze your problems.*

## THE H. A. WILSON COMPANY

105 Chestnut Street, Newark 5, N. J.

Branches: Detroit • Chicago





# WORLD'S FASTEST PLANE *uses* ANDREW COAXIAL CABLES!

*Lockheed's sensational new jet-propelled super fighter, the P-80 "Shooting Star," is the world's fastest and highest flying plane.*

★ It is highly significant that Andrew coaxial cables were chosen for the vital radio and radar equipment installed in the P-80. They were selected because they are much more resistant than ordinary solid dielectric cables to the high temperature encountered in the tail of the plane.

Andrew Co. is a pioneer manufacturer of antenna tuning and phasing equipment, including a complete line of ceramic insulated coaxial cables and all necessary accessories.

*Write for catalog.*



## ANDREW CO.

363 EAST 75th STREET, CHICAGO 19, ILLINOIS

## PERSONNEL

W. S. Winfield has been appointed chief engineer of the home radio division of Westinghouse Electric Corp., Sunbury, Pa. For the past eight years he has been associated with the Colonial Radio Co., Buffalo and in addition served during 1942-'43 as consulting engineer to the Ordnance division of Bell Aircraft specializing in electronic applications.



W. S. Winfield



F. X. Rettenmeyer

Francis X. Rettenmeyer has been appointed chief components engineer of Federal Telephone and Radio Corp., affiliate of International Telephone and Telegraph Corp. His work will involve the engineering of selenium rectifiers, quartz crystals, transformers and coils, special purpose and transmitting tubes, Intelin cables and other components. Previously, Mr. Rettenmeyer had been for ten years chief receiver engineer and staff engineer for the RCA Division of the Radio Corp. of America, at Camden. He also spent ten years with Bell Telephone Laboratories, where he was responsible for the design and development of all radio receivers, navigation equipment, mobile and fixed unattended station radio communication equipment, ship to shore radio receivers and marine direction finders, power line carrier telephone equipment and measuring equipment.

Lawrence C. F. Horle, New York radio consulting engineer, has been appointed chief engineer of the Radio Manufacturers Association, Engineering Department. In this capacity, he will be responsible for the management of the department, including the RMA Data Bureau, and related activities.

Oscar Katz, who has been assistant director of research for Columbia Broadcasting System, has been named associate director. He joined CBS in 1938, put in part of '42 in government service with the Office of Facts and Figures, later with OWI.

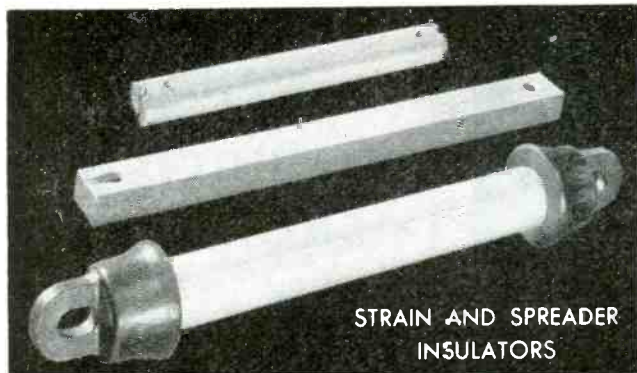

STRAIN AND SPREADER  
INSULATORS

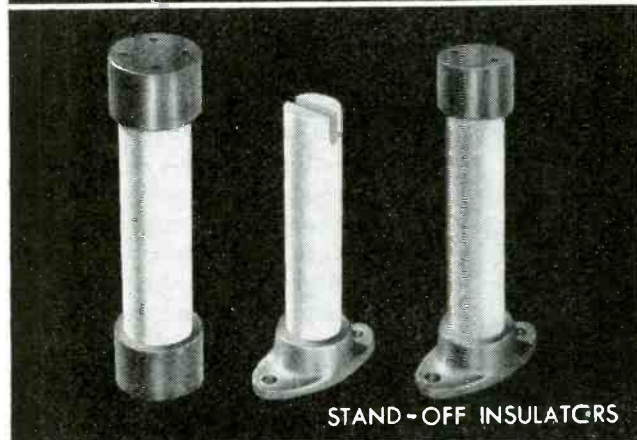

STAND-OFF INSULATORS

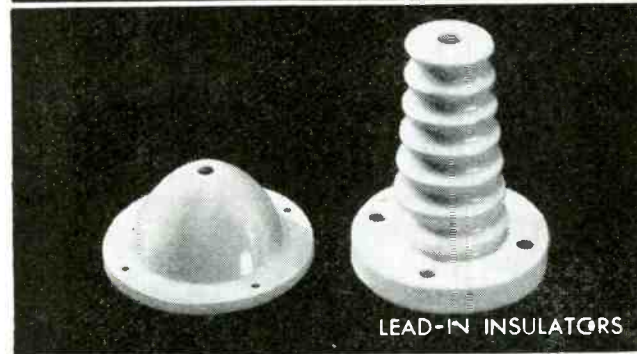

LEAD-IN INSULATORS

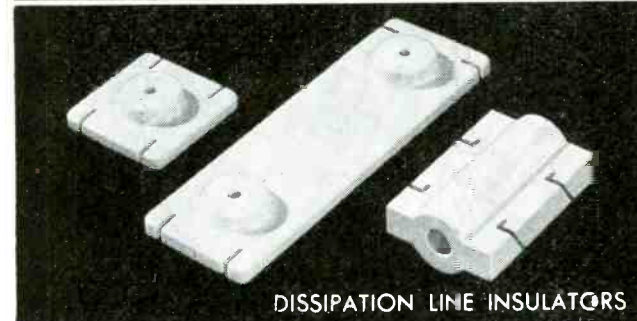

DISSIPATION LINE INSULATORS

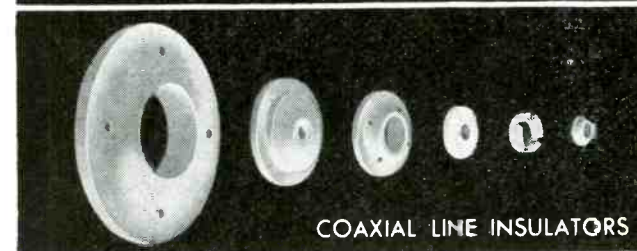

COAXIAL LINE INSULATORS

# STEATITE INSULATORS FOR TRANSMITTING ANTENNA AM - FM - TELEVISION BY **STUPAKOFF**

Stupakoff, pioneer manufacturer of radio grade ceramic insulation, produces a complete line of strain, spreader, stand-off, entrance, coaxial and dissipation line insulators for all types of transmitting stations. Made of Stupakoff Steatite (Grade L-4), their low electrical loss and high mechanical strength make them ideal for high frequency applications.

Metal fittings are available in bronze, brass, stainless steel or malleable iron—plated according to requirements. Insulators are glazed white, chocolate brown or olive-drab for added protection.

Installed on transmitter stations in all parts of the world, Stupakoff precision insulators have proven their dependability in service. An engineering staff backed by two generations of experience will assist you in planning projects in the transmitting field. Technical data on transmission line insulators will be sent on request.

★ ★ BUY WAR BONDS ★ ★



STUPAKOFF CERAMIC AND MANUFACTURING CO., LATROBE, PA.

*Ceramics for the World of Electronics*



# SPARE PARTS BOXES

Made as per specification—42 B 9 (Int) for shipboard use,  
Electrical and Mechanical. Navy grey finish.  
Immediate Delivery.

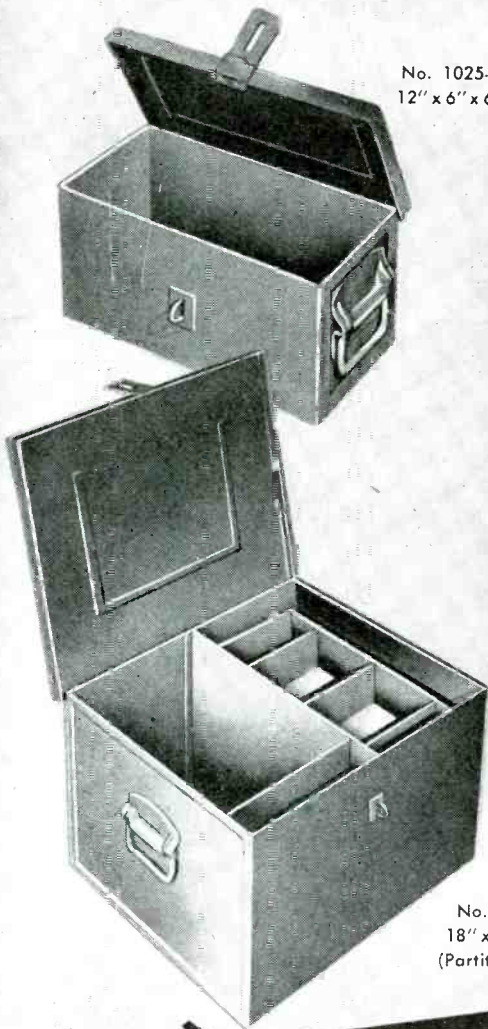

No. 1025-1  
12" x 6" x 6"

24 STOCK SIZES			
Number	Length	Width	Height
1025-1	12	6	6
1025-2	12	9	6
1025-3	12	12	6
1025-4	12	9	9
1025-5	18	9	6
1025-6	18	9	9
1025-7	18	12	9
1025-8	18	6	6
1025-9	18	15	9
1025-10	18	12	6
1025-11	18	15	12
1025-12	18	12	12
1025-13	18	18	12
1025-15	24	15	12
1025-16	24	15	15
1025-17	24	18	12
1025-18	24	18	15
1025-19	24	18	18
1025-20	24	12	9
1025-23	30	15	9
1025-14	30	15	12
1025-22	36	12	9
1025-21	42	9	9
1025-24	42	12	9

WRITE FOR PRICE LIST

No. 1025-11  
18" x 15" x 12"  
(Partitions extra)

**Cole Steel**  
**office equipment**  
will again be available  
after the war

# COLE

STEEL EQUIPMENT COMPANY  
349 Broadway, New York 13, N. Y. Factory: Brooklyn

**WANTED**

## TECHNICIANS ENGINEERS

Radio  
Drafting  
Electrical  
Electronic  
Mechanical  
Manufacturing Planning

Present and post war work in connection with the engineering and manufacturing of a wide variety of current and advanced developments of communication parts, equipment and electronic devices.

Write giving full details and qualifications to:

Employment Department

The F. W. Sickles Co.  
Box 330, Chicopee, Mass.

WMC Regulations

RADEX

CHICAGO

**I**n future peace-time production, Radex will uphold its war-won reputation by the scope and caliber of its service to the radio and electrical industries.

**Radex Corporation**

53 W. Jackson Blvd., Chicago 4, Ill.

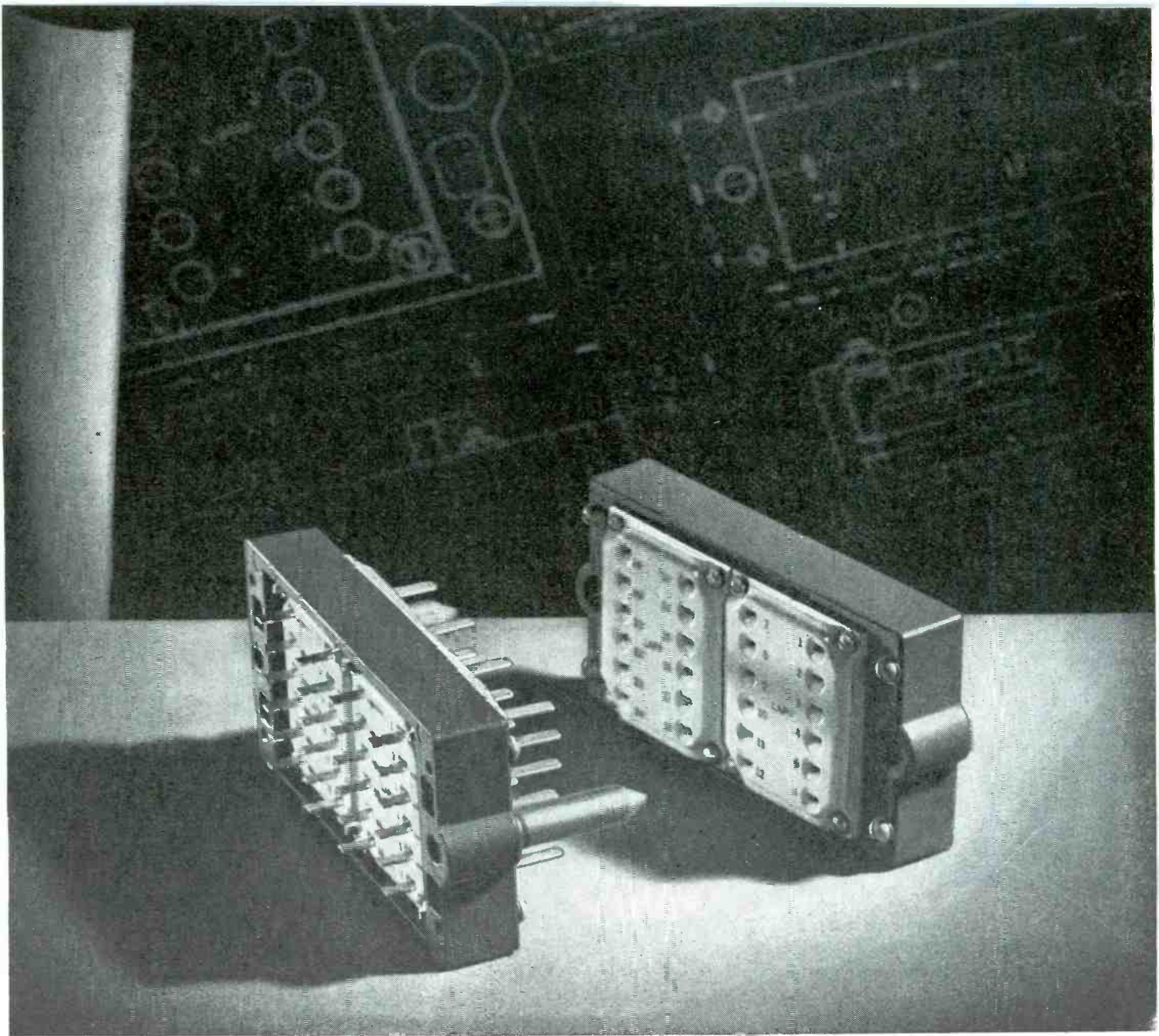

## *An Electronic Part* ... ENGINEERED TO A SPECIFIC NEED

This is a special-purpose electronic part. It is a plug-receptacle assembly for use with rack-panel type of mounting. Twenty-four silver-plated phosphor-bronze contacts are provided, each male and female contact full floating between steatite plates. Heavy guide pins and matching holes in the frame assure perfect alignment.

We don't know that your product has any need for such a part as this. We do know, however, that this part is most exactly suited to its special requirement, just as are hundreds upon hundreds of other parts which have been created through Lapp engineering and Lapp production facilities directed to the solution of specific problems.

With a broad basic knowledge of ceramics—their capabilities and their limitations—Lapp has been able to simplify and to improve many types of elec-

tronic equipment through engineering and production of sub-assemblies that make most efficient use of porcelain or steatite and associated metal parts.

There may be a way you can improve performance, cut costs and cut production time through use of Lapp-designed and Lapp-built sub-assemblies. We'd like to discuss your specific requirements with you. *Lapp Insulator Co., Inc., LeRoy, N. Y.*



# An important statement on CARDWELL deliveries...

Almost all standard Cardwell Capacitors are now being made at our Plainville, Connecticut, plant. The splendid facilities of this newly acquired plant will permit us to produce greater quantities, and to considerably improve delivery schedules.

## Now Ready! CARDWELL CATALOG

NO. 46



... a valuable new edition, just off the press. Filled with descriptions, charts and photographs of standard Cardwell capacitors, accessories and precision instruments.

... a handy reference manual of unusual interest to engineers and purchasing agents working on present and postwar projects. Your copy will be sent immediately.

### MAIL THIS COUPON TODAY

THE ALLEN D. CARDWELL MFG. CORP.  
81 PROSPECT STREET  
BROOKLYN 1, NEW YORK

Please send me a copy of the Cardwell Catalog #46.

NAME .....  
FIRM NAME .....  
ADDRESS .....  
CITY ..... STATE .....

# CARDWELL CONDENSERS

THE ALLEN D. CARDWELL MANUFACTURING CORPORATION  
81 PROSPECT STREET  
BROOKLYN 1, N. Y.

## PERSONNEL

**Dr. Daniel E. Noble** has been promoted general manager of the communications and electronics division of Galvin Mfg. Corp., Chicago. He will remain director of research,

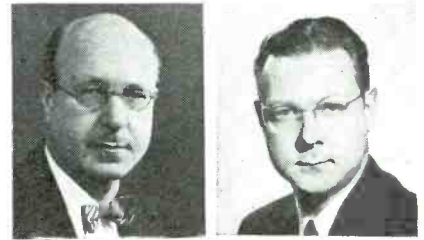

Dr. D. E. Noble

F. B. Smith

**Francis B. Smith** has been appointed chief engineer of The Rola Co., Cleveland, Ohio. A widely known acoustical engineer, he was formerly in charge of audio-frequency and acoustics at Zenith Radio Corp., Chicago, and previously was associated with the Hammond Instrument Co., Chicago.



Lt. Harvey Picker

**Lt. Harvey Picker**, USNR, recently returned to inactive status by the Navy, has been elected president of the Picker X-Ray Corp. Lieut. Picker, who for the past three years has been serving with the

Navy Liaison Officer at the Radiation Laboratory, Massachusetts Institute of Technology, Cambridge, Mass., was executive Vice President of the Company until May 1941, when he went on active duty with the Navy. In 1938 Lieut. Picker joined the firm, of which his father Mr. James Picker, is founder.



Arthur Halloran

**Arthur Halloran**, who has been appointed West Coast Editor for Electronic Industries has long been intimately connected with radio engineering activities, is at present also consultant on UHF at Harvard University radio research labs.



# HARVEY

taking orders for  
the newly improved

## REK-O-KUT

### RKD-16

DUAL SPEED 16-INCH  
RECORDING MOTOR ASSEMBLY



To essential users\*, HARVEY can now supply the famous RKD-16, with new features that materially increase the life and performance of the unit. Its rugged construction and precise assembly have made this REK-O-KUT instrument generally preferred by major broadcasting stations and recording studios. A heavier turntable, closer machining tolerances and an improved lubrication system now add to its efficiency.

Three week delivery.....\$148.38

#### Features of the REK-O-KUT RKD-16

- Lathe turned, 25 lb. cast iron turntable, balanced, with disappearing drive pin and rubber turntable pad.
- Turntable fitted with one inch diameter polished steel shaft, with special oil grooves for force feed lubrication when operating. Rotates on a single ball bearing at the bottom of the turntable well.
- 1/20 H. P. General Electric constant speed motor.
- A positive repeat speed change at all times.
- The turntable attains full speed in less than one revolution.
- Easy alignment of the REK-O-KUT overhead mechanism with the turntable.
- Improved lubrication system.

\*AA-5 Priority or Better!

**NOTE:** Since our monthly allotment is subject to WPB regulations, we suggest that you send your order without delay.

Telephone: LOngacre 3-1800

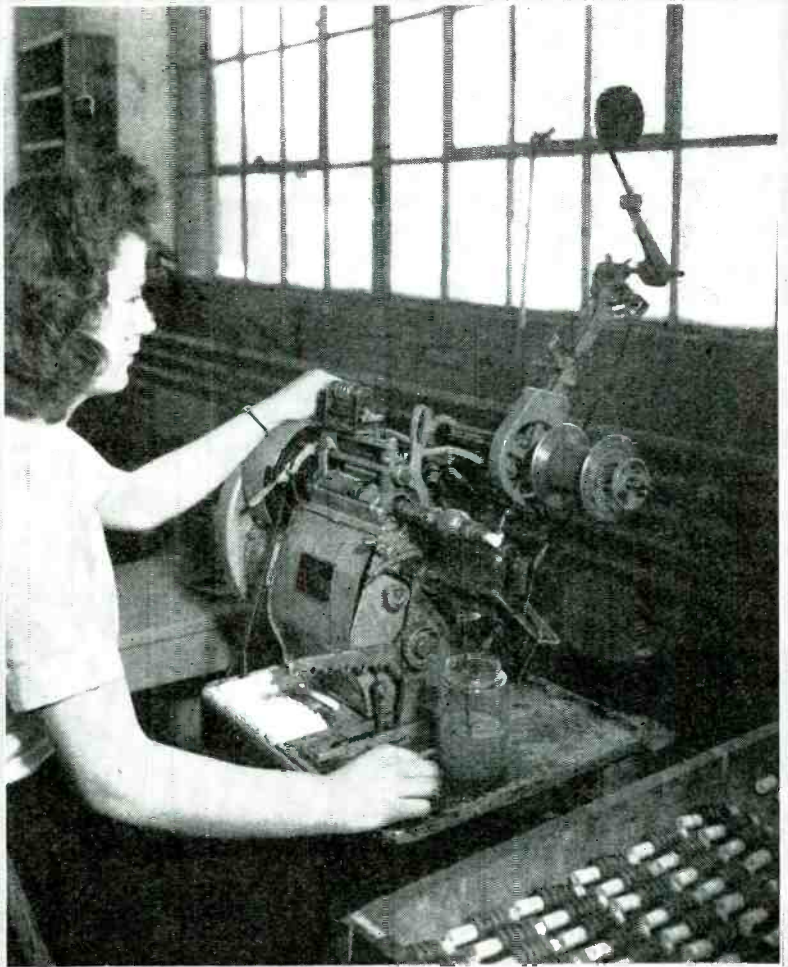

No. 4 of a Series

## MODERN COIL WINDINGS

The "Honeycomb" or Universal Lattice Coil is still a popular winding in radio frequency circuits or as R. F. Chokes.

We can furnish this type of winding on tubes, dowels, resistor forms and iron slugs to close inductance tolerances and conductor sizes from No. 18 to No. 40.

### COTO-COIL CO., INC.

COIL SPECIALISTS SINCE 1917

65 PAVILION AVENUE

PROVIDENCE 5, R. I.

**HARVEY**  
**RADIO COMPANY**  
**HARVEY**  
103 WEST 43rd ST., NEW YORK 18, N. Y.

**MOTOR DATA**  
No. 130

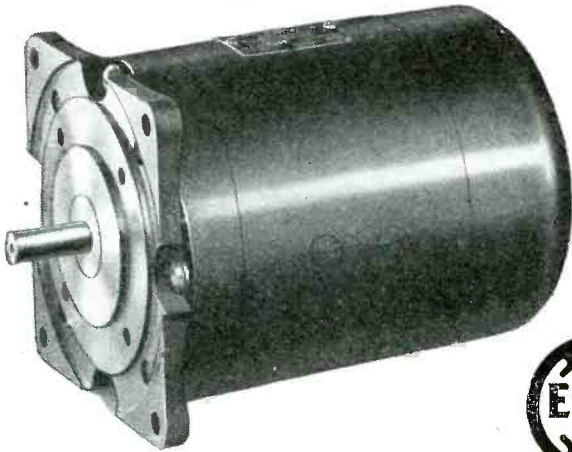

**5200 FRAME MOTOR**  
1/4 HP at 1625 RPM

This motor was the answer to a customer's question . . . "Will you design a totally enclosed dual motor unit to drive our warehouse trucks?" Today Type 5230 motors, thousands of them, are wheeling industrial loads. Such engineering service, instantly available, may also solve a difficult motor problem for you.

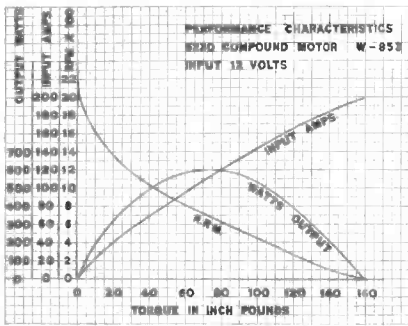

**FEATURES**

**ELECTRICAL**  
Series, shunt, or compound-wound  
Unidirectional or reversible  
Optional torque  
Optional speed  
Optimum efficiency  
For control circuits  
Electric braking optional

**MECHANICAL**  
Ventilated or enclosed types  
Base or flange mounting  
Operation in any position  
Low space factor  
Ball bearing equipped  
Optional shaft details  
Rugged construction

5200 FRAME MOTORS	5220 Shunt	5230 Compound
Output, Con. (H.P.)	1/4	1/4
Torque at 3900 RPM (in. lbs.)	4.5	10
Torque at 1625 RPM (in. lbs.)	45	160
Lock Torque (in. lbs.)	6	6
Volts input (min.)	110	110
Volts input (max.)	5 1/4"	5 1/4"
Diameter	8"	9"
Length less shaft (max.)	1/2"	1/2"
Weight (lbs.)	18	24

**EICOR, INC.** 1501 W. Congress St., Chicago, U. S. A.  
DYNAMOTORS • D. C. MOTORS • POWER PLANTS • CONVERTERS  
Export: Ad Auriema, 89 Broad St., New York, U. S. A. Cable: Auriema, New York



Pan American World Airways

**As Essential In Peace As In War!**

Premax Tubular Antennas have done a grand job on the Flat Tops, Battle Wagons, LST and PT Boats . . . just as they are doing an outstanding job in peacetime communications.

**Premax Products**

Division Chisholm-Ryder, Co., Inc.  
4503 Highland Ave., Niagara Falls, N. Y.

**JONES SHIELDED TYPE PLUGS and SOCKETS**

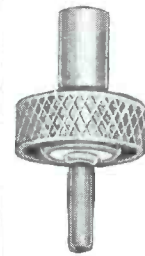

P-101-1/4"

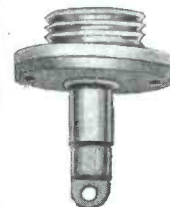

S-101

Low loss Plugs and Sockets suitable for high frequency circuits. Ideal for antenna connections, photo-cell work, microphone connections, etc. Supplied in 1 and 2 contact types. The single contact type can be furnished with 1/4", .290", 5/16", 3/8", or 1/2" ferrule for cable entrance. Knurled nut securely fastens units together.

All metal parts are of brass suitably plated to meet Navy specifications. No. 101 Series Plugs have ceramic insulation and Sockets have XXX Bakelite. For complete listing and information write today for your copy of catalog No. 14.

**HOWARD B. JONES COMPANY**  
2460 W. GEORGE ST. CHICAGO 18

# OHMITE

## Rheostats and Resistors

IN PRODUCTION OF

# Penicillin

USED IN  
**ELECTRONIC POWER GENERATOR**  
 that dries Penicillin 48 times faster

• A new RCA electronic system, using high frequency current for the bulk reduction of purified Penicillin, accomplishes in 30 minutes what formerly took 24 hours.

In the RCA Electronic Power Generator are six Ohmite resistors and two Ohmite rheostats. Circled in the photo above are a 200 watt regulator plate resistor, two 200 watt cathode bias resistors for the two power tubes, and a 50 watt rheostat used as a cathode balancer. Not visible in the photo are two 10 watt Brown Devil resistors used for voltage dropping in the pilot light circuits, one 10 watt Brown Devil in a time delay relay circuit, and a 50 watt rheostat used as the output power control.

The use of Ohmite products in such vital electronic equipment is further proof of their complete reliability.

### OHMITE MANUFACTURING COMPANY

4983 FLOURNOY STREET, CHICAGO 44, U. S. A.



Write on company letterhead for Industrial Catalog and Engineering Manual No. 40. Address Ohmite Mfg. Co., 4983 Flournoy St., Chicago 44

Be Right with **OHMITE**  
 RHEOSTATS • RESISTORS • TAP SWITCHES

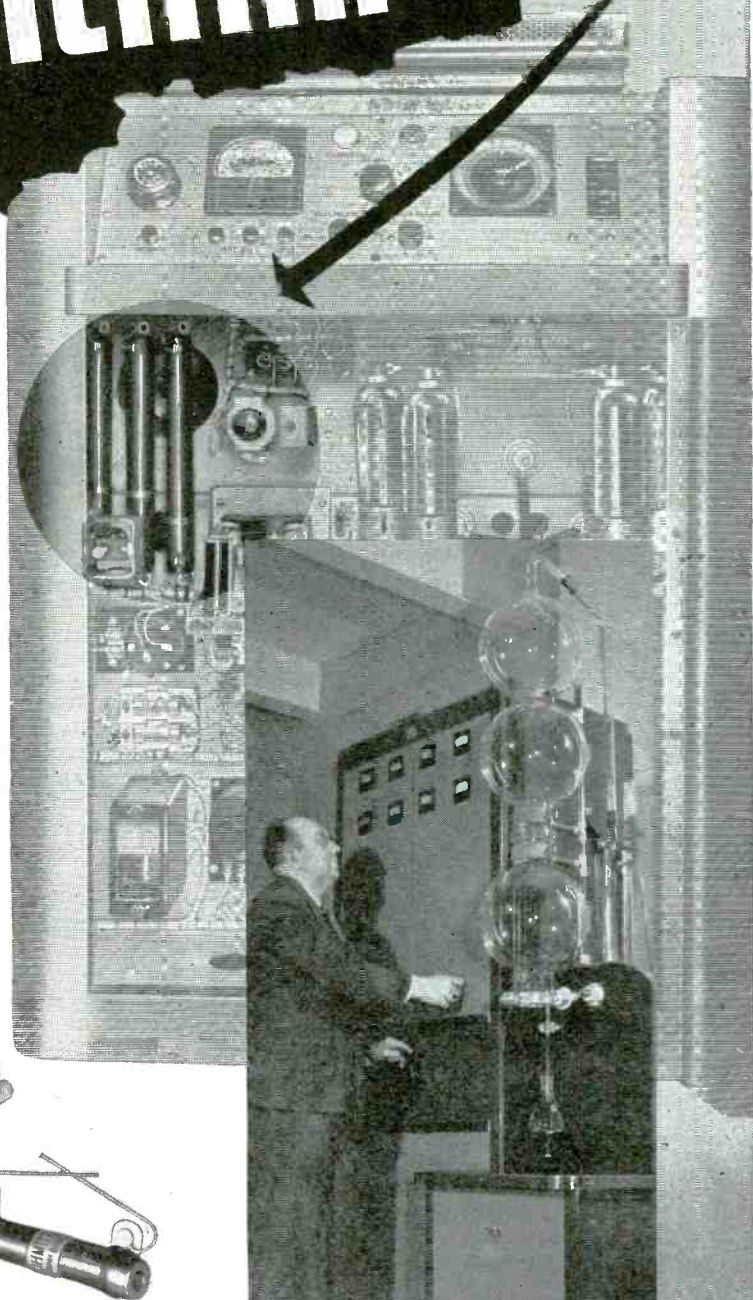

## NEW BOOKS

### **International Control of Radiocommunications**

By John D. Tomlinson, published by J. W. Edwards, Ann Arbor, Michigan, 1945, 314 pages, \$2.50. (Originally presented as a dissertation at the University of Geneva, Switzerland.)

The text is not and does not intend to be of a technical nature, but tells the story of the international legislation regarding communication with emphasis on problems related to social science. Special attention is given to international technical agreements necessitated by the propagation of radio waves which respect no frontiers.

The first chapters contain a chronological compilation of regulations adopted at various conferences. Later chapters deal with special topics, such as the traffic and operation of services, the international interference restrictions, and frequency allocations; the last chapters are headed: the regulation of broadcasting, regional and bilateral agreements, the legislative, administrative and judicial machinery, the influence of private companies and international organizations, and conclusions. The last chapter summarizes the inferences made in the previous chapters regarding the need for international conventions, trends in the history of radio legislation to reconcile conflicting interests and development of legislative processes to this end.

### **Treatise on the Theory of Bessel Functions**

By G. N. Watson, Sc.D., F.R.S., Professor of Pure Mathematics in the University of Birmingham, lately Fellow of Trinity College, Cambridge; published by Cambridge, at the University Press, New York, the Macmillan Company; 804 pages; \$15.00.

The second edition of this text, generally accepted by authorities as a standard work on the mathematical aspects of Bessel functions, comprises a rigorous and comprehensive treatise of this mathematical branch. Intended for students seeking to gain an intimate knowledge of Bessel functions, and as a tool of prime value for the research worker, the text assumes considerable previous mathematical studies.

As stated in the preface, the book has been designed with two objects in view: The first is the development of applications of the fundamental processes of the theory of functions of complex variables; the second object is the compilation of a collection of results which would be of value to the increasing

number of Mathematicians and Physicists who encounter Bessel functions in the course of their researches. For instance, familiarity with some results of the theory of Bessel functions is compulsory to understanding of frequency modulation theory and cylindrical cavity resonator characteristics.

### **Electronics Laboratory Manual**

By Ralph R. Wright, published in 1945 by McGraw-Hill Book Company, New York, 77 pages with sketches, price \$1.00.

This manual was prepared to serve as a laboratory text book for engineering students, and as a guide to the technic of vacuum tube circuits and associated components. The book contains detailed experiments involving the characteristics of vacuum tubes, amplifiers and certain commonplace devices, such as an oscillograph and a power supply system. The experiments are explained in careful detail and should give students useful experience in using and handling the more common circuit items.

### **UHF Radio Simplified**

By M. S. Kiver, Published by D. Van Nostrand Company, Inc., New York. Price \$3.25, 238 pages.

This new book on ultra-high frequency theory is a simplified, non-mathematical treatment of the characteristics of electromagnetic waves at the ultra-high frequency regions. The first chapter, entitled "Introduction to the Higher Frequencies," concerns itself with the transition from ordinary radio circuits to the higher frequencies and the effects produced by the physical size of the various electrical components ordinarily used in common radio circuits. For example, the transit time of the electron tube is described briefly as it affects the performance of ordinary tubes at high frequencies.

The second chapter deals with the magnetron oscillator, the third chapter covers the velocity modulated tube or Klystron type of ultra-high frequency generator. Additional chapters cover transmission lines, wave guides, cavity resonators, UHF antennas, UHF measurements, and wave propagation. A number of questions dealing with the material in each chapter are given at the back of this volume.

### **The Electrolytic Capacitor**

By A. M. Georgiev. Published by Murray Hill Books, Inc., New York. Price \$3.00, 191 pages.

This book on the theory of electrolytic capacitors, the manufacturing processes, the technical fea-

(Continued on page 212)

## RADAR GLOSSARY

(Continued from page 198)

vertical coordinate.

**Expanded scope**—A magnified portion of a given type of CRT presentation; for example, P<sup>3</sup>I.

**F**—U. S. Navy prefix to designate shipborne fire control radar. Examples: FC, FD, FH, etc. Designation later changed to Mark III, Mark IV, Mark VIII, etc.

**Frey**—German early-warning radar set.

**F-scan**—A single signal only, appearing as a bright spot. Azimuth error angle (relative bearing) appears as the horizontal coordinate, elevation angle as the vertical coordinate.

**Gate**—A square voltage wave which switches a circuit on or off electronically, usually by application to a grid or cathode.

**GCA**—Ground control of the approach of an aircraft to an airfield.

**GCI**—Ground control of interception. The technic that is accomplished by coordination between a land-based radar set and fighter aircraft equipped with their own radar sets.

**GCL**—Ground control of the landing of aircraft.

**GL**—Gun laying. Information supplied by GL equipment (range, bearing and elevation) is used to direct guns and to control their firing.

**Grid pulsing**—A circuit arrangement of the RF oscillator in which the grid of the oscillator is biased so negatively that no oscillations take place even when plate voltage is applied to the tube, and pulsing is accomplished by removing this negative bias through the application of a positive pulse on the grid.

**Ground return**—Radiation which is reflected from the ground and is returned as an echo to the radar set.

**G-Scan**—A single signal only, appearing as a bright spot on which wings grow as the distance to the target is diminished. Azimuth angle appears as the horizontal coordinate, elevation angle as the vertical coordinate. This has been referred to as Mark VI indication.

**Guillemin line**—The network used in high level pulse modulation in generating a nearly square pulse with steep rise and fall.

**Helical scanning**—The scanning motion in which a point on the RF beam describes a distorted helix. The antenna rotates continuously about the vertical axis while the elevation angle changes slowly from the horizontal to the vertical.

**H-Scan**—A modification of B-Scan. Signal appears as a bright line

(Continued on page 214)

# LET'S LOOK UNDER THEIR BUSHELS!



Many and valuable—even spectacular—are the wartime achievements of the electronic industry. On land, at sea and in the air, men and fighting equipment have moved into action with amazing synchronization—victories have been won—many lives and days have been saved—through the direction, guidance and safety of electronic creations. The contributions of electronic devices to all-time war production records here at home are equally amazing. In fact, the needs of war have given such immense impetus to the value of electronics in the communications and industrial fields that it has become one of our Nation's great industries whose peacetime future is full of rich promise.

This war-stimulated progress reflects great credit, indeed, on the genius and resourcefulness of the entire electronic industry—and especially on the tube manufacturers of America. For largely because of their pioneering accomplishments in developing and supplying new kinds of tubes for the many new-found war uses, along with improving existing types, has it been possible to put electronics to work in so many places. Making tubes is *not* our business. Yet we at Speer are keenly aware of the almost incredible wartime record achieved by those who do while taking little or no credit for themselves. For their vital—though still largely censored and unheralded role in gaining Victory, it seems uniquely fitting to say "Well done" to all tube manufacturers, many of whom it has been our privilege to serve.



## SPEER

CARBON COMPANY  
ST. MARY'S, PA.

CHICAGO • CLEVELAND • DETROIT  
MILWAUKEE • NEW YORK • PITTSBURGH

### PRODUCERS OF TRANSMITTING, RECTIFYING, AND POWER TUBES, 1944-1945

Amperex Electronic Products  
de Forest Laboratories, Lee  
Eitel-McCullough, Inc.  
Electronic Enterprises, Inc.  
Federal Telephone and Radio Corp.  
General Electric Co.  
General Electronics Company  
General Electronic Industries  
Heintz & Kaufman, Ltd.  
Hytron Corp.  
Ken-Rad Tube & Lamp Corp.  
Machlett Laboratories  
National Union Radio Corp.  
North American Philips Co.  
Raytheon Mfg. Co.  
Radio Corp. of America  
Sal-Mar Laboratories  
Slater Electric & Mfg. Co., Inc.  
Sperry Gyroscope Co., Inc.  
Sylvania Electric Products, Inc.  
Taylor Tubes, Inc.  
Translite, Inc.  
Tung-Sol Lamp Works, Inc.  
United Electronics Co.  
Western Electric Co., Inc.  
Westinghouse Lamp Div.,  
Westinghouse Electric & Mfg. Co.

## NEW BOOKS

(Continued from page 210)

tures and a bibliography, is planned to be of value to engineers concerned with the design and manufacture of these units, as well as the group of engineers and maintenance men concerned with the equipment in which capacitors of this type are used.

Chapters in this book include descriptions of the electrodes and electrode materials, dielectric film from practical and theoretical considerations, filming electrolyte, the filming process, the etching of electrodes, the winding of capacitor sections, the container and vent, special tests for electrolytic capacitors, some of the uses of electrolytic capacitors. A glossary of electrolytic capacitor terms, a bibliography of technical articles on this type of capacitor, and important U. S. patents by numbers and inventors are also included in this book for reference value.

The book is illustrated with drawings and photographs as well as graphical data on electrolytic capacitors.

### **Electrical Drafting Applied to Circuits and Wiring**

By D. W. Van Gieson, published by McGraw-Hill Book Company, Inc., New York, 1945, 140 pages, illustrated, price \$1.50.

This book outlines a few of the basic procedures used in the preparation of sketches of electrical wiring. Although considerable space is allotted to the description of the theories of operation of many of the components that appear in electrical circuits, this book, however, does not adequately cover the subjects that a circuit draftsman in the electronics and radio fields, is bound to need.

It would seem to this reviewer that it would have been far better to have eliminated all matters which are descriptive of instruments and their operation. After all, the theory of a vacuum tube, automobile starting motor, telephone, etc., cannot be handled satisfactorily in the short space allotted, whereas information concerning the difficult problems of laying out a diagram so that the simplest diagram, without congestion of connecting wires results. The book contains useful tables of ASA standard symbols, abbreviations, wire sizes and certain mathematical tables.

### **Plastics in Practice**

By John Sasso and Michael A. Brown, Jr., published 1945 by the McGraw-Hill Book Co., New York 18, N.Y., 185 pages—size 7½ x 10 in. with illustrations. Price \$4.00.

A review of successful commercial applications of plastic mate-

rials, taking up reasons for their selection and the technical solutions to the problems encountered when those materials replaced others. The book contains considerable information on plastics materials, properties, methods of fabricating, and design and cost factors, related directly to their specific uses. A large list of sources of information is included from catalogs and bulletins.

### **Introduction to the Theory of Filters in Communication Engineering**

Einführung in die Siebschaltungstheorie der elektrischen Nachrichtentechnik by Dr. R. Feldtkeller, Institute of Communications Engineering, University of Stuttgart, published by J. W. Edwards, Ann Arbor, Michigan, 174 pages, \$5.00.

The text, an elementary treatment of symmetrical, low-frequency, low-pass, high-pass and band-pass filters, is a lithoprint of the German edition. Because of its basic character, the book cannot be expected to offer any information not readily available in textbooks published in this country in a language, terminology, and symbols more familiar to the American engineer. Unless future study of German literature on the subject is intended, this reviewer is not aware of any advantage of the present text over a similar book originally published in this country.

### **Standards Monographs**

Adding to its re-printed Standards publications, Institute of Radio Engineers has produced monographs on "Radio Wave Propagation" and "Piezoelectric Crystals." The former contains a compilation of terms relating to guided waves; the latter contains recommended terminology and is directed especially to the attention of authors in this field.

### **40-Kw Tele Transmitters**

General Electric, postwar, will build a 40-kw television transmitter—one of the world's largest—for the Don Lee Television and Don Lee Broadcasting Systems. The west coast network has filed with the Federal Communications Commission for permission to install the transmitter 5,800 feet above sea level on Mt. Wilson outside Hollywood, Calif. Station W6XAO, the network's television station in operation in Los Angeles since Dec. 23, 1941, will be used as a television relay station and studio site after the new transmitter is installed. General Electric also will build 40-kw television transmitters for the Chicago Tribune and New York Daily News postwar.

## NEW BULLETINS

### **Industrial Tube Manual**

A comprehensive loose leaf manual on industrial tubes has been issued by the General Electric Co., Schenectady, N. Y., for use of application engineers and others. About 93 different tubes are described. In addition a wealth of technical information and suggested circuits are incorporated so that an intelligent selection can be made.

Tubes presented are divided into the following broad types. Ignitrons, or mercury vapor discharge pool type cathode tubes used for welding, rectifying and inverting; Thyratrons, or grid controlled gas rectifiers and control tubes used in numerous applications, kenotrons or 2 element high vacuum rectifiers which can be used in circuits up to 150,000 volts per tube; phantotrons or plain gas rectifiers usable up to 22,000 volts per tube; and pliotrons or high vacuum triodes used in all kinds of transmitting and oscillator circuits.

Also featured are voltage regulator or glow tubes, a number of phototube styles with varying sensitivity and spectral response, constant current or ballast tubes, vacuum gages and switches. Unusual types are included such as the FP-54 electrometer tube which has been found capable of measuring currents as small as  $5 \times 10^{-18}$  amperes, about 30 electrons per second; the GL-931A phototube which by the use of secondary emission has a sensitivity of 2 amperes per lumen; and ionization and resistance gages for measuring low gas pressures electrically.

Power oscillators available go up to 100 kw in size (GL-862A pliotron).

### **Resistance Measurements**

Anyone concerned with a problem in dc resistance measurements should find of value a new 36-page edition of Leeds & Northrup Co.'s catalog, E-53 "Apparatus for dc Resistance Measurements."

This publication not only presents resistance bridges, but the standards, galvanometers, accessories, etc., usually chosen for use with them. Instruments for a wide variety of applications will be found here, including models for the most precise measurements, as well as those designed especially for routine testing, student instruction and many others.

Each instrument is listed and completely described.

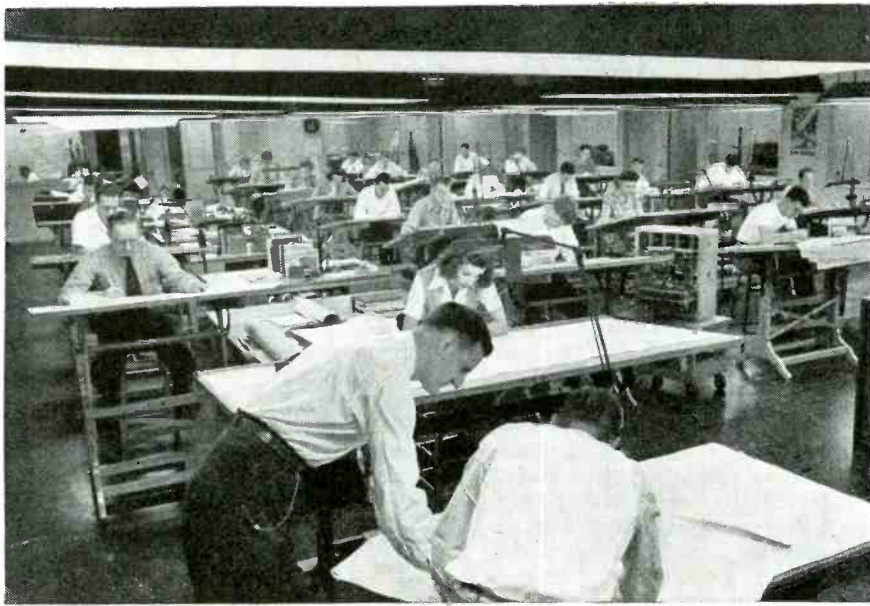

## Experienced Mechanical Drafting Design Engineers, Design Draftsmen, Junior and Senior Draftsmen

The Collins Radio Company has always been a pioneering organization—an *engineer's* engineering and manufacturing outfit.

It was the pioneering urge that led us to introduce professional standards of design and performance in transmitters and receivers for radio hams in the early thirties . . .

To plan and build special radio equipment that stood up to the rough-and-tumble of Admiral Richard E. Byrd's second expedition to Little America . . .

To take high quality broadcast equipment out of the laboratory and make it economically practicable for any broadcasting station . . .

To meet the individual requirements of some of the great airlines with specially engineered communication equipment, including the ingenious Collins Autotune.

To be prepared on December 7, 1941, to go into production of airborne and ground based radio gear of highly advanced design for the Armed Forces—the result of research and development looking years ahead.

We are looking far ahead today in the field of high quality radio communication equipment. Our post-war plans, well advanced, offer a very substantial opportunity for additional

junior and senior draftsmen with at least three to five years of practical mechanical drafting, design draftsmen with at least five years of experience in design drafting, and mechanical drafting design engineers with eight to ten years of mechanical design experience. Our work involves the production of small, intricate mechanical and electrical mechanisms.

This is a splendid opening for men and women who are able to make neat, accurate parts drawings with complete specifications, assembly drawings and layouts, who will assume responsibility, and who have knowledge of general standard shop and field practices. Cedar Rapids is a human, wholesome city of about 65,000. People enjoy living here. And people enjoy working, without being distracted by weather variations, in the modern controlled-conditions Collins plant.

If you feel that you could fit happily and capably into this organization, write us fully. Tell us about your education, experience, age, desired compensation and draft status. W.M.C. regulations, of course, must apply.

Address E. H. Reinschmidt,  
Superintendent of Design,  
Collins Radio Company,  
Cedar Rapids, Iowa.

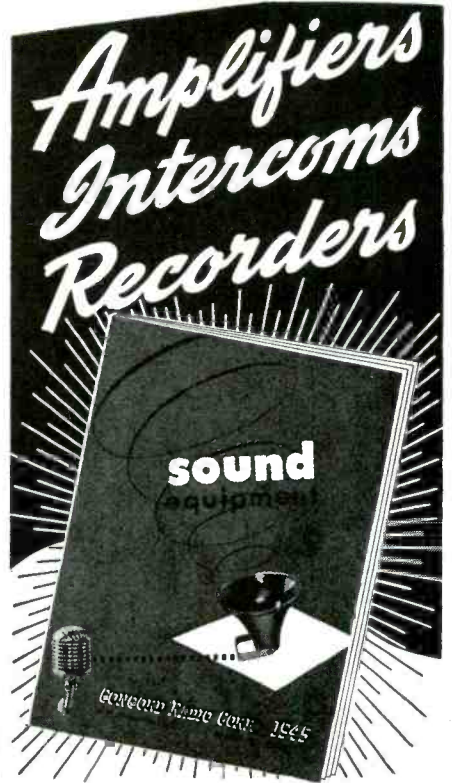

## Write for Important New CONCORD Presentation

"Sound Equipment"—ready now—a new up-to-the-minute Concord folder illustrating and describing our complete line of Amplifiers, Intercoms and Recorders AVAILABLE FOR IMMEDIATE SHIPMENT.

**Amplifiers**—ranging in output ratings of 17 watts to the largest requirements. Complete listing of speakers, microphones and essential equipment also included.

**Intercommunication Systems**—with master and sub-stations for every purpose and need.

**Recording Equipment**—professional type for microphone recording, radio recording, transcriptions, public address.

**Engineering Service**—Our engineering services are at your command, without charge, to answer any and all "Sound Equipment" questions.

Mail the coupon below for your copy of "Sound Equipment" now.



**CONCORD RADIO CORPORATION**  
*Lafayette Radio Corporation*  
CHICAGO 7, ILL. ATLANTA 3, GA.  
901 W. Jackson Blvd. 265 Peachtree Street

CONCORD RADIO CORP.  
901 W. Jackson Blvd., Dept. J-95  
Chicago 7, Illinois

Please send me at once copy of your new "Sound Equipment" folder.

Name.....

Address.....

City.....State.....



## NEW BULLETINS

### CR Photography Screens

In a bulletin "New Designations of Screens for Cathode-Ray Photography," Allen B. Du Mont Laboratories, Inc., Passaic, N. J., provides more precise definitions as well as characteristics covering such screens.

Heretofore two general types of blue screen materials have been used commercially for photographic work. Both have been designated as P5. It has now become apparent, however, that these materials, each offering distinct advantage in certain photographic applications, are sufficiently different to warrant different type designations. These two types of screen materials are sulphide and calcium tungstate. It has been agreed by RMA and the Armed Services to designate the screens having the characteristics of calcium tungstate as P5, and those of sulphide as P11. Du Mont tubes in the past have used the sulphide type screen. Therefore, the change to the P11 designation will not represent a change in screen material to those who have been getting P5 photographic screens from Du Mont.

The general characteristics of P5 and P11 screens compare as follows: Both are of the short persistence, blue fluorescent type, and of high photographic activity. The main difference is the considerably higher photographic and visual efficiency of the P11, and the shorter persistence of the P5. P11 is advantageous for all still photographic applications, particularly high-speed phenomena, and for continuous moving picture recording up to the limit where persistence produces blurring of the picture (approximately 10,000 cps). The use of the P5 screen is recommended only for high-speed continuous motion picture recording above the limit of the P11, or up to 60 kc without blurring.

### Electronic Controls

Wheelco Instruments Co., Harrison & Peoria Sts., Chicago, has issued a new 12-page catalog (Z-6300) on electronic controls. The bulletin describes the electronic principle by which control is effected without contact between measuring and control units of an instrument, and gives brief descriptions and prices of indicating pyrometers and pyrometer controllers, indicating resistance thermometers and resistance thermometer controllers, input controllers, program controllers, portable potentiometers, combustion safeguards, and thermocouples.

## RADAR GLOSSARY

(Continued from page 210)

the slope of which is proportional to the sine of the angle, of elevation. Azimuth appears as the horizontal coordinate, and range as the vertical coordinate.

**IFF**—Identification of friend or foe. System used in conjunction with radar for distinguishing between friendly and enemy aircraft or surface vessels.

**Indicator gate**—A rectangular voltage to the grid or cathode circuit of an indicator cathode ray tube to sensitize it during the desired portion of the operating cycle.

**Interrogator responder**—A unit in the identification system which consists of a transmitter interrogator and receiver response operating on IFF frequencies and synchronized with some type of radar equipment. The receiver is designed to receive the signal from the IFF equipment on the ship or plane interrogated and apply that signal to the radar indicator.

**I-Scan**—Used to depict range and direction for a system with a conically scanning antenna. Signal appears as a bright circular segment with radius proportional to range. The circular length of the segment is inversely proportional to the error of aiming this system and its position indicates the bearing of the target. True aim results in a complete circle. Also referred to as RTB indication.

**Isolation diode**—A diode used to pass signals in one direction through a circuit but which prevents signals and voltages from being transmitted in the opposite direction.

**J-Scan**—A modification of type A in which the time sweep produces a circular range scale near the circumference of the CRT face. The signal appears as a radial deflection of the time trace. No bearing indication is given.

**Keep-alive**—An auxiliary electrode in the TR switch, to which a negative dc potential is applied. The keep-alive is turned on before the main rf power, and furnishes sufficient ions for almost instantaneous discharge across the main gap with small leakage power to the crystal.

**K-Scan**—A modification of type A-scan for aiming a double lobe system in azimuth (elevation). A horizontal (vertical) time sweep is displaced slightly in the direction of the antenna lobe in use. The signal appears as a double vertical (horizontal) deflection of the time sweep with the ratio of amplitudes indicative of the error in aiming.

**Lobe switching**—Directing an rf

beam rapidly back and forth between two positions. Used for accurate direction finding.

**L-Scan**—A modification of type A-scan for aiming a double lobe system in azimuth (elevation). A vertical (horizontal) time switch indicates range. The signal from the left (lower) lobe appears as a horizontal (vertical) deflection to the left (downward); the signal from the right (upward). The ratio of signal amplitudes is indicative of the error in homing. British Mark IV.

**Matching diaphragm**—A window consisting of an aperture (slit) in a thin piece of metal, placed transversely across the wave guide; used as a matching device. The orientation of the slit (whether parallel to the long or short dimension of the wave guide) determines whether it is respectively capacitive or inductive.

**McNally tube**—A local oscillator tube. A single cavity, velocity modulated tube, the frequency of which may be controlled over wide ranges by electrical methods.

**M-Scan**—A modification of type A-Scan for accurate range finding. A horizontal time sweep is displaced stepwise slightly vertically. The signal appears as a vertical deflection of the time sweep. An auxiliary device for controlling the phase of the signal or the step is used to bring them into coincidence, at which point the device registers range.

**N-Scan**—A combination of type K and M-Scan.

**Overshoot**—An excessive potential attained by a portion of the main body of a pulse. Compare Back Swing.

**Own ship's course bus (O.S.C.)**—The cable which feeds the output of a selsyn generator controlled by the ship's gyro compass to the radar set for producing indication of true bearing.

**Pantograph (radar)**—System for transmitting and automatically recording data from CRT to a remote point.

**Pencil mixer**—A form of crystal mixer.

**P<sup>3</sup>I**—Expanded PPI presentation.

**Pip**—A term used to designate a signal or special marker on the A-scope type of presentation.

**Plate pulsing**—A circuit arrangement of the rf oscillator in which the plate voltage is normally reduced to such a low value or completely removed, so that no current flows to the plate and no oscillations occur. A pulse equal to the full plate voltage is then introduced in series with the plate. Oscillations begin and last for the duration of the pulse.

(Continued on page 222)



# CML 1420

## ELECTRONIC GENERATOR

Frequency stability of the CML 1420 is better than 2% after initial warm-up. Maximum distortion at full output into resistive load is 10%. Regulation no-load to full load within 4%. Nominal regulated voltage output 80-120-135-215-255 or 270 volts. Power: input 115 volts 60 cycles 1200 watts single phase.

# TEST POWER for Continuous Duty

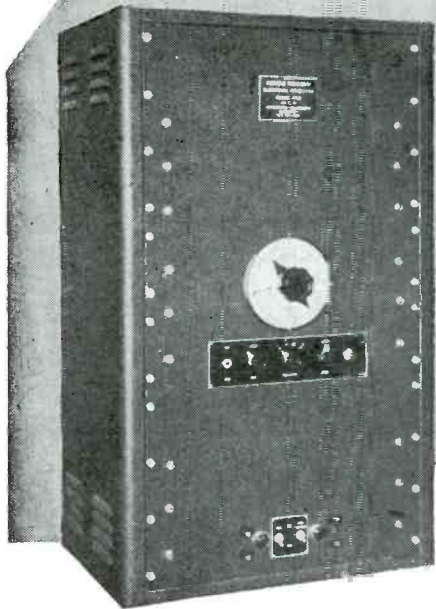

### FREQUENCY RANGE:

50 to 6,000 Cycles in 4 bands

### POWER OUTPUT:

250 Watts Continuous Duty

### FREQUENCY CONTROL

Single dial, direct reading, linear scale in 4 ranges—50-180; 170-600; 500-1800; 1700-6000 cycles.

Send For Descriptive Bulletin

# COMMUNICATION MEASUREMENTS LABORATORY

120 Greenwich St., New York 6, N. Y.  
Rotobridge • Electronic Generators • Power Supply Units



# Vertical



## AREA OF DISTRIBUTION

The new amazing Altec Lansing multi-cellular Duplex Speaker provides up to 800% increased area of quality sound distribution. In the vertical plane, the Duplex delivers a forty degree angle of distribution, or eight times the area distribution at high frequencies as compared to single unit speakers of comparable size. Another reason why the DUPLEX is the SPEAKER that REVOLUTIONIZES the methods of sound REPRODUCTION.

SEND FOR BULLETINS

# ALTEC

LANSING CORPORATION

1210 TAFT BLDG., HOLLYWOOD 28, CALIF.  
250 WEST 57 STREET, NEW YORK 19, N. Y.  
IN CANADA: NORTHERN ELECTRIC CO.

## NEW BULLETINS

### Product Engineering

The Allis-Chalmers Mfg. Co., Milwaukee, Wis., has published a directory of products and engineering literature describing the lines of equipment it furnishes to nearly every industry. Major portion of the directory is devoted to a listing of more than 1,600 product types. Engineering literature is arranged according to product discussed with new bulletins starred. In most cases the literature contains operating data, charts, formulas, and technical information of value to the man who specifies and buys equipment.

### Rust Prevention

A new booklet issued by the Federal Telephone & Radio Corp., Newark, N. J., describes methods of preventing corrosion of outdoor structures by passing a direct current from soil to structure in opposition to the electrolysis currents. Application of selenium rectifiers to this service is discussed and illustrated. The title of this publication is Cathodic Protection and Application of Selenium Rectifiers.

### BC Documentation

"Management in the Public Interest," a 120-page book containing 400 photographs illustrating 26 avenues of public relations for broadcasters, is being distributed by National Association of Broadcasters. This is the industry's first comprehensive study of its public relations opportunities. However, it is illustrated so forcefully by photographs of actual practices and achievements that it becomes a strong documentation of radio's operation in the public interest.

### Vibrating Reed Meters

Uses for vibrating reed frequency meters are described in new bulletin VF-43-1C published by J-B-T Instruments, Inc., New Haven 8, Conn. Included are several special purpose meters designed to take advantage of the extreme accuracy of this basic type of instrument. These are resonant tachometers, water temperature meters, harmonic checkers, etc. Accuracies to 0.1 per cent are feasible.

### Molded Products

A six page illustrated folder of molded products has been issued by Mack Molding Co., Inc., 180 Main St., Wayne, N. J. Photographs of many custom molded plastics in the electronic and other fields show the range of the company's facilities.

## POSTWAR PRODUCTION DEVELOPMENTS

### Postwar Radio Models

Two manufacturers have let in a little light on postwar designs. First of these is Emerson Radio and Phonograph Corp., New York, which has made public that part of its plans having to do with four models—a compact set to retail in the neighborhood of \$25; a portable set at \$35; a phonoradio at \$85 and a pocket receiver at \$25. Tube complements and other engineering details have not been revealed. The other manufacturer is Galvin Mfg. Co., Chicago, which has let out some details of its new automobile sets. The new Motorola sets will be smaller, have better tone and more volume, considerably improved signal to noise ratio, interchangeability of parts, simpler setting of push buttons without tools. Both companies plan production as soon as WPB restrictions permit.

### Garstang Heads Electronic Labs.

Several changes have been made in the officers and directorate of Electronic Laboratories, Inc., Indianapolis. William W. Garstang, who has been vice-president and general manager has been elected president of the company, replacing Norman R. Kevers who moves up to chairman of the board. Three men have been elevated to vice-presidencies: Walter E. Peek, sales manager; Paul H. Frye, chief engineer; Harry C. May, works production manager. Other officers include Treasurer Thomas D. Scheidler and Secretary William J. Lochhead.

### Television As A Career

A four page pamphlet titled "Television as a Career," with a bibliography of recent literature on television and illustrated with pictures taken at Station WRGB, has been prepared by the transmitter division of the General Electric Co.

### Brochures For Industry

Walker-Jimieson, Inc., at 311 South Western Ave., Chicago, has published a series of brochures listing various types of industrial equipment. The brochures are designed to acquaint industrials with various types of equipment available for improving production, inspection and research facilities. Among the titles are Voltage Supply Equipment, Lighting Equipment, Shop Tools and Equipment, Sound Equipment, Electrical Maintenance Equipment and Test and Inspection Equipment.

### Postwar Meissner Radio-Phono Unveiled

The first postwar electronic radio-phonograph produced by the Meissner Mfg. Div., Maguire Industries, Inc., was unveiled in Chicago on August 1. Features of the phonograph portion of the set are high-fidelity reproduction of recorded music, an eight-key tone control system covering the entire range of human hearing, an automatic record changer which enables the instrument to play for two hours without attention, and a multiple speaker system. Radio features include regular broadcast, frequency-modulation and super short wave reception. Cabinets in the line are authentic period designs as well as modern patterns in woods and other materials especially suited to each type. The Meissner Mfg. Co., founded in Chicago in 1922, became a part of Maguire Industries, Inc., New York, late in June of this year.

### FM Xmitter Converters

Application to construct 30 FM converters under the "spot authorization" program has been filed with the War Production Board by Radio Engineering Laboratories of Long Island City, N. Y. The application is being processed by WPB authorities in Washington, D. C., and official O.K. on the request is expected this month. The converters are a means of dual frequency FM broadcasting. REL officials revealed that they have on file more than 60 orders for the new units.

### Magnetic Ingot Iron

Special advantages of Armco magnetic ingot iron which make it suitable for dc applications are presented in a new 24-page booklet just published by the American Rolling Mill Co., Middletown, Ohio. The booklet describes this product as a dense, highly refined open-hearth iron with high conducting power ideal for many electrical and magnetic applications. Products in which this special iron is used to advantage range from magnetic cores for cyclotrons to telephone and telegraph wires for communication systems. It is also a conductor of current in various kinds of electrical transportation equipment. The book contains data on the effect of strains on magnetic properties; hot and cold-working; machining operations with the aid of standard tools; and accepted methods of welding, including tables on the best electrodes to use.

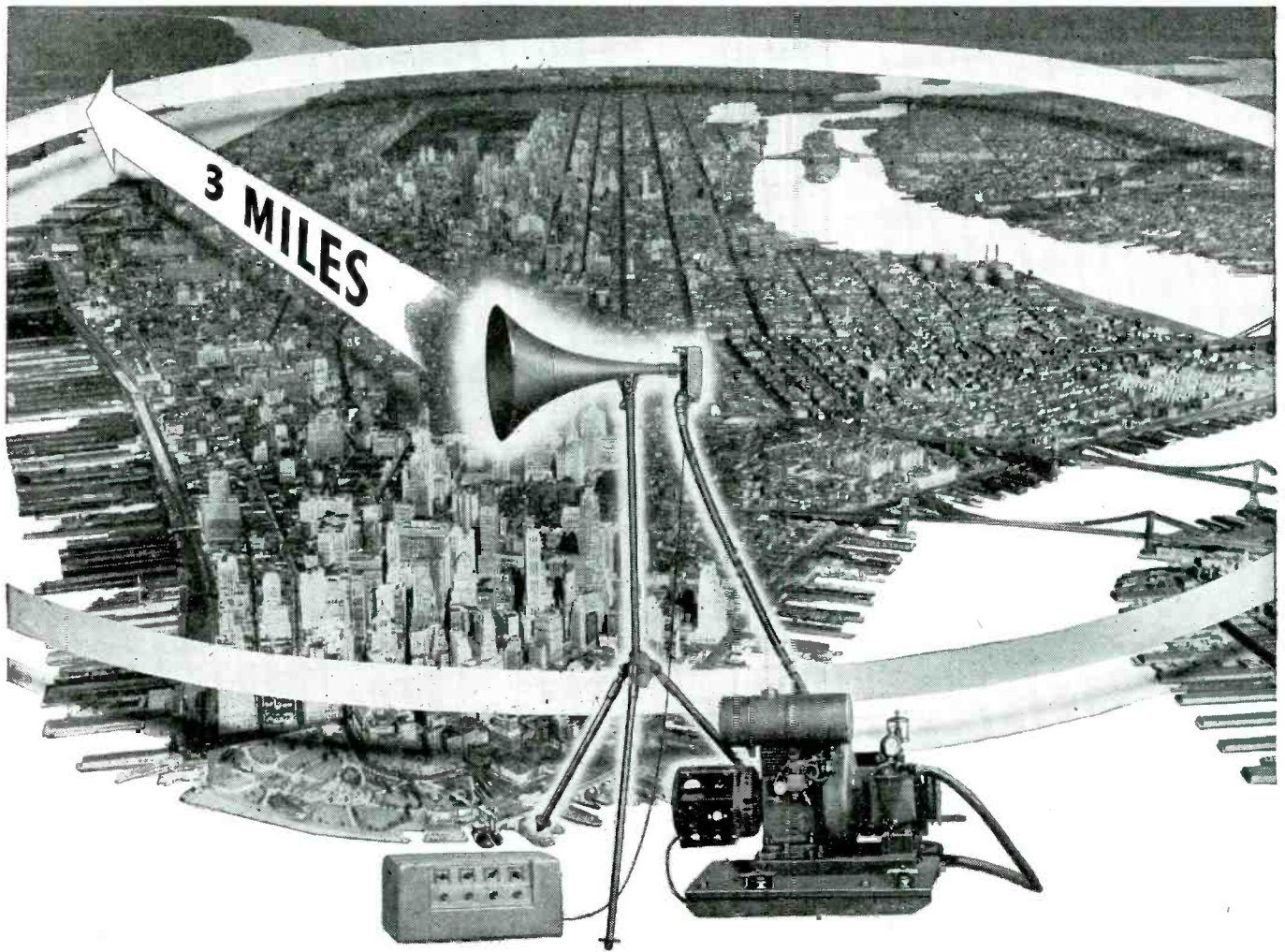

# COVERAGE — 28 SQUARE MILES!

## Only the G-E Super-Aire Speaker Can Do It

A NEW, powerful voice in industry is now available. It's the G-E Super-Aire speaker with a range of three miles, for use in far-flung operations where you want action . . . coordinated action . . . immediate action.

It can be used in such widely diversified fields as: railroading, construction projects, surface mining, ranching, harbor control, public utilities, highways, motion picture directing, airports, etc.

Amplified sound is provided through air pressure in such volume that it cuts through surrounding noise, wind, and air resistance with razor-edge sharpness; sound in such volume that clear, intelligible speech can be

delivered to a point three miles distant. Instructions can be delivered without miles of communication lines. The Super-Aire speaker can also be used in locations where conventional and complicated public address systems, much more expensive, would otherwise have to be installed.

Its simplicity and economy will appeal to those whose operations cover vast areas. Four basic elements, horn and driver unit, air compressor, power supply, audio amplifier—all built for hard usage—provide a completely portable system. The required audio input of less than 25 watts is all that is needed to step up the

sound level to its peak output—and the three-mile range.

The Super-Aire speaker is rugged right down to the voice element, which will not fracture, even if subjected to terrific shocks and vibration.

Write for complete information to: *Electronics Department, Specialty Division, General Electric, Syracuse, N. Y.*

See your G-E distributor for *Universal Radio Parts, P. A. Systems, Crystals, Receiving, Industrial and Transmitting Tubes, Laboratory and Service Test Equipment.*

**GENERAL**  **ELECTRIC**

166-D1

Electronics Department  
General Electric  
Syracuse, New York

E19

We are interested in further information concerning the G-E Super-Aire speaker for  Our own use  Resale Distribution

Name.....

Company.....

Address.....

Build longer life, better performance, into your products ... for war or peace ... with

# SPERTI HERMETIC SEALS

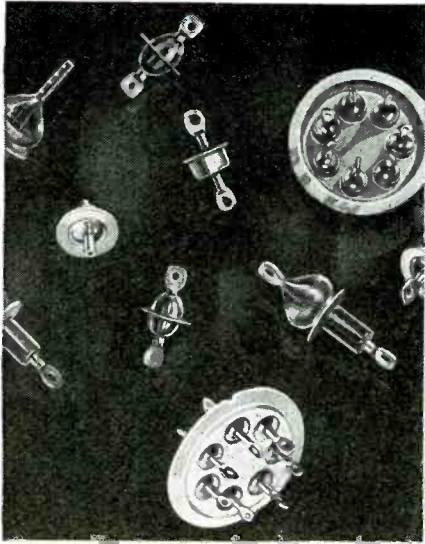

Right now, your first problem may be to meet rigid Army-Navy specifications in your electrical equipment. But as you turn to peacetime production, competition will have the same effect on quality standards as tough battle conditions.

Be prepared to build longer life, better performance into your peacetime as well as wartime product. You can—with Sperti Hermetic Seals. Rugged. Dependable. Proved in such vital war products as meters, transformers, condensers, relays, vibrators.

Sperti's advanced manufacturing methods plus exhaustive tests and inspections not only mean a better product for you ... but also save production delays, costly rejections.

WRITE, TODAY. Get the facts. Let us show you both the wartime and peacetime applications and advantages of Sperti Hermetic Seals.

## HERE'S WHY LEADING MANUFACTURERS CHOOSE SPERTI HERMETIC SEALS

- Seal out dust, fungus, salt spray, sand atmosphere at high altitudes, etc.
- Will add longer life to a product.
- Will help reduce operational troubles.
- Are one-piece, rugged units. Easily soldered-in at less expense.



# Sperti

INCORPORATED  
CINCINNATI 12, OHIO

RESEARCH • DEVELOPMENT • MANUFACTURING

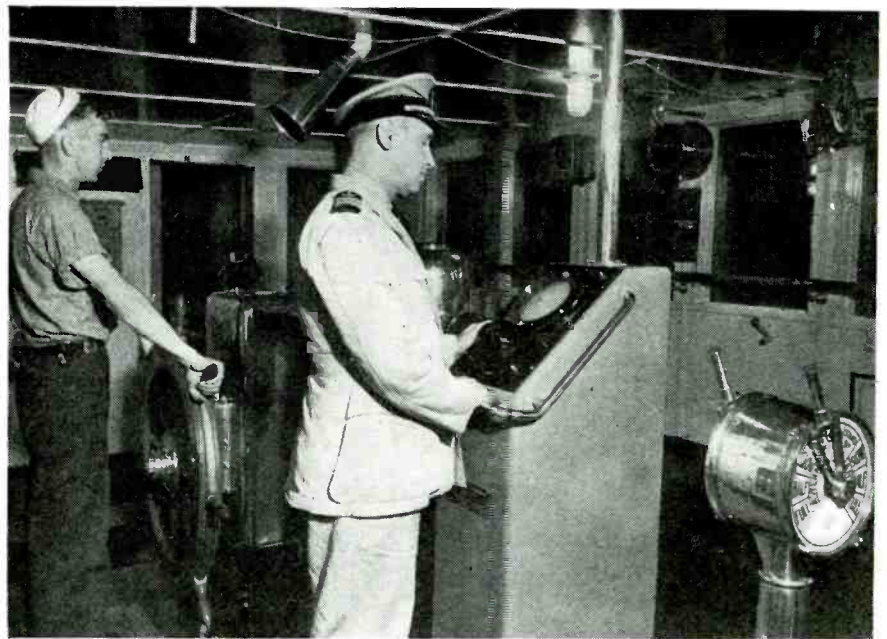

General Electric's peacetime application of radar principles to navigation permits shadow pictures of obstructions to appear on the cathode ray tube screen, is adjustable as to range

## RADAR DEVELOPED ELECTRONIC NAVIGATOR

Revealing the first commercial application of radar principles, the General Electric Co., middle of August, made public some details of its electronic navigator for marine use. The equipment, making use of pulsed microwaves, functions on the now familiar echo principle upon which radar is based.

The equipment is a compact installation installed in a single pedestal adjacent to the steersman's position in a ship. In operation, shadow picture of obstructions to navigation and of complete shore lines as far distant as 30 miles appear on the screen of the cathode ray tube. By means of manual controls, the navigator may adjust the scale of the field to cover either a 2-, 6-, or 30-mile radius.

Like all radar installations, the equipment utilizes an antenna which is constantly rotated, in this case, at 10 rpm. It is expected that the equipment which is planned to sell in the \$5,000-\$10,000 bracket will be of great usefulness in improving safety at sea, particularly for operation through fog and in stormy weather where normal visibility may be practically zero.

The G-E Electronic Navigator is capable of locating high and low shore lines at safe distances. It can spot vessels and buoys in ample time to alter a ship's course regardless of the vessel's speed. With it, it is possible to chart a safe course through fog-bound harbors and through congested ship-filled areas. It is a direct-reading instrument requiring no calculations for course determination. Non-technical personnel can readily master its operation.

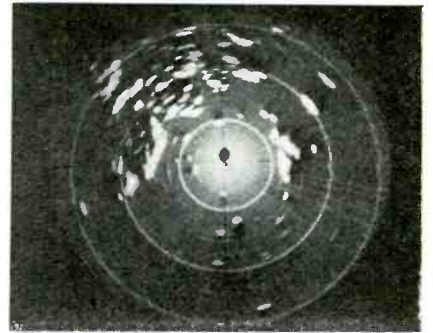

Photo of screen of electronic navigator in use showing indications of obstructions to navigation

### Spot Authorizations

Middle of August, WPB made its first spot authorizations for the production of home radio sets and other electronic equipment. Such authorization, however, does not pre-suppose priorities for materials, and production depends upon the ability of the manufacturer to find parts and man-power without disturbing what remains of war effort. Companies authorized follow:

Templeton Radio Mfg. Co. (radio sets) .....	\$120,000
Schulmerich Electronic, Inc. (amplifiers) .....	37,500
Kemp Equip. Co. (radio sets) .....	9,600
Universal Instruments Co. (test equipment) .....	24,000
Electronic Corp. of America (Radio sets) .....	100,000
Gen'l. Radio and Tele. Corp (radio sets) .....	110,000

### Thaw Xmitting Freeze

Within 60 days FCC's freeze on the construction of new radio stations is to be lifted. WPB has indicated that sufficient materials will be available by that time. The thaw will apply to all types of stations, AM, FM and television.

# ELECTRONIC BRAZING

## UNIT

with

## 24 Station

## INDEXING

## Work Carrier



### Delivers 5 Complete Assemblies Per Minute



HERE'S a striking example of how Scientific Electric Engineers increased brazing production output by designing a special automatic machine to operate in conjunction with Electronic heating.

A manufacturer of weather-proof control box covers was already using electronic heat to speed up production in the brazing operation involved. But greater production was urgently needed. Each assembly was being inserted and removed from a single heater coil . . . one at a time.

To increase output Scientific Electric engineers designed this compact circular, 24 station indexing work carrier which operates from the 18 KW electronic generator at the left.

The operator merely loads the stations as they come around empty. Heat is applied by three water-cooled induction coils under three of the work positions. The coils are followed by the vertically operating ejecting mechanism and a complete assembly is ejected from the carrier each 12 seconds.

The carrier, which is operated by a small motor can be applied to any of our electronic generators depending upon the heat input requirements of the work to be handled. Normal output of the unit illustrated is at 200 to 600 kc.

Workpiece output up to 20 per minute can be obtained and carriers, custom tailored to your requirements, can be delivered within 30 days. Send us your requirements today.

Scientific Electric Electronic Heaters are made in these power sizes... and a range of frequencies up to 300 Megacycles depending upon power requirements.

3 KW	18 KW
5 KW	25 KW
7½ KW	40 KW
8 KW	60 KW
10 KW	80 KW
12½ KW	100 KW
15 KW	250 KW

## Scientific Electric

Division of

"S" CORRUGATED QUENCHED GAP COMPANY

119 MONROE ST.  GARFIELD, N. J.

Manufacturers of

Vacuum Tube and Spark Gap Converters Since 1921

Weighs less than an ounce . . .  
but releases the whole world of  
**Glorious Recorded Music!**

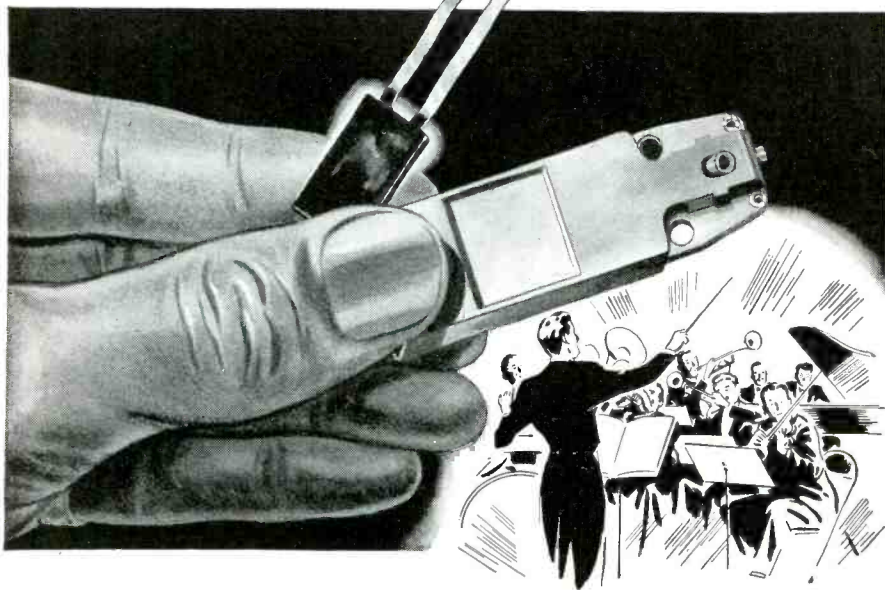

**N**O fully satisfactory recorded sound can issue from a radio-phonograph speaker unless it is "picked up" with the utmost accuracy . . . the truest fidelity . . . by the tiny, sensitive, featherweight pickup—the true heart of record reproduction.

That is why so many makers of the highest quality radio-phonograph combinations build Webster Electric Pickups into their original equipment. Webster Electric Crystal Pickups—backed by vast engineering experience and skill in the field of sound reproduction—possess remarkable range, precise balance for the right needle pressure, light weight, most modern styling . . . The most critical music lovers appreciate the rich tonal color, the delicacy of shading, the utter faithfulness of reproduction which Webster Electric Pickups give.

You will want to know all about Webster Electric Pickups, and how they can be of value in the development of your new products and equipment. Write us for full information today.

Let's All Back the Attack  
Buy Extra War Bonds



(Licensed under patents of the Brush  
Development Company)

**WEBSTER ELECTRIC**

Racine, Wisconsin, U.S.A. • Established 1909 • Export Dept.: 13 E. 40th Street, New York (16), N.Y. • Cable Address "ARLAB" New York City

"Where Quality is a Responsibility and Fair Dealing an Obligation"

**RIGHT OFF THE SHELF!**

Radio-Electronic Parts and Materials . . .

To fill your priority needs . . .

**IN A HURRY!**

*Dalis*  *Service*

'Phone, wire, or write . . .

**H.L. DALIS**

Wholesale Distributors  
RADIO-ELECTRONIC SUPPLIES & PARTS

17 Union Square  
NEW YORK 3, N. Y.

Phones: Algonquin 4-8112-3-4-5-6-7

**Because Accuracy Hangs in the Balance**

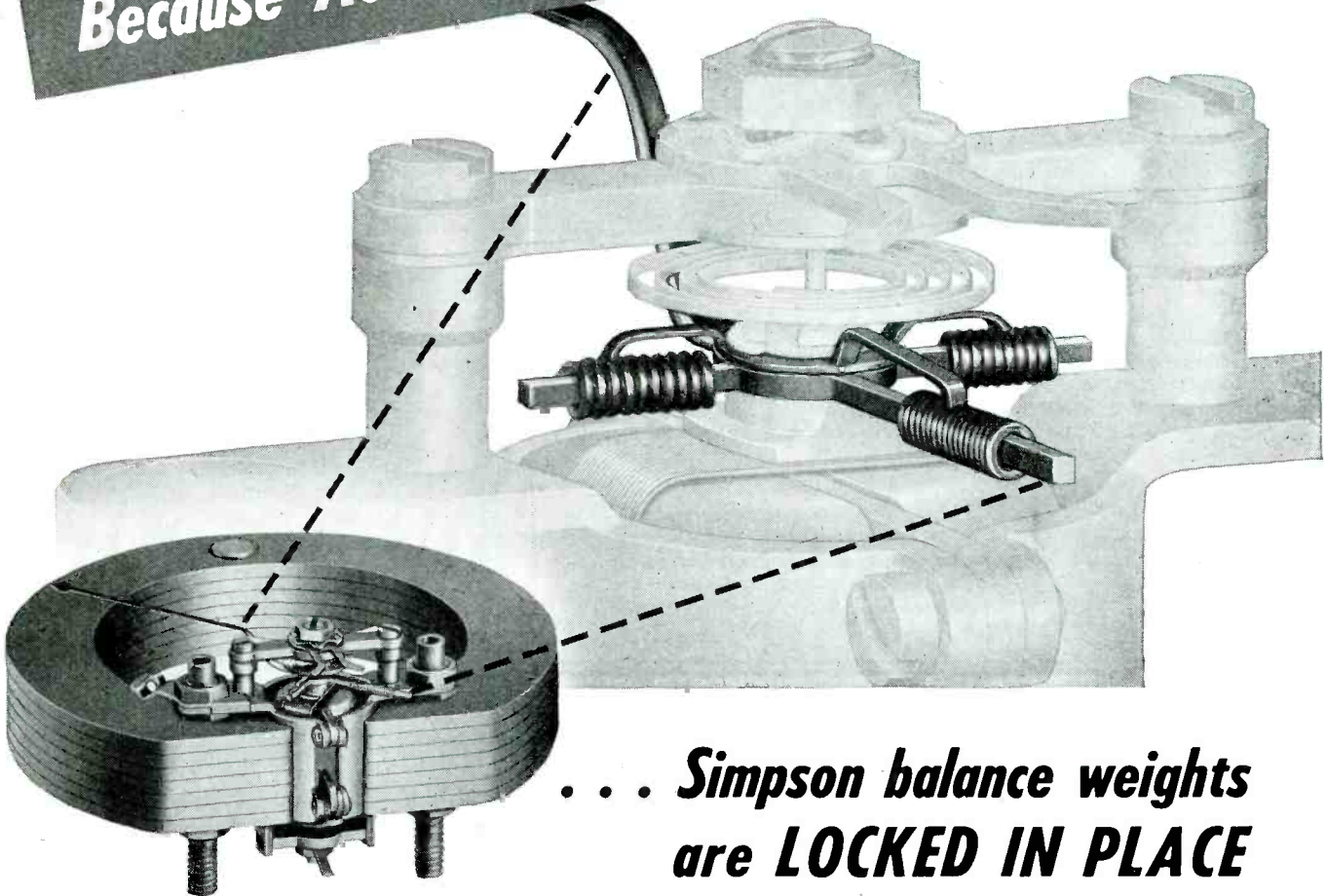

**... Simpson balance weights are LOCKED IN PLACE**

PERHAPS it's the smaller details, like these balance weights, that best illustrate the value of Simpson's 35 years of experience.

Though only tiny coils of wire, these balance weights have an important function—to offset the weight of the pointer so the moving assembly will swing in perfect balance. If the instrument is to stay accurate, they must stay in place.

So Simpson has devised a method of locking these balance weights in position. This construction not only defeats vibration and shock, it per-

mits even greater initial accuracy and makes possible faster, more efficient production.

Such refinements come from a greater knowledge of the problems of instrument manufacture, and a greater fund of practical experience which can be applied to their solution. This is the simple reason Simpson Instruments are writing such an outstanding service record in posts of vital responsibility. This, too, is your guarantee of the ablest translation of today's advances in tomorrow's instruments.

SIMPSON ELECTRIC COMPANY  
5200-5218 Kinzie St., Chicago 44, Illinois

**Simpson**

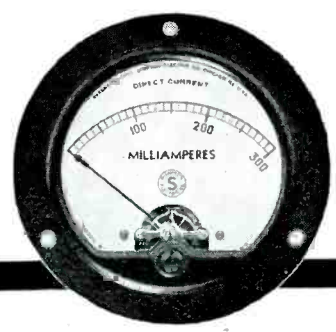

INSTRUMENTS THAT STAY ACCURATE

Buy War Bonds and Stamps for Victory

# PLUGS and JACKS

**... for every known application!**

Built in accordance with latest Signal Corps and Navy specifications, Amalgamated Plugs and Jacks are tropicalized to make them fungus resistant, waterproof and moistureproof when called for. Insulators of these components are designed to withstand extremes of temperatures for  $-67^{\circ}\text{F}$  to  $+167^{\circ}\text{F}$ , at humidities up to 100%. We also specialize in producing Plugs which will bear up under the high heat met in rubber molding cord sets.



**NOTE:** Amalgamated Engineers will gladly consult with you on the design and development of Plugs and Jacks for special applications—present or postwar.



## PLUG PL-55 and N.A.F. 1136-1

Long sleeve, two-conductor plug, mate to Jack JK-34-A. Withstands minimum of 60 cycles AC, potential of 500 volts effective, applied between any two terminals for not less than two seconds. Meets minimum insulation value of 2000 megohms between conductors at  $68^{\circ}\text{F}$  at humidities up to 100%.

## JACK JK-26, N.A.F. 215284-2

Two-conductor Jack, mate to PL-54, Tropicalized. Withstands 60 cycle AC potential of 500 volts effective, applied between any two terminals for not less than two seconds. Meets minimum insulation value of 2000 megohms between conductors at  $68^{\circ}\text{F}$ , at humidities up to 100%.



## PLUG, STYLE "A"

Two-conductor, special type plug for use with Neoprene or Buna S molded cords. Same specifications as PL-55.

## JACK JK-48

Light duty, two-conductor Jack, mate to Plug PL-291 and Plug 291-A.



## PLUG PL-204

Hand set. A special plug wherein both a modified plug, PL-55 and PL-68, are held in place by a phenolic case. Same specifications as PL-55 and PL-68.

## PLUG PL-54, PL-540, PL-354, N.A.F. 215285-2

Short sleeve, two-conductor plug, mate to Jack JK-26. Same specifications as PL-55.



## PLUG, STYLE "D"

Two-conductor, special type plug for use with Neoprene or Buna S molded cords. Same specifications as PL-55.

**AMALGAMATED RADIO TELEVISION CORP.**

476 BROADWAY • NEW YORK 13, N. Y.

## RADAR GLOSSARY

(Continued from page 214)

**Polyplexer (aircraft)**—A system for combining the operations of both duplexing and lobe switching in certain radar equipments.

**Polyrod antenna**—An antenna in which the radiating element is a rod of polystyrene. Similar to the action of a leaky wave guide.

**PPI scan**—Plan position indicator. The sweep is a radius of the tube face (from center of face), and moves around through 360 deg. It gives azimuth by direction of the radial line, and range by the distance of the signal from the center of the screen.

**Precision sweep**—A small portion of a normal sweep, usually 2,000 yards, selected and expanded over the entire screen in order to permit precise range measurements.

**PRF**—Pulse recurrence frequency.

**P-Scan**—See PPI-scan.

**Pulse transformer**—A special transformer designed to have a frequency response suitable for passing a pulse without materially altering its shape.

**Racon**—A radar beacon.

**Radome**—A general name for radar turrets which enclose antenna assemblies.

**Range mark**—A mark on the CRT screen which indicates distances from the radar set of the various echoes appearing on the screen of the CRT.

**Rapid scanning**—The use of narrow beams in the horizontal plane, scanned 10 cycles per second or higher for application to gun-laying radar.

**RCM**—Radar counter measures.

**RDF**—Radio direction finding. British abbreviation for radar.

**Receiver gating**—Applying operating voltages to one or more stages of intermediate frequency amplification in a receiver during that part of a cycle of operation when reception is desired.

**Recovery time**—(1) Of receiver: The time required for the receiver to recover to half sensitivity, after the end of the transmitted pulse. (2) Of TR switch: Time required after an rf pulse has fired the gap in the TR switch, for the received signal to reach half its maximum amplitude.

**Resonant charging choke**—In modulators, denotes the inductor, which with the effective capacitance of a pulse-forming network, is used to set up an oscillation of a given charging frequency.

**Rotary spark gap**—A device in which several electrodes mounted on a wheel are rotated past a fixed electrode producing spark discharges periodically.

(Continued on page 226)



# Federal INDUSTRIAL POWER TUBES ARE PERFORMANCE-RATED

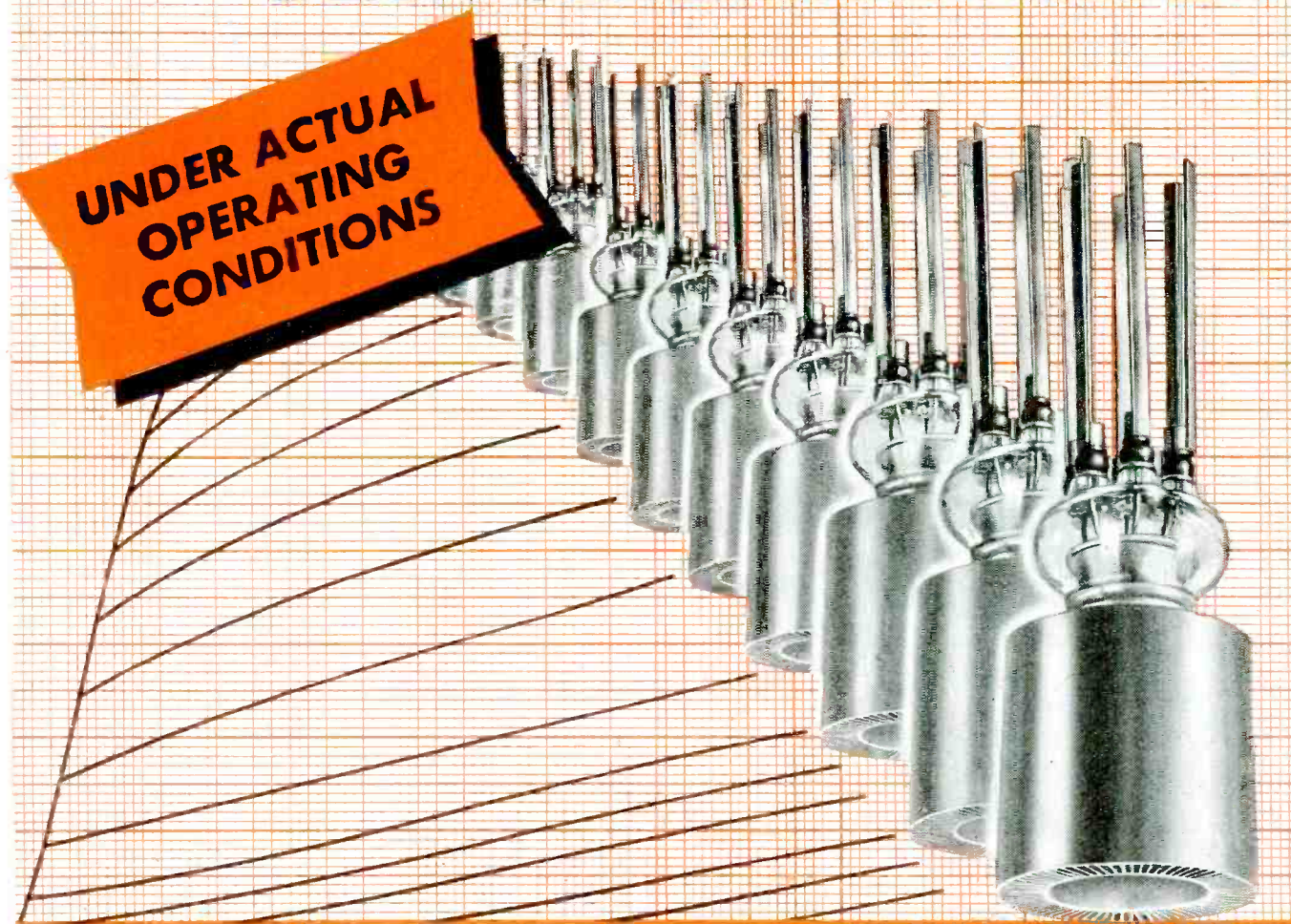

Federal Industrial Power Tubes are rated on the basis of actual performance under the same severe operating conditions found in industry . . .

Not from nominal design center values nor from operation under ideal conditions . . . but from actual tests in industrial heating equipment operating with and without work in the load circuit.

Federal tests include conditions where the character of the work changes during the heating cycle and each exacting test is designed to assure long

service and economical performance from every tube that bears the name . . . Federal.

Write for information about Federal's "better" industrial power tubes.

#### TECHNICAL DATA FOR TYPE F-7C25

Maximum Ratings for Maximum Frequency of 50 Mcs.	
DC Plate Voltage	3500 volts
DC Plate Current	1.25 amp
Plate Dissipation	2500 watts
Filament Voltage	11.0 volts
Filament Current	27.5 amps.
Overall Height	app. 7"
Maximum Diameter	3½"
Supplied with 6" flexible copper leads, 2 on each terminal	
Type of Cooling	Forced air
(Also supplied for water-cooling, type F-5302)	



*Federal Telephone and Radio Corporation*



Newark 1, N. J.

*Designed for*



*Application*

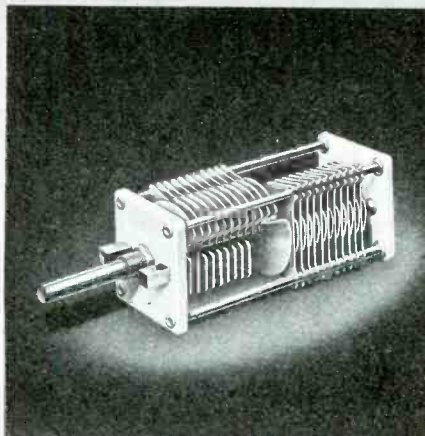

**The 28000-29000 Series  
Variable Air Capacitors**

"Designed for Application," double bearings, steatite end plates, cadmium or silver plated brass plates. Single or double section .022" or .066" air gap. End plate size: 1 9/16" x 1 11/16". Rotor plate radius: 3/4". Shaft lock, rear shaft extension, special mounting brackets, etc., to meet your requirements. The 28000 series has semi-circular rotor plate shape. The 29000 series has approximately straight frequency line rotor plate shape.

**JAMES MILLEN  
MFG. CO., INC.**

MAIN OFFICE AND FACTORY  
**MALDEN  
MASSACHUSETTS**



**WE TAKE THE  
WORRIES  
OUT OF YOUR  
HANDS!**

OUR  
SPECIALTY



**FABRICATING  
GLASS-BONDED  
MICA**

**IN ALL FORMS,  
to  
Specifications**

**COLONIAL  
KOLONITE COMPANY**  
2212 W. ARMITAGE AVE., CHICAGO, ILL.

**THERE'S A DRAKE  
SOLDERING IRON  
FOR EVERY TYPE OF  
ELECTRONIC WORK**

From that mighty mite



the Drake No. 400 to the high speed production "honey"



the Drake No. 600-10 there is a high quality Drake Soldering Iron "just right" for the job.

Drake Heat Controls and the Drake "Magic Cup" Stand are important soldering aids.



SEE  
**YOUR RADIO  
PARTS JOBBER**

**DRAKE ELECTRIC WORKS, INC.**  
3656 LINCOLN AVE. CHICAGO, ILL.

**FREE!**

NEW 11th EDITION

**RADIO'S  
MASTER**

*The only official  
Radio and Electronic  
equipment source-book*

**Tells you:**

**WHAT**

the product does, its specifications, comparable and competing items . . . Thousands of illustrations . . . Data covers 90% of all products in the industry, each item indexed and cross indexed.

**WHO**

makes it. Directory of manufacturers alphabetically listed, with page numbers for instant reference.

**HOW MUCH**

Prices on thousands of items, all clearly catalogued for easy buying.

**WHERE**

you can get it. Your nearest sources that can supply your radio and electronic requirements. Saves time . . . Eliminates bulky files.

**IMPORTANT**

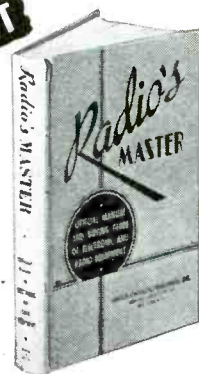

**Distributors  
from coast to  
coast have just  
bought quantities  
of this 800  
Page, hard-covered  
encyclopedia ready for  
free distribution.**

If you are an Engineer or Purchasing Agent WRITE FOR FREE COPY NOW.

★ Write us on your company letterhead and we'll put you in touch with the jobber nearest you who has your FREE Copy. No obligations.

Address Dept. FEP 2

**UNITED CATALOG  
PUBLISHERS, INC.**  
110 Lafayette St., New York 13, N. Y.

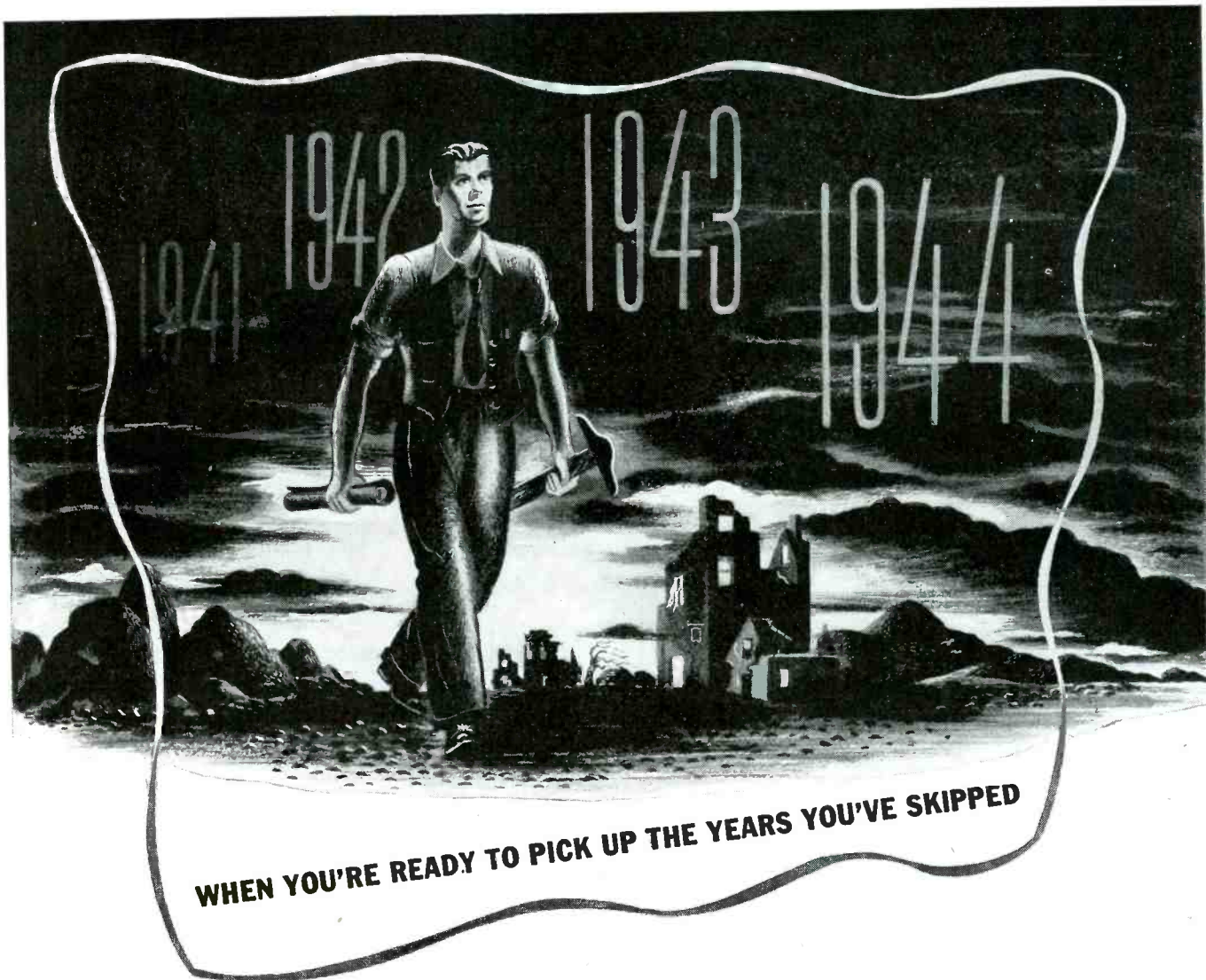

**WHEN YOU'RE READY TO PICK UP THE YEARS YOU'VE SKIPPED**

## **WESTON** CAN TELL YOU LOTS *That's NEW about Sensitive Relays!*

Many engineers concentrating on specialized war-time problems have had little opportunity to keep posted on all new developments in the electrical field. Many of these developments, too, could not previously be revealed for security reasons.

But now, with civilian activities in closer sight, these engineers will want to find out how far electrical science has moved forward in the years they have skipped.

In sensitive relays, for example, much has happened which will be of vital importance to design engineers. New sensitivities have been achieved by

WESTON . . . making available relays that provide positive control on extremely minute quantities of electrical energy. New compactness has been achieved, too; overcoming former space limitations through extremely small-size and light-weight.

To make sure that your post-war products, or manufacturing processes, are not handicapped by lack of knowledge about these new sensitive relay developments, ask the WESTON representative in your vicinity to quickly bring you up-to-date. Or, write direct to . . . Weston Electrical Instrument Corporation, 666 Frelinghuysen Avenue, Newark 5, New Jersey.



# **Weston** *Instruments*

ALBANY • ATLANTA • BOSTON • BUFFALO • CHICAGO • CINCINNATI • CLEVELAND • DALLAS • DENVER • DETROIT • JACKSONVILLE • KNOXVILLE • LOS ANGELES • MERIDEN  
MINNEAPOLIS • NEWARK • NEW ORLEANS • NEW YORK • PHILADELPHIA • PHOENIX • PITTSBURGH • ROCHESTER • SAN FRANCISCO • SEATTLE • ST. LOUIS • SYRACUSE

In Canada, Northern Electric Co., Ltd., Powerlite Devices, Ltd.

PUSH BUTTON • ROTARY  
AND TOGGLE SWITCHES

For Low Voltage  
Applications

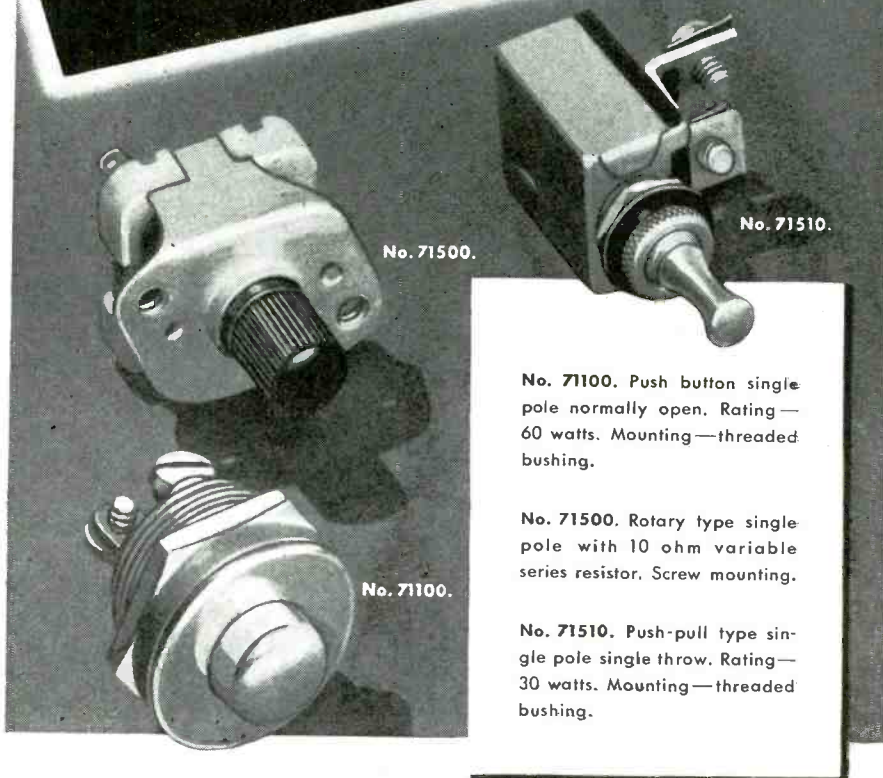

No. 71500.

No. 71510.

No. 71100.

No. 71100. Push button single pole normally open. Rating—60 watts. Mounting—threaded bushing.

No. 71500. Rotary type single pole with 10 ohm variable series resistor. Screw mounting.

No. 71510. Push-pull type single pole single throw. Rating—30 watts. Mounting—threaded bushing.

Here is a representative group of the extensive line of R-B-M electric control accessories... push button, rotary, and toggle switches; slow make-and-break contacts... now available for general purpose low voltage applications. Maximum rating, 32 volts, A. C. and D. C. For complete specifications, write Department B-9....

**R-B-M MANUFACTURING COMPANY**  
Division of  
ESSEX WIRE CORPORATION  
LOGANSPORT, INDIANA

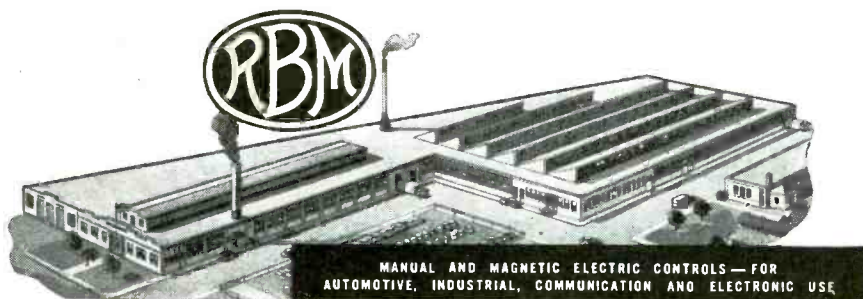

MANUAL AND MAGNETIC ELECTRIC CONTROLS—FOR  
AUTOMOTIVE, INDUSTRIAL, COMMUNICATION AND ELECTRONIC USE

## RADAR GLOSSARY

(Continued from page 222)

**Searchlighting**—Projecting the radar beam continuously at any given object of target, instead of illuminating it once during each scan period.

**Sheppard tube**—The Sheppard-Pierce tube, a trade name for all metal velocity modulation tube.

**Spark-gap modulator**—A modulator in which the high current switch takes the form of a spark gap. The spark gap may be either of the triggered or the rotary type.

**Spectrum analyzer**—A test instrument used to show the distribution of the energy contained in the frequencies emitted by pulsed magnetrons; to measure the Q of resonant cavities or lines; and to measure the cold impedance of a magnetron.

**Spiral scanning**—A type of antenna rotation in which a point on the rf beam traces out a spiral. Only a small sector in the desired direction is illuminated.

**Stabilization**—A system for maintaining a radar beam in a desired direction in space despite the roll and pitch of the ship or aircraft.

**Synchroscope**—An oscilloscope on which recurrent pulses or waveforms may be observed, which incorporates a sweep-generator that produces one sweep for each pulse, regardless of frequency, thus allowing no more than one cycle to be viewed on the screen.

**Time flutter**—Variation in the synchronization of components of a radar system, leading to variations in the position of the observed pulse along the time base, and reducing the accuracy with which the time of arrival of a pulse may be determined.

**Timer**—That part of the radar set that initiates pulse transmission and synchronizes this with the beginning of indicator sweeps, timing of gates, range markers, etc.

**Transponder**—The unit of the IFF system which receives the interrogator signal and automatically transmits the reply.

**TR Switch**—Transmit - receive switch. A switch which prevents the transmitted energy from getting to the receiver, but allows the received energy, which is much weaker, to reach the receiver without appreciable loss. This is necessary when the same antenna is used for both transmission and reception.

**Triggered spark gap**—A fixed spark gap in which the discharge passes between two electrodes and is struck (started) by a subsidiary electrode, the trigger, to which low power pulses are applied at regular intervals from a pulse amplifier, thus closing the switch.

**Trigatron**—High pressure trigger

(Continued on page 230)

# Only CORNELL-DUBILIER could make this CAPACITOR



When a real capacitor problem arises, engineers turn to Cornell-Dubilier *first*.

For example: A recent large installation was planned involving thousands of KVA. Capacitors were required to operate continuously under unusual conditions with a maximum rise of 20° C.

C-D engineers went to work. They made a more compact capacitor capable of meeting all specifications and at the same time cut costs in half. The new units have been giving satisfactory service ever since their installation and more have been ordered by the same customer.

It is this special ability to tackle tough assignments and to come through with cost-cutting, "long-

life" solutions that you obtain when you call on Cornell-Dubilier.

We are constantly developing new, exclusive designs like this giant mica tank capacitor — watch for others! For cooperation on your capacitor applications or special designs, write Cornell-Dubilier Electric Corporation, South Plainfield, N. J. Other plants at New Bedford, Brookline, Worcester, Mass. and Providence, R. I.

## CORNELL - DUBILIER CAPACITORS

MICA • DYKANOL • PAPER • ELECTROLYTICS



New and improved design of oil filled industrial oscillator mica capacitor. Types 97A and 97B can handle a high KVA in one compact unit

## Ingenious New Technical Methods

Available Now to Industry in General

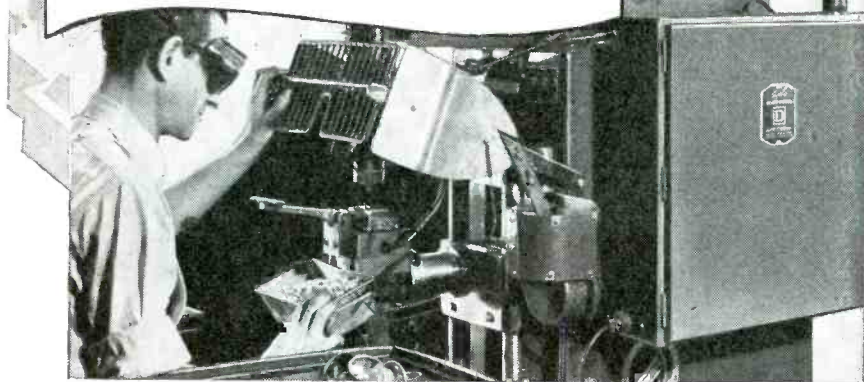

### Now! Projection Welding of Two Studs to Housing in One Operation!

The series of P-20 Peer Welders were developed to provide manufacturers of sheet metal and wire products with automatically air operated machines capable of high speed precision projection and general spot welding. They are sturdily constructed, low priced, direct air operated, press type machines.

Shown above, is a Peer P-20 set up with safety guard which is so adjusted that, when lowered, it trips the switch and causes the welder to pass through a complete welding cycle before the machine automatically lifts the guard and stops, ready for the next operation. Other means such as a foot-switch control, can also be used to actuate the welding cycle.

The standard cylinders furnished with these welders provide nominal electrode force up to a maximum of 1000 lbs. Pressures are easily adjusted by the air pressure regulating valve. The welders may be operated with strokes suitable for work at hand within the range of from 0" to 3".

Shown at right, is the wrapper from a package of Wrigley's Spearmint Gum. This famous wrapper will remain empty until conditions permit Wrigley's Spearmint manufacture in quality and quantity for everyone. Wrigley's Spearmint Gum, will, one day, be back as "a help on the job" to workers in industry. Until then, we ask you to remember this wrapper as a guarantee of finest quality and flavor in chewing gum!

You can get complete information from Pier Equipment Mfg. Co., 8 Milton St., Benton Harbor, Mich.

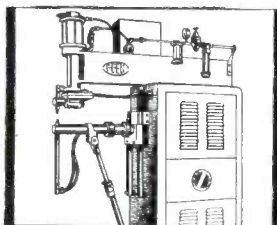

Air Operated Press Type Spot Welder



Remember this wrapper

Z-82

**DC**  
means  
**SC**

DC means SC... Selenium Control in suppression of inductive arcs. By proper selection of rectifier size, release timing of the inductive mechanism is positively controlled by the same unit which suppresses the arc. In relay applications where space is at a premium, the high voltage characteristics of the Selenium plate once again prove DC means SC... Selenium Control. If you use DC... get the facts on SC!

SEND FOR  
BULLETIN

**SELENIUM CORPORATION**  
of AMERICA

1719 WEST PICO BOULEVARD  
LOS ANGELES 15, CALIFORNIA

EXPORT DIVISION: FRAZAR & HANSEN  
301 CLAY STREET, SAN FRANCISCO, CALIFORNIA

IN CANADA: BURLEC LTD., TORONTO 13, ONTARIO, CANADA

**WANTED**

## Radio Design Engineers Electrical & Mechanical

Experienced in receiver design

FM and Television experience desirable but not essential

Good opportunity for future



**Emerson Radio**

& Phonograph Corp.

97 8th Ave., New York City

# A Positive Angle on Negative Angle Milling

How Kearney & Trecker  
Use

## MICRO SWITCH SNAP-ACTION

As Inching Switch on  
Milwaukee Milling Machine

WHEN Kearney & Trecker designed this big new 50 HP. C.S.M. Milwaukee Milling Machine, especially for negative angle milling, it was important that the inching switch, used for synchronizing gears, be rugged and dependable. A Micro Switch sealed plunger switch with a die cast housing was installed so that it is operated by an actuator head controlled by the inching button.

This switch was selected because it combined the precision, capacity, and durability required by the milling machine manufacturer. Micro Switch snap-action can be counted on for millions of operations, all equally accurate. There are over 2700 different combinations of switches, contacts, actuators, and enclosures.

Send for the Handbook-Catalog No. 60 shown at right—it gives specific, helpful information on Micro Switch products.

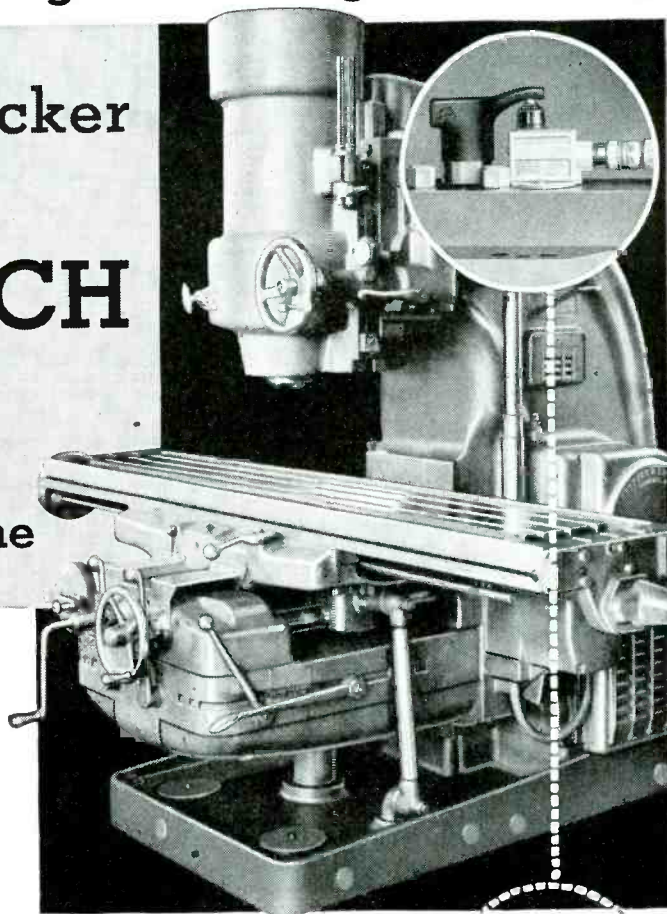

### How Inching Lever Works

The Micro Switch provides a convenient means for "inching" the spindle head to facilitate speed changes.

Operation of button "A" rotates the actuator head "B" through gear "C" causing it to wipe over plunger "D," thus momentarily operating the switch to "inch" the spindle motor.

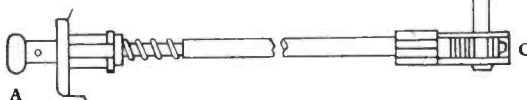
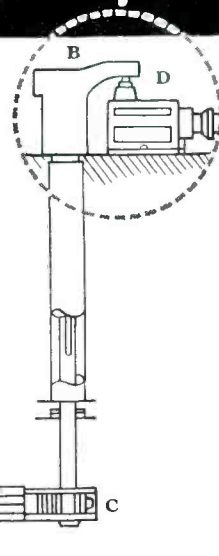

### Send for this free Handbook-Catalog

Gives complete details as to electrical characteristics, construction, dimensions, operations, and applications. If you are specializing in aircraft equipment, ask for Handbook-Catalog No. 71, also.

© 1945 First Industrial Corporation

**MICRO** MARK  
TRADE **MS** SWITCH

A DIVISION OF FIRST INDUSTRIAL CORPORATION

Freeport, Illinois, U. S. A., Sales Offices in Principal Cities

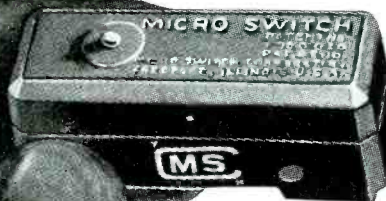

Buy  
More  
War Bonds



To  
Finish  
the  
Job!

The basic switch is a thumb-size, feather-light, plastic enclosed, precision, snap-action switch, Underwriters' listed and rated at 1200 V. A., at 125 to 460 volts a. c. Capacity on d. c. depends on load characteristics. Accurate reproducibility of performance is maintained over millions of operations. Basic switches of different characteristics are combined with various actuators and metal housings to meet a wide range of requirements.

FOR QUALITY

## RADELL-BUILT PRODUCTS

• It is easy to recognize the marks of superior craftsmanship in Radell-built electronic products. With a broad basic knowledge and advanced production skill, Radell Corporation is a versatile organization specializing in the assembly and sub-assembly of highest quality electronic products.

### COMPLETE FACILITIES FOR AUDIO WORK

**RADELL** CORPORATION

6323-37 Guilford Avenue, Indianapolis 5, Indiana

## New INLAY PROCESS

### ELIMINATES NAME PLATES ON FRONT PANELS

A proven method for placing durable characters on metal panels, chassis, etc.

- ★ Inlaid baked enamel characters, protected by background finish; resistant to abrasion and salt spray; guaranteed to pass 50 hour salt spray test. NOW available in luminous characters, if desired, either phosphorescent or fluorescent.
- ★ Front panel will match finish of cabinets.
- ★ Recommended and endorsed by scores of manufacturers of electronic, sound and communication equipment.

PROMPT DELIVERIES—Send us your bare fabricated steel and within two weeks we will return it finished and marked to your complete satisfaction

**SCREENMAKERS**

64 FULTON STREET • NEW YORK 7, N.Y.

Tel.: REctor 2-9867

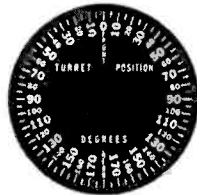
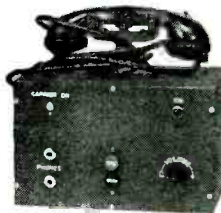

ALSO... SILK SCREENING on front panels and chassis, either metal or plastic. Sharp clear characters durably printed on finished or unfinished surfaces

## RADAR GLOSSARY

(Continued from page 226)

spark gap modulator.

**Windshield**—In radar, a streamlined cover placed in front of airborne paraboloid antennas to minimize wind resistance. The cover material is such as to present no appreciable attenuation to the radiation of the radar energy.

**Wuerzburg**—German fire control radar.

**Zero-time reference**—Reference point in time from which the operations of the various radar circuits are measured.

## AMERICANIZED-BRITISH RADAR

(Continued from page 92)

able to high-speed production. Either condition made it impossible to supply them fast in large numbers.

Several American manufacturers were appealed to. The tube was of the Lock-In type of construction, for which Sylvania Electric Products Inc. had been the pioneer. Because of that, Sylvania was in a position to meet the requirements, and proceeded to do so. Granted permission to modify the design, the company soon was producing the tubes at high speed, supplying several millions of them.

This tube had a wider use abroad in radar than had all other receiving tubes combined, and it played an important role in bringing the air war over England under control. Because of its unequalled performance at ultra high frequencies, it was used in 284 types of British equipment.

The original British tube employed many Lock-In features that were familiar to Sylvania engineers—cup header, single-ended operation, lock-in and glass-bead features, metal base shell and guide pin, one-piece, straight alloy leads, elimination of soldered connections and short, widely-spaced pins essential for UHF.

The chief differences between the Lock-In and the VR-91 was that the VR-91 is a nine-pin tube with a larger base and pin circle diameter. A change in machines was necessary since that size of base and number of pins was needed to fit the British socket. A practical duplicate of the British base construction was worked out to fit the Sylvania standard bulb, and a new set of molds was built to take the smaller size pins and different pin spacings of the VR-91.

Although the British tube was fundamentally like the Lock-In, it had more parts, different grid geometries, smaller wires, and was generally a more complicated design that could not be produced at high speeds. It was, therefore,

(Continued on page 234)



And now . . .

# MYCALEX

## 410

### PRECISION-MOLDED

**Newest and Greatest Advancement  
in Low Loss Insulation**

Just as sound advanced motion pictures and as television is advancing radio, so the new improved MOLDED MYCALEX will advance the cause of electronic engineers who seek ever-higher standards in insulating materials.

New and exclusive methods of MYCALEX CORPORATION now enable us to mold MYCALEX to far more exacting specifications . . . closer tolerances, with metal inserts molded in and other refinements.

Our technique affords a virtually endless variety of irregular shapes that compare with molded plastics for smoothness and precision. Yet MYCALEX offers so much more in electrical and physical advantages.

For example: greater strength and dimensional stability, freedom from cold flow, freedom from carbonization, imperviousness to moisture and gases . . . ability to withstand temperatures beyond 400 C.

Investigate the new uses and applications of this remarkable new advancement in MYCALEX. Get the facts about MYCALEX 410.



## MYCALEX CORPORATION OF AMERICA

*"Owners of 'MYCALEX' Patents"*

Plant and General Offices, CLIFTON, N. J.

Executive Offices, 30 ROCKEFELLER PLAZA, NEW YORK 20, N. Y.



... installs **SURCO THINWALL WRAP** after Rigid Testing

... the first uniformly high quality fine wire, plastic insulated with flame proofed yarn serving.

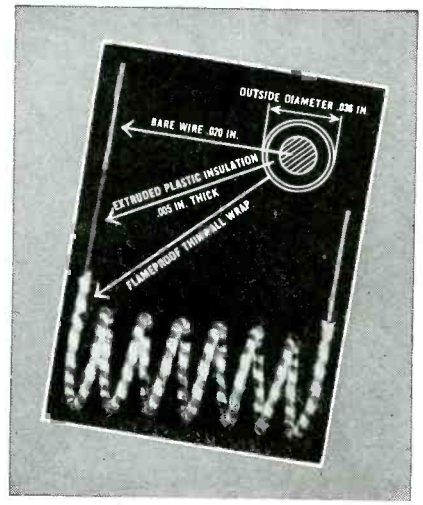

This photo of typical construction is absolutely unretouched

**Voltage Breakdown — 7000 Volts**  
 (For spiraled section shown in photograph after 5 minutes in water)  
**Insulation Resistance—30 Megs. Per 1000 Ft. at 60°F. (After 72 hrs. in water)**

Here are Thinwall's Characteristics: High dielectric properties, Maximum saving in space and weight, Unlimited coding and identification, High temperature operation, Excellent abrasion resistance and toughness, Maximum protection against damage by soldering iron, Unusual flexibility at below freezing temperatures, Flameproof qualities, Good end and spot-stripping characteristics, Low cost.

Surco-American Thinwall Wrap is available in a wide variety of formulations finer sizes of wire and thinner insulations than shown above, for use where maximum performance under specific operating conditions is required.

**Surprenant**  
 ELECTRICAL INSULATION CO.  
 Dept. O 84 Purchase St., Boston 10, Mass.

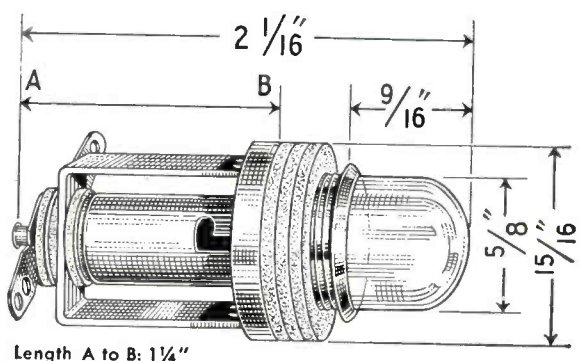

No. 51N

Length A to B: 1 1/4"

## New NEON Assembly With Plastic Dome

The clear colorless, plastic dome . . . a feature of the new Drake No. 51N permits the Neon glow to be observed from all angles. This new assembly accommodates the NE51 Neon glow lamp which gives longer life (3,000 hrs.), low power consumption (1/25 watt) and shock-proof construction. A built-in resistor

permits direct connection to 115 volt circuits. Furnished with three 1/16" thick fibre spacing washers which are removable when unit is mounted in thick panels thus keeping Neon glow at top of dome. The new No. 51N is only one of many fine Drake Socket and Jewel light assemblies; many incorporating patented features developed by our research staff. Do you have an up-to-date Drake catalog?



SOCKET AND JEWEL LIGHT ASSEMBLIES

**DRAKE MANUFACTURING CO.**  
 1713 WEST HUBBARD ST., CHICAGO 22, U.S.A.

IMMEDIATE DELIVERIES

## VACUUM TUBE VOLTMETER

RF — AC — DC



The result of 10 years of Vacuum Tube Voltmeter Engineering.

### MODEL VM-27

1-3-10-30-100 volts full scale. Peak response, r.m.s. calibration.

**HIGH IMPEDANCE**—4 megohms at 50 cycles, 60,000 ohms at 100 megacycles. 7 megohms for d-c.

**ACCURATE**—Better than 2 percent on d-c and 60 cycles thru 50 megacycles.

**SELF-CONTAINED**—115 or 230 volt 50-60 cycle line operation.

### RF PROBE

Interchangeable probe included for convenience and efficiency in making AC and RF measurements. Input capacity 5 micro farads. Ruggedly mounted 6H6 tube in balanced circuit. Complete voltmeter with probe \$150 net f.o.b. Flushing, N. Y.

**ALFRED W. BARBER LABORATORIES**  
 34-04 Francis Lewis Blvd. Flushing, N. Y.

### ACCESSORIES

To increase VM-27 range to 1000 volts.



### 10X AC MULTIPLIER MODEL ACM-27

Input impedance even greater than probe alone. Flat response from 20 cycles to 200 megacycles. \$17.00 net f.o.b. Flushing, N. Y.

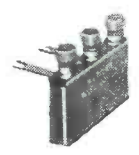

### 10X DC MULTIPLIER MODEL DCM-27

5 megohms input resistance. \$8.00 net f.o.b. Flushing, N. Y.

# "AEROTROLS"

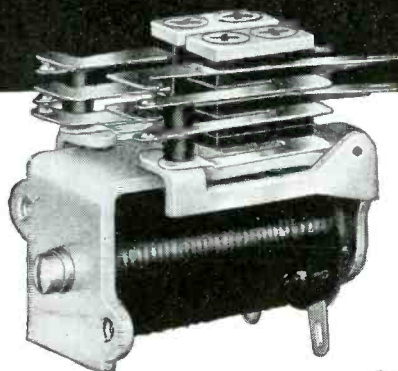

## *The Small Relays with the Big Performance*

• Engineered and manufactured for the necessities of military aircraft operation, Cook "Aerotrols" have opened new fields in electrical and electronic remote control applications in radio-radar, wire communications, mining, manufacturing, testing and innumerable other fields where greater dependability and accuracy must be provided.

• Here are some of the general specifications of the "Aerotrol" "400" Series relays. The size of the "Aerotrol" without springs (the frame, coil and armature) is  $1\frac{5}{16}$ " wide,  $1\frac{1}{16}$ " long and 1" high. Spring assemblies add to overall height, up to 1" for 6 springs. Average weight for two spring pile-ups is  $1\frac{3}{4}$  oz. The coil spool is one piece, moulded bakelite. Heel piece is arranged for two mounting screws with solder terminal for coil located at the armature end, at which end also, spring solder terminals are located. Coil winding capacity can be provided up to 10,000 ohms and for positive operation on current values as low as 2 milliamperes. Coil treatment normally includes impregnation

with fungus lacquer and Insulex covering, and where required, the coil is treated for high humidity and other tropical conditions.

• "Aerotrols" are small, compact, yet rigidly constructed relays that have proven their dependability, not only in laboratory tests, but in actual operation under the most severe wartime conditions all over the world.

• "Aerotrols" are "application engineered" to provide specific performance suitable to circuit and control conditions. There are many selective features that can be incorporated into these relays. Bushings and insulators can be provided made of Cook patented "Cecotite" ceramics, to provide freedom from carbonization and wear, and to provide permanent stability of original adjustment and rapid frequency of operation. Mounting arrangements can be provided to meet installation conditions, including the plug-in types.

• "Aerotrols" of various types, such as time delay, latching, A.C. or D.C., both single and double pile-ups, can be supplied.

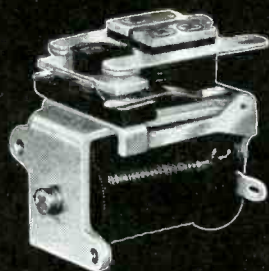

Illustrated above is an "Aerotrol" heavy current relay, with two Form "A" contacts operating on a double armature.

SEND FOR BOOKLET AR-145 FOR INFORMATION ON THE COMPLETE LINE OF "AEROTROL" RELAYS.



Illustrated above is a latching type "Aerotrol" combining two type "401" "Aerotrols." Any combination of the "400" series relays can be combined into a latching "Aerotrol."

**COOK ELECTRIC**  
Company



CHICAGO 14, ILLINOIS

# GROVES

## wire wound RESISTORS

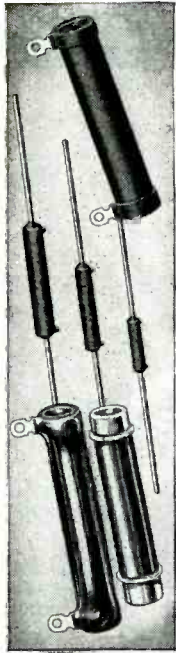

GROVES RESISTORS, both wire wound and precision types, are accurately designed for long life and efficient performance, under severest conditions.

Wire wound Resistors comprise Type Z with coating of an especially developed organic cement, and Type V with coating of high quality vitreous enamel.

Precision Resistors, non-inductively wound on high quality ceramic spools, are effectively processed to withstand high humidity conditions. Moisture and fungus resistant. Constructed in accordance with the joint Army and Navy specifications. 3 types immediately available.

Catalog upon request.

**GROVES**  
CORPORATION  
CAPE GIRARDEAU MISSOURI



## AMERICANIZED-BRITISH RADAR

(Continued from page 230)

necessary to strengthen and simplify the British tube to obtain a more manufacturable product.

The No. 1 grid wire diameter was changed from one mil to two and a half mills, which increased the strength nearly forty times. The grid geometry was also changed from diamond-shaped to "formed" to facilitate grid making. The No. 2 grid was changed from oval to hexagonal, also for greater strength and speed of manufacture. The two-piece plate was changed to one-piece wrap-around. This change increased its strength and stepped up the manufacturing speed four times. To save on critical materials, the shield and plate were changed from carbonized nickel to carbonized plain steel and nickel-plated steel. Altogether there were seventeen major changes made in the British design, including grids, micas, getter, connectors, mount support, shield and methods of testing.

Two of the most important techniques of bulb manufacture, which are envelope and stem-making, had been reduced to scientific control during development of the Lock-In. The British tube used an alloy pin material and the Lock-In had initially been made with that alloy. A glass also had been developed to be used specifically with that alloy on Sylvania equipment, and a production method of oxidizing the alloy had been perfected. Materials used in the envelope of the VR-91 were well known and had been used on the Lock-In.

High-speed stem-making and sealing techniques had been perfected also on the Lock-In, and that knowledge was made use of in manufacturing the VR-91. This was particularly true in control of strain, and in general glass quality.

The tube has its own external shield grounded through the center lug as well as internal shielding brought out on two terminals for better grounding. At frequencies from 20 mc up it gives particularly good performance in broadband i-f and r-f amplifiers.

## FLYING TELE-FM

(Continued from page 95)

range of an antenna located 30,000 ft. in the air. Thus power to operate all nine transmitters and all monitoring and relaying equipment can be provided by each plane's engines.

"The system would bring television and FM to millions of new viewers' and listeners, but, in addition, it would greatly improve these services for audiences—old and new. A distinct improvement in service

(Continued on page 238)

## C. T. C. TURRET TERMINAL LUGS



**For Firm,  
Quick Fastening,  
Swift Soldering  
Terminal Posts**

Just swage them to the terminal board and you have strong, well anchored terminal posts. Two soldering spaces permit wiring of two or more connections without superimposing wires. Soldering is swift because sufficient metal is used in Lugs to provide strength,

but there's no surplus metal which would draw heat and thus slow soldering.

Made of heavily silver plated brass, C. T. C. TURRET TERMINAL LUGS are stocked to fit 1/32", 2/32", 3/32", 4/32", 6/32" and 8/32" terminal boards.



Write for C. T. C. Catalog No. 100



**CAMBRIDGE THERMIONIC CORPORATION**  
441 Concord Avenue • Cambridge 38, Mass.

# NEED

# MICA CERAMIC INSULATION?



One of several batteries of precision presses for injection and compression molding Mykroy. Here are produced a large percentage of all milled mica ceramic parts required for the war effort.



In this, the largest exclusive mica ceramic fabricating plant in the world, Mykroy is machined to customer's specifications on rapid delivery schedules. Mykroy can be shaped to extremely close tolerances.

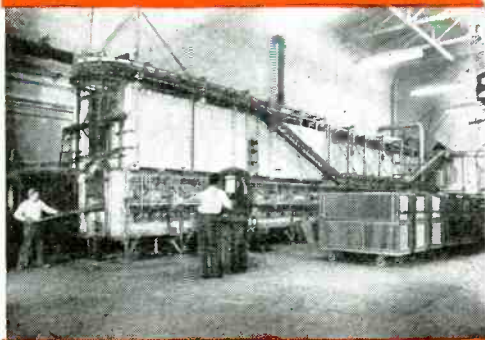

The largest sheets of mica ceramic insulation available (19 1/4 x 29 3/4) made only by Electronic Mechanics, are produced in this firing kiln followed by 12 to 36 hour annealing in the Lehr. This removes all internal stresses and strains in the sheets assuring great physical stability.

order

# MYKROY

PERFECTED MICA CERAMIC INSULATION

from

## ELECTRONIC MECHANICS...Largest Manufacturer and Fabricator of Glass Bonded Mica Insulation

IT IS now recognized by leading engineers and manufacturers that Mykroy . . . the perfected Glass-Bonded Mica Ceramic, is one of the best and most usable insulating materials yet developed for general and high frequency applications. They also know that Electronic Mechanics, exclusive manufacturer and fabricator of Mykroy, is a very dependable source of supply. Whether it is required in sheets—rods—machined or molded to specifications, Mykroy is delivered on time!

Mykroy speaks for itself. Although there are several brands of Glass-Bonded Mica Insulation there is a vast difference between them. Exacting tests conducted by independent testing laboratories and government agencies on samples of Mykroy picked at random from production runs have proved its superiority. (Meets L4 specifications and is approved for Army and Navy equipment.) *That is why Mykroy outsells all other brands combined!*

Electronic Mechanics, now in its tenth year, is a company of nationally known electronic engineers, who have specialized in research devoted entirely to improving the formulas and methods of processing Mykroy . . . to perfecting this extensively used high frequency insulation.

The stability of Mykroy and the company behind it are your positive assurance of superior insulation and dependable deliveries. If you have used Mica Ceramic Insulation and need more, send us your order. We'll take care of it promptly. If it's new to you, write for a sample and a complete set of Mykroy Engineering bulletins.

MADE EXCLUSIVELY BY

**ELECTRONIC MECHANICS**  
INC.

70 CLIFTON BLVD., CLIFTON, N. J.  
CHICAGO 47; 1917 N. Springfield Ave., Tel. Albany 4310  
EXPORT OFFICE: 89 Broad Street, New York 4, New York

MYKROY IS SUPPLIED IN SHEETS AND RODS — MACHINED OR MOLDED TO SPECIFICATIONS

# HIGH VACUUM GAUGES

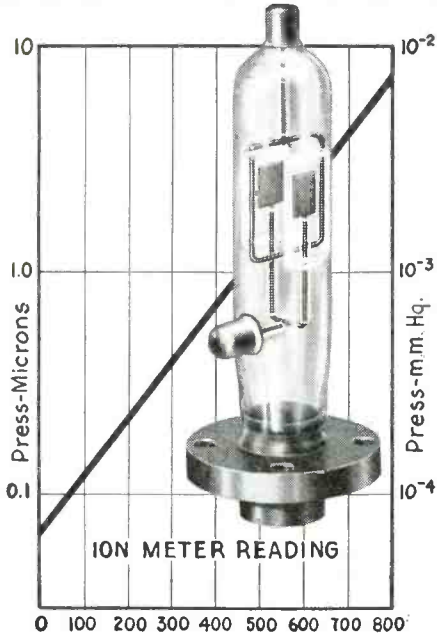

## IONIZATION GAUGE COLD CATHODE TYPE

Measures high vacuums with galvanometer down to  $10^{-4}$  mm. Hg. in electron microscopes and other high vacuum apparatus. Utilizes discharge current between electrodes in magnetic field. Extremely sensitive and accurate.

The Universal line includes two types of vacuum gauges of special interest to users of electron microscopes—the Universal highly sensitive cold cathode ionization gauge and the rugged Universal thermocouple gauge.

Both gauges are standard equipment on R. C. A. electron microscopes—and can be supplied for other high vacuum work.

Universal offers a complete production service in special glass and tube work—including metal-to-glass seals of all types and sizes. Your problems will receive our immediate and courteous consideration.

## THERMO-COUPLE GAUGE

Measures low pressure levels with millivoltmeter which indicates variation in thermocouple voltage due to changes in vacuum. Ideal for systems requiring rapid verification of high vacuums. Heater and instrument terminals fit standard 8-prong tube socket.



**UNIVERSAL X-RAY PRODUCTS INC.**  
1800-B N. FRANCISCO AVENUE • CHICAGO 47, ILLINOIS

# WOKMAR

*Manufacturers of*

**RADIO, ELECTRICAL AND  
ELECTRONIC COMPONENTS**

**ELECTRONIC PRODUCTS MFG. CORP.**  
DEXTER, MICHIGAN

# WIRE, RIBBON and other METAL PRODUCTS

- Smaller than Commercial Sizes
- Closer than Commercial Tolerances

**PLATINUM • RHODIUM • IRIIDIUM  
PALLADIUM • RUTHENIUM  
and ALLOYS**

*Commercial Purity and High Purity  
WIRE, SHEET, FOIL, TUBING*

- Wire for Resistance Thermometers
- Rhodium Electroplating Solutions
- Platinum for Electronic Tubes
- Rhodium First Surface Mirrors
- Alloys for Contact Points
- Wires for Detonator Fuses
- Dental Metals and Alloys
- Wires for Thermocouples
- Tubing for Ink Devices
- Wire for Pirani Gauges
- Spark Plug Electrodes
- Wollaston Wire
- Duro Palladium

**BASE METALS • RARE METALS  
PRECIOUS METALS and ALLOYS**

- Galvanometer Suspension Strips
- Platinum-Covered Grid Wire
- Gold Covered Silver Wire
- Gold Cyanide for Plating
- Special Melts and Alloys
- Gold Covered Grid Wire
- Small Spring Ribbon
- Electroplated Wires
- Ribbon, All Metals
- Molybdenum Ribbon
- Tungsten Ribbon
- Filament Ribbon
- Filament Wire
- Fuse Wire
- Grid Wire

Write for List of Products and Data

**SIGMUND COHN & CO.**



44 GOLD STREET NEW YORK 7

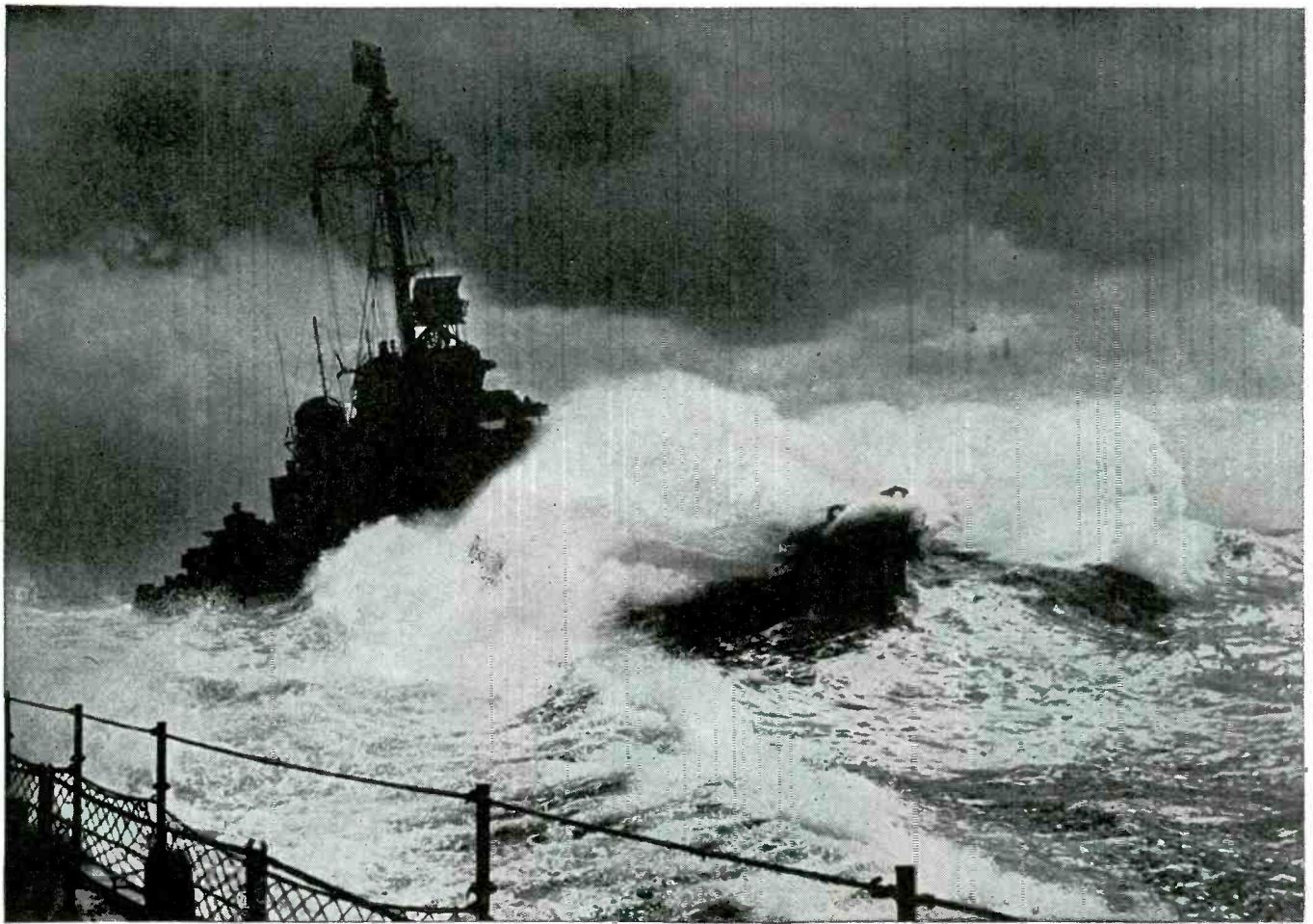

OFFICIAL U. S. NAVY PHOTO

## Any port in a storm ... but there are no ports

More than one sailor has said, "It's a helluva place to fight a war!"

That's a miracle of understatement when you know the Pacific as well as the U. S. Navy knows it.

They know how many thousands of miles you have to go before you reach the fighting fronts.

They know there's almost continual rain and bad weather to hamper operations after you get there.

*And they know there are no good ports!*

Think of the thousands of ships, and the millions of tons of supplies it takes to keep our fighting forces moving toward Japan.

Imagine, if you can, the problem of handling those ships and supplies with no port facilities.

There are no giant cargo cranes...no miles of docks and warehouses...nothing but beaches, and human backs, and a refusal to call any job impossible.

Remember, too:

**It takes 3 ships to do the supply job in the Pacific that 1 ship can do in the Atlantic.**

**It takes 6 to 11 tons of supplies to put a man on the Pacific battleline, and another ton per month to keep him supplied.**

**It takes a supply vessel, under ideal**

**conditions, half a year to make one round trip.**

Add up those facts, multiply by the number of sailors, soldiers, and marines for whom the Navy is responsible.

Maybe you'll begin to realize what "no ports" can mean in the rough, tough waters of the Pacific.

Maybe you'll see that we have *two* reasons to be proud of the U. S. Navy. *First*, the way they've sunk the enemy's ships.

*Second*, the way they sail *your* ships... taking the worst the Pacific can hand them...but keeping the supply lines open...keeping the attack *on schedule!*

**SPERRY GYROSCOPE COMPANY, INC.** GREAT NECK, N. Y.



*Division of the Sperry Corporation*

★  
LOS ANGELES • SAN FRANCISCO • SEATTLE • NEW ORLEANS  
CLEVELAND • BROOKLYN • HONOLULU

MAKERS OF PRECISION INSTRUMENTS FOR THE ARMED FORCES

# HICKOK

## Water Proof, Moisture Proof and Steam Proof METERS

Built in accordance with  
the War Standards Drawings

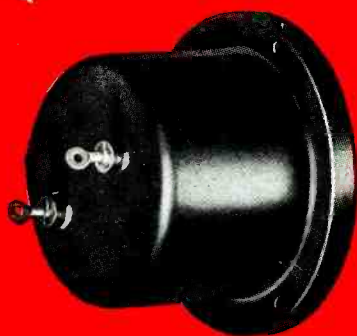

AVAILABLE IN  
2 1/2" — 3 1/2" — 4 1/4"  
ROUND STYLES  
INTERNAL PIVOT  
CONSTRUCTION

**VOLTMETERS... AMMETERS... MILLIAMMETERS...  
MICROAMMETERS... WATTMETERS... BOTH AC AND DC**

Now, you can get HICKOK precision and dependability in a new line of hermetically sealed meters. Available in 2 1/2", 3 1/2" and 4 1/4" round styles. Dimensions of American War Standards Assn. Drawings C39.2-1 and C39.2-2. The 4 1/4" size is built especially for use in radio service equipment where several scale arcs are required.

All instruments are hermetically sealed and both vacuum and pressure tested under water. Case fabricated of pressed steel and made corrosion resistant to meet specifications. Terminals are a special glass soldered-in type.

All meters are fully shielded, permitting use on either magnetic or non-magnetic panels. Operation is accurate and dependable even up to 85° centigrade. Internal pivot construction in D.C. types assures longer life and greater resistance to shock and vibration. Write for further information today.

**THE HICKOK ELECTRICAL INSTRUMENT CO.**  
10528 DUPONT AVENUE · CLEVELAND 8, OHIO

PRECISION CALIBRATED . . . LASTING ACCURACY

## FLYING FM-TELE

(Continued from page 234)

will result from Stratovision's high-altitude operation and the fact that its antennas will be in constant motion. This is in the matter of 'ghosting' the annoying out-of-register viewing which occurs when receivers pick up programs by two different waves—one arriving by the most direct path between the transmitter and the receiver, the other by a reflected path.

"Stratovision reduces the possibility of such reflection because its high-altitude operation will enable receiver owners to point antennas into the air—above mountains and other ordinary sources of ground reflection. In addition, movement of the plane will make any reflection which might occur of only very brief duration—so brief, perhaps, as to be undetected by the eye.

"Still another advantage of the plan—one of special interest to engineers concerned with television and FM relay systems—is the fact that Stratovision will drastically reduce distortion resulting from repeated amplification."

## FM-TELE STANDARDS

(Continued from page 95)

In the case of FM, the following Electrical Performance Standards of Transmitters and Associated Equipment have been set forth:

- (1) Standard power ratings and operating power range of FM broadcast transmitters shall be in accordance with the following table:

Standard Power Rating	Operating Power Range
250 watts	250 watts or less
1 kw	250 watts— 1 kw
3 kw	1— 3 kw
10 kw	3— 10 kw
25 kw	10— 25 kw
50 kw	10— 50 kw
100 kw	50—100 kw

In case any manufacturer decides to produce a 100 kw rating or any power rating not listed above, he must give notice to the Commission, which will release by Public Notice the manufacturer's name and the standard power rating of the transmitter to be produced at least six months prior to the delivery date or completion of such transmitter.

The operating power of any transmitter not listed above shall be from one-third standard to standard power rating.

Composite transmitters may be authorized with a power rating different from the above table, provided full data is supplied in the application concerning the basis employed in establishing the rating and the need therefor. The operating range of such transmitters shall also be from one-third of the power rating to the power rating.

The transmitter shall operate satisfactorily in the operating power range with a frequency swing of  $\pm 75$  kilocycles, which is considered as 100 per cent modulation.

- (2) The transmitting system shall be capable of transmitting a band of frequencies from 50 to 15,000 cycles. Pre-

(Continued on page 242)



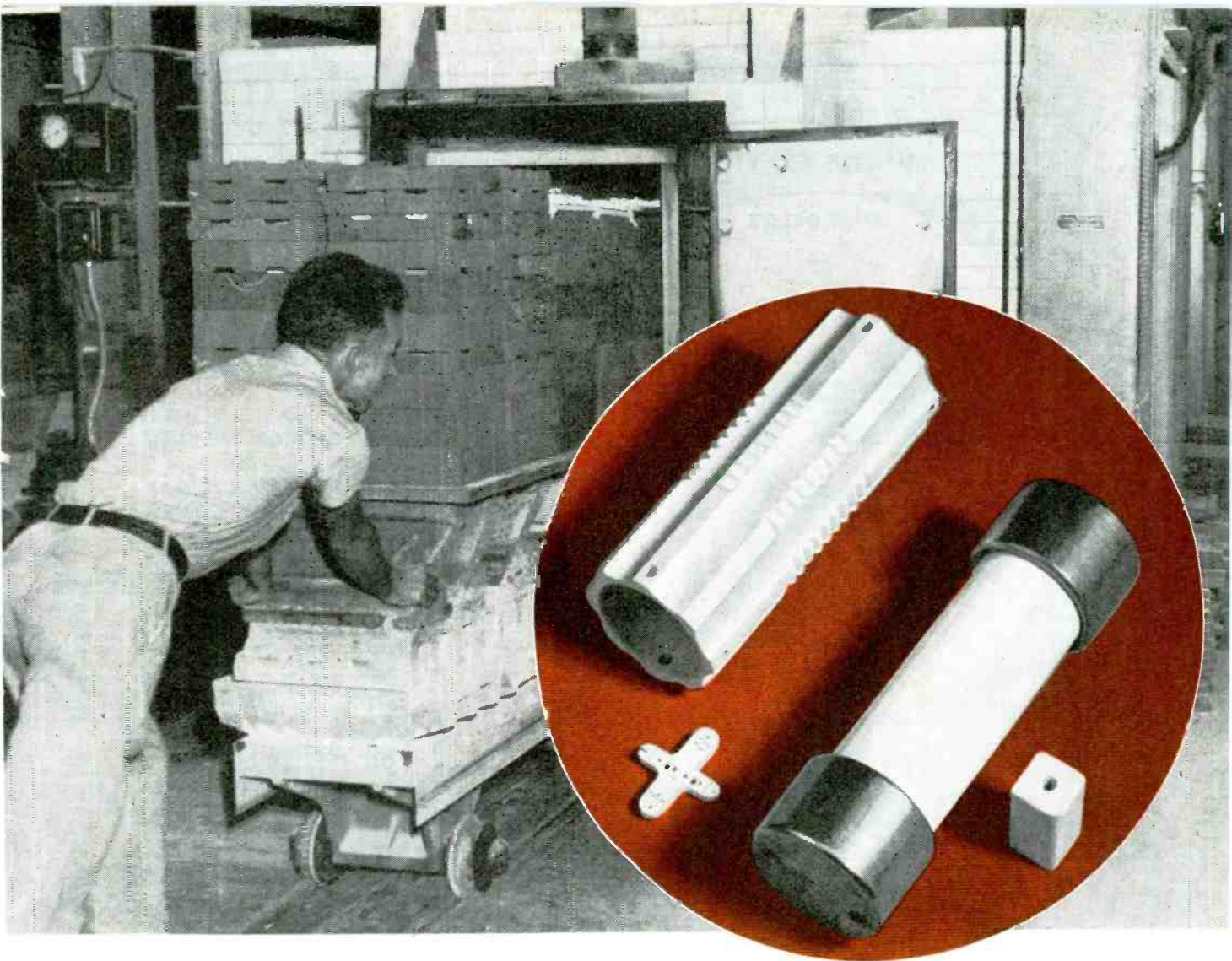

## BORN AT 2500°F.

ALSiMAG is master of power and heat because it takes its final, strong, hard, *rigid* form in furnaces at the white heat of 2500°F.

This inorganic material cannot char. It withstands red heat temperatures of 1800°F. ALSiMAG is highly resistant to thermal and electrical shock.

ALSiMAG insulators do not distort with loading nor cold-flow with time. They are non-corrodible.

Uniformity and dimensional accuracy of ALSiMAG Insulators facilitate assembly. Whatever you are planning in the electronic or electrical field—specify ALSiMAG for long-lived, dependable performance. Our Engineering and Research men are anxious to work with you. Literature applicable to the various fields of ALSiMAG uses, available on request.

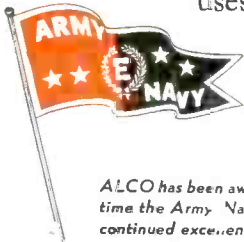

**AMERICAN LAVA CORPORATION**  
**CHATTANOOGA 5, TENNESSEE**

*ALCO has been awarded for the fifth time the Army-Navy "E" Award for continued excellence in quantity and quality of essential war production.*

**ALSiMAG**  
TRADE MARK REGISTERED U.S. PATENT OFFICE  
**STEATITE CERAMICS**

# AGASTAT

ELECTRO-PNEUMATIC RELAY

TIME DELAY

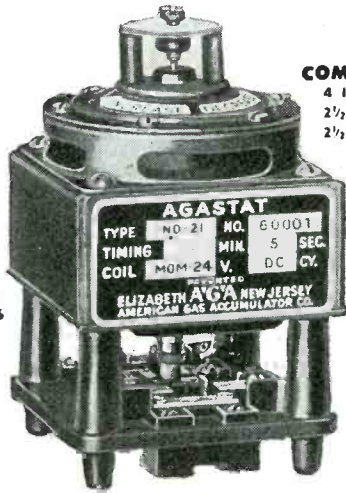

**COMPACT:**  
4 IN HIGH  
2 1/2 IN DEEP  
2 1/2 IN WIDE

**WEIGHT:**  
1 1/2 POUNDS

**AGASTAT**  
TYPE NO 21 HQ. 60001  
TIMING MIN. 5 SEC.  
COIL MOM. 24 V. DC CY.  
ELIZABETH A'G'A NEW JERSEY  
AMERICAN GAS ACCUMULATOR CO.

ELIZABETH A'G'A NEW JERSEY  
AMERICAN GAS ACCUMULATOR COMPANY

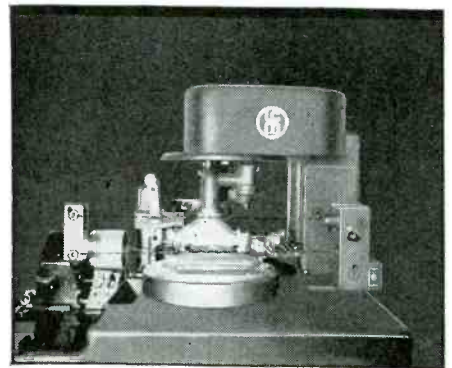

HOW  
ELECTRONIC CONTROLS  
PROTECT WORKERS  
ON  
INTERNATIONAL CIGAR  
MACHINERY COMPANY'S  
ROLLING MACHINES

Pictured equipment of The International Cigar Machinery Company cuts the cigar leaf wrapper. The process involving the hand operation of placing the wrapper leaf on the die on top of the turret shown in the center involves a hazard to the operator against which she is completely protected by the Photo-electric Safety Control.

Its operation (shown diagrammatically) is simple and effective. The area in which hands are in danger is covered by two protective beams of light originating at (A) passing to (B) where it is reflected from an angled mirror to a similar mirror at (C) which in turn reflects it to the photo-electric cell (D). Any interruption of either of these beams automatically stops the machine and protects the hand from the pressure cutter rollers (E) moving across the die and from other moving parts. The interruption of the beam is also indicated by a monitor light at (G). The machine cannot run while the light beams are interrupted and remains at rest even after removal of the obstruction, till the operator presses reset button (F).

In addition to removal of accident hazards and attendant benefits, plants which now use this safety equipment report that the sense of security engendered in the operator has consistently stepped up production.

OTHER APPLICATIONS of United Cinephone Electronic Controls are almost without limit. If you have a problem of measuring, gauging, counting, sorting, heating, or some other operation in your plant, which is costly and unreliable, you will want to investigate the possibility of solving the problem ELECTRONICALLY. That's where our extensive experience and facilities in Electronic design, engineering, and manufacturing can be of invaluable help. Your inquiry will be welcome.

Electronic fields we cover include:

1. Industrial Controls
2. Aircraft Communications
3. Laboratory Test Equipment
4. Radio and Audio Equipment

**UNITED CINEPHONE CORPORATION**

28 NEW LITCHFIELD STREET  
TORRINGTON, CONNECTICUT

DIALCO FOR POST-WAR PILOT LIGHTS

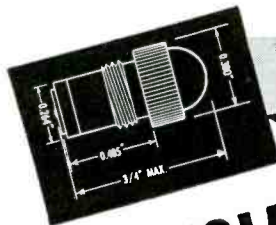

from "Midget" to "GIANT" ... the extensive line of  
**DIALCO PILOT LIGHT ASSEMBLIES**  
cover all physical and electrical requirements

From space-saving midget Pilot Lights to giant Marine Panel Assemblies, Dialco units offer unlimited variations in size, shape, functional design, and electrical characteristics. Fixed or variable intensity of light; smooth, faceted, or torpeda-type jewels; wide choice of colors and platings; Mazda or Neon Lamps—countless combinations of these factors are readily available for the production of Pilot Lights for Aircraft, Marine, Electrical, Electronic, Radio, and Industrial Apparatus. Samples from our standard line are available upon request. If your problem is unusual, our Engineering Dept. stands ready to design a Pilot Light to meet your particular requirements. For immediate assistance, write us about your needs today.

**PLUS LAMPS.**

To help speed production, we offer Pilot Lights complete with the required General Electric or Westinghouse Lamps

WRITE FOR CATALOGUE

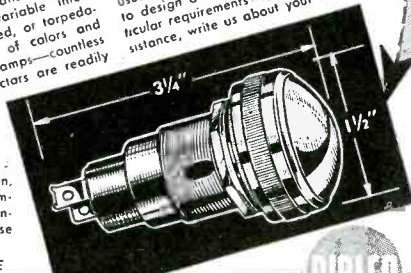

**DIAL LIGHT CO.** of America, Inc.

900 BROADWAY • NEW YORK 3, N. Y.  
Telephone: ALgonquin 4-5180-1-2-3

DIALCO FOR POST-WAR PILOT LIGHTS

# WHEN AMERICA TURNS TO POSTWAR PRODUCTS

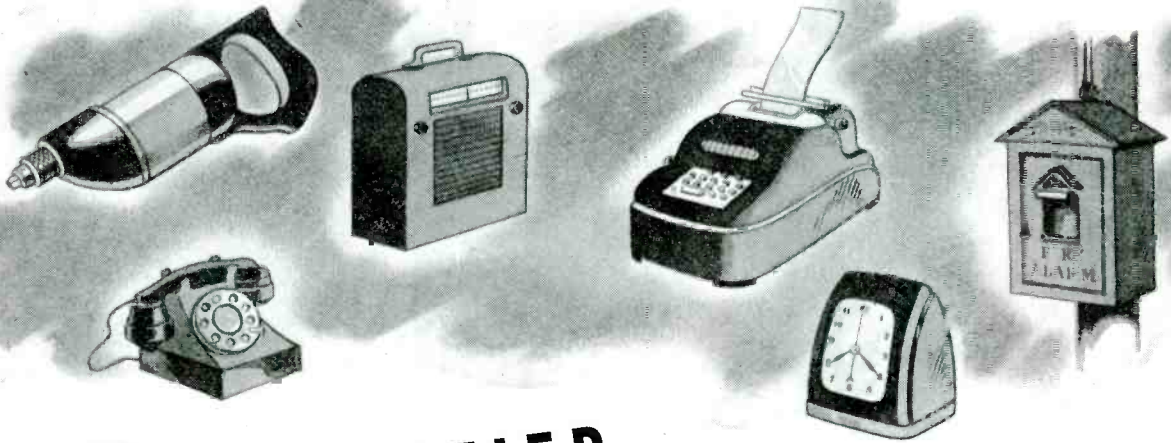

## A RECTIFIER MAY MEAN THE DIFFERENCE...

... Success or failure of many postwar products will depend on the correct selection of a d-c power unit. For most low-voltage d-c applications a copper-oxide, a selenium or a Tungar rectifier are the units most frequently used. G.E. and only G.E. builds all three. Each performs best when doing the job for which it was specifically designed.

When selecting a rectifier, construction, basic materials, weight, size, cost and life expectancy are all factors that must be considered. The conditions under which a rectifier is to operate and the results that are to be obtained determine which type will do the most economical, most efficient and most satisfactory job.

If you are in the market for a rectifier, choose the correct size and type from the G-E line. There's a size and type for every d-c application. If you need help in making your selection, let G-E engineers assist you. Years of experience qualify them to recommend the rectifier which will give you the most profitable performance. Whether they recommend copper-oxide, selenium or Tungar you can be sure their selection is impartial.

For more information write to Section A955-124, Appliance and Merchandise Department, General Electric Co., Bridgeport, Conn.

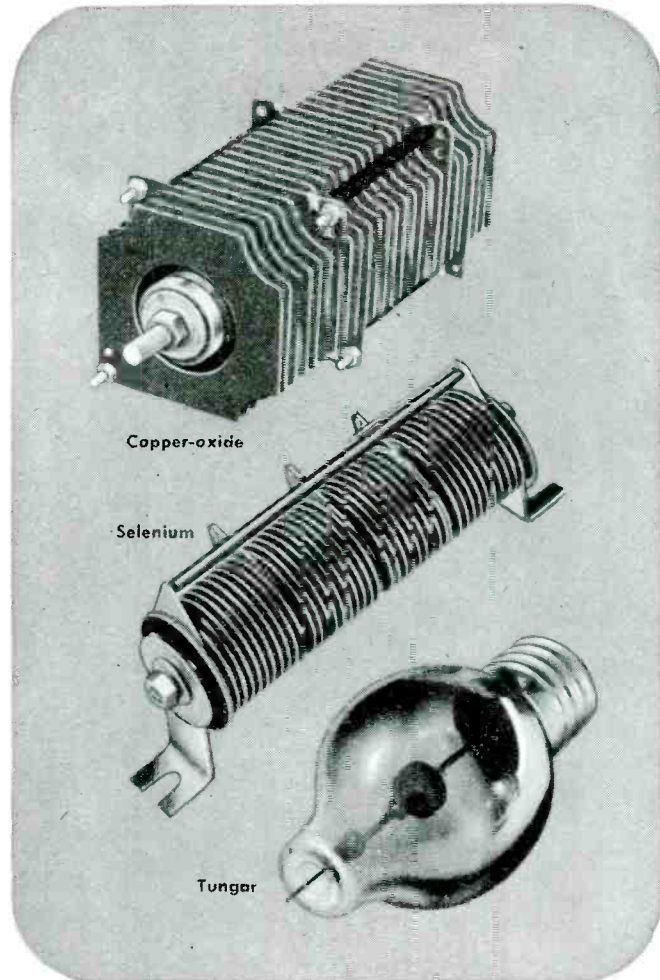

Copper-oxide

Selenium

Tungar

# GENERAL ELECTRIC

Hear the General Electric radio programs: "The G-E All Girl Orchestra" Sunday 10 P.M. EWT, NBC. "The World Today" news every weekday 6:45 P.M. EWT, CBS. "The G-E House Party" Monday through Friday 4:00 P.M. EWT, CBS.

BUY WAR BONDS AND KEEP THEM

# DESIGN COUNTS



**COMPARE** a modern sewing machine with the old-time model shown here. The difference is an example of how careful attention to design brings about a high level of efficiency.

Realizing this, design is one of the most carefully considered factors in the production of antennas at THE WARD PRODUCTS CORPORATION. It is only through superior design that the benefits of experience and the finest production facilities can be best brought to the user.

For the finest antennas for all applications... for home and automobile use... look to WARD.

# WARD

*Antennas*  
 BUY WAR BONDS  
 THE WARD PRODUCTS CORPORATION  
 1523 EAST 45TH STREET • CLEVELAND 3, OHIO

Export Dept. C. O. BRANDES, Mgr.  
 4900 Euclid Avenue  
 Cleveland 3, Ohio  
 Canadian Office ATLAS RADIO CORP.  
 560 King Street, W.  
 Toronto 1, Ont., Can.

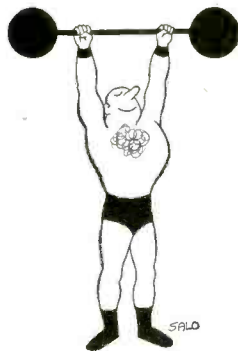
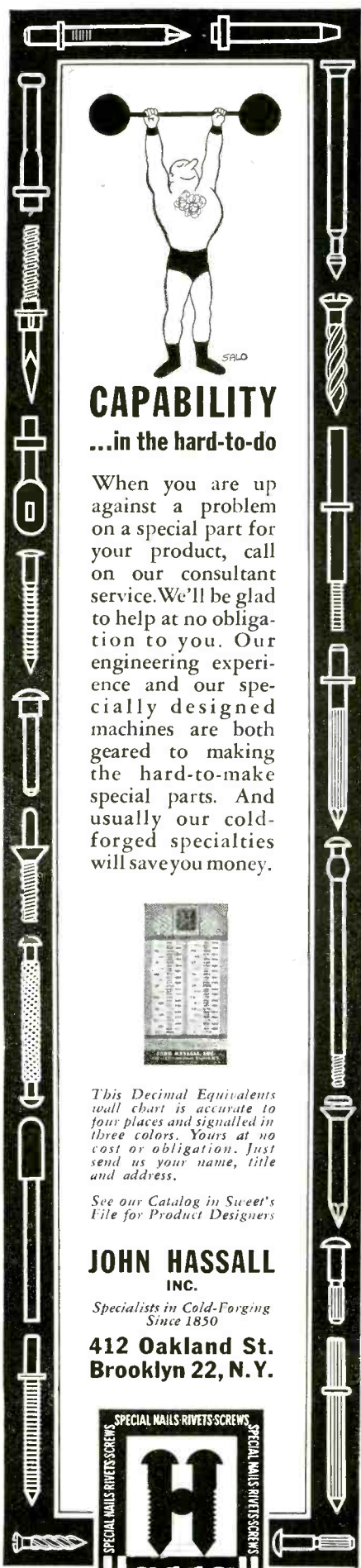

## CAPABILITY ...in the hard-to-do

When you are up against a problem on a special part for your product, call on our consultant service. We'll be glad to help at no obligation to you. Our engineering experience and our specially designed machines are both geared to making the hard-to-make special parts. And usually our cold-forged specialties will save you money.



*This Decimal Equivalents wall chart is accurate to four places and signalled in three colors. Yours at no cost or obligation. Just send us your name, title and address.*

*See our Catalog in Sweet's File for Product Designers*

## JOHN HASSALL INC.

*Specialists in Cold-Forging Since 1850*

**412 Oakland St.  
 Brooklyn 22, N. Y.**



## FM-TELE STANDARDS

(Continued from page 238)

emphasis shall be employed in accordance with the impedance-frequency characteristic of a series inductance-resistance network having a time constant of 75 microseconds. The deviation of the system response from the standard pre-emphasis curve shall lie between two limits. The upper of these limits shall be uniform (no deviation) from 50 to 15,000 cycles. The lower limit shall be uniform from 100 to 7,500 cycles, and three db below the upper limit; from 100 to 50 cycles the lower limit shall fall from the three db limit at a uniform rate of one db per octave (four db at 50 cycles); from 7,500 to 15,000 cycles the lower limit shall fall from the three db limit at a uniform rate of two db per octave (five db at 15,000 cycles).

- (3) At any modulating frequency between 50 and 15,000 cycles and at modulation percentages of 25 per cent, 50 per cent and 100 per cent, the combined audio frequency harmonics measured in the output of the system shall not exceed the root-mean-square values given in the following table:

Modulating Frequency	Distortion
50 to 100 cycles	3.5%
100 to 7,500 cycles	2.5%
7,500 to 15,000 cycles	3.0%

Measurements shall be made employing 75 microsecond de-emphasis in the measuring equipment and 75 microsecond pre-emphasis in the transmitting equipment, and without compression if a compression amplifier is employed. Harmonics shall be included to 30 kc.

It is recommended that none of the three main divisions of the system (transmitter, studio to transmitter circuit, and audio facilities) contribute over one-half of these percentages since at some frequencies the total distortion may become the arithmetic sum of the distortions of the divisions.

- (4) The transmitter output noise level (frequency modulation) in the band of 50 to 15,000 cycles shall be at least 60 decibels below the audio frequency level representing a frequency swing of  $\pm 75$  kilocycles.
- (5) The transmitter output noise level (amplitude modulation) in the band of 50 to 15,000 cycles shall be at least 50 decibels below the level representing 100 per cent amplitude modulation.
- (6) Automatic means shall be provided in the transmitter to maintain the assigned frequency within the allowable tolerance (2,000 cycles).
- (7) The transmitter shall be equipped with suitable indicating instruments for the determination of operating power and with other instruments as are necessary for proper adjustment, operation, and maintenance of the equipment.
- (8) Adequate provision shall be made for varying the transmitter output power to compensate for excessive variations in line voltage or for other factors affecting the output power.
- (9) Adequate provision shall be provided in all component parts to avoid overheating at the rated maximum output power.
- (10) Means should be provided for connection and continuous operation of approved frequency and modulation monitors.
- (11) If a limiting or compression amplifier is employed, precaution should be maintained in its use and connection in the circuit due to the use of pre-emphasis in the transmitter.

# England Calling!



## AMERICA ANSWERED WITH AIRPLANES... AND COMPLETE RADIO EQUIPMENT

The American aircraft industry knows what Englishmen meant when they said *so many owe so much to so few*. For it was our aircraft industry that squeezed out every available plane to add to their own so that England could fight . . . and win the Battle of Britain in 1940.

We at Pacific Division are proud to have contributed—not with radio equipment alone—but by designing and supervising the entire radio installation in each of the many models of American planes.

This was the first time such a job had been done . . . and it had to be done in a hurry. We designed complete interphone systems, antennas and filters, and engineered each into a network of controls . . . that played their part in the spectacular victory of the R. A. F.

Soon Pacific Division will announce a new line of peacetime VHF Communication Systems for industry which we have been perfecting over the past three years. Our experience and research, which have resulted in these developments, are at your disposal to make the greatest possible use of them for your own application. Information and engineering assistance are available to you NOW without obligation.

© 1945, Bendix Aviation Corp.



*Pacific Division*

Bendix Aviation Corporation

11619 Sherman Way, North Hollywood, California

LINCOLN BLDG.  
NEW YORK 17
CONTINENTAL BLDG.  
ST. LOUIS 8

COMMUNICATION SYSTEMS

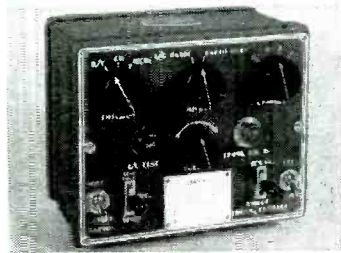

This control unit was one of many pieces of equipment built for intercommunication in British airplanes.

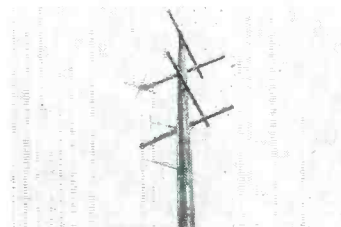

To determine most efficient antenna for VHF communication Pacific Division is testing numerous types.

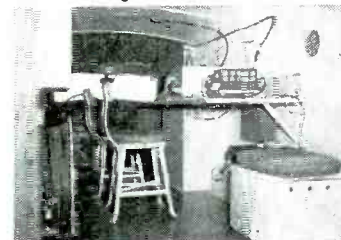

Interior of Pacific Division's mobile laboratory used in VHF communication development program.

# NORTON **N** INSTRUMENTS

## PORTABLE AMMETERS-VOLTMETERS



Reliable, sturdy, portable Ammeters and Voltmeters for testing purposes. These instruments are built to maintain accuracy under hard usage in electronic, marine, and industrial service, power plants and electrical repair work.

Hand calibrated, hand drawn dials assure accuracy at every part of the scale. Supplied with knife-edge pointer and mirror reflector for quick, accurate reading.

*Send for latest Catalog*

**NORTON Electrical Instrument Co.**  
85 HILLIARD ST., MANCHESTER, CONNECTICUT

## AIRCO GAS PROPORTIONER

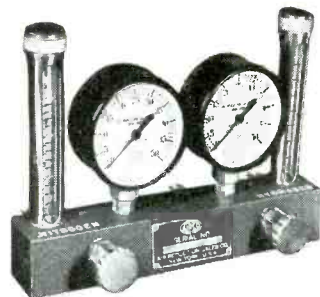

## CONVENIENT—ACCURATE GAS MIXING DEVICE

Designed to meet the needs of electronic tube manufacturers using gas mixtures for protective atmospheres, this new Airco development produces an accurately proportioned mixture at a pressure not in excess of 5 psi. A complete line of flowmeters is available to permit flows of hydrogen from about 2 to 200 cfh. and of nitrogen from about 6 to 140 cfh.

For full details, write today for a descriptive folder (ADI-892). Address:

## AIR REDUCTION

60 East 42nd Street  
New York 17, N. Y.



OFFICES IN  
PRINCIPAL CITIES

In Texas: Magnolia Airco Gas Products Company



# DUMONT CAPACITORS

FOR DEPENDABLE RADIO REPAIRS

SOLD ONLY THROUGH  
EXCLUSIVE JOBBER  
TERRITORIES

**DUMONT ELECTRIC CO.**

34 HUBERT ST. NEW YORK, N. Y.

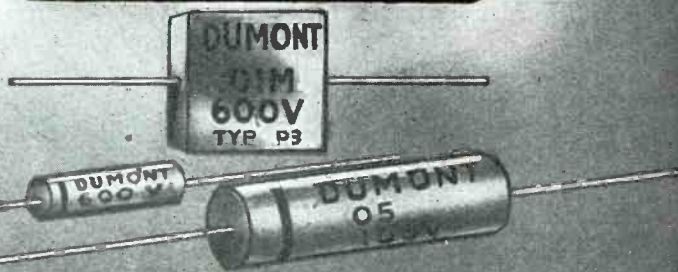

**NOTICE:** Sales Representatives, Some Territories Open.

# BIRD & CO. GLASS INSTRUMENT BEARINGS

GLASS "V" BEARINGS  
*made to your specifications*



*We welcome your inquiries*

## RICHARD H. BIRD

*Manufacturers of Jewel Bearings  
for thirty years*

23 MOODY STREET  
WALTHAM, MASS.

# Oil cooled POWERSTATS



*Increased Rating*

The "factory built" Oil-Cooled POWERSTAT Variable Transformers pioneered by SUPERIOR ELECTRIC COMPANY fulfill the demand for a variable transformer having the following features . . .

● HIGH CONTINUOUS RATING: Oil-Cooled POWERSTAT Variable Transformers are designed to operate continuously at currents which are double the air-cooled current rating.

● HIGH MOMENTARY OVERLOAD CAPACITY: Cooling oil in all parts of the POWERSTAT permits high current overloads of short duration to be applied to the unit.

● INCREASED VOLTAGE TO GROUND: POWERSTATS can be safely used at higher potentials to ground because of the high dielectric strength of transformer oil.

● SAFETY IN HAZARDOUS LOCATIONS: All connections are submerged under oil so the Oil-Cooled POWERSTATS may be safely used in explosive atmospheres.

● SCIENTIFICALLY DESIGNED CONTAINERS: The Oil-Cooled POWERSTATS are scientifically designed with optimum radiating area, adequate oil circulation and high conductivity tanks.

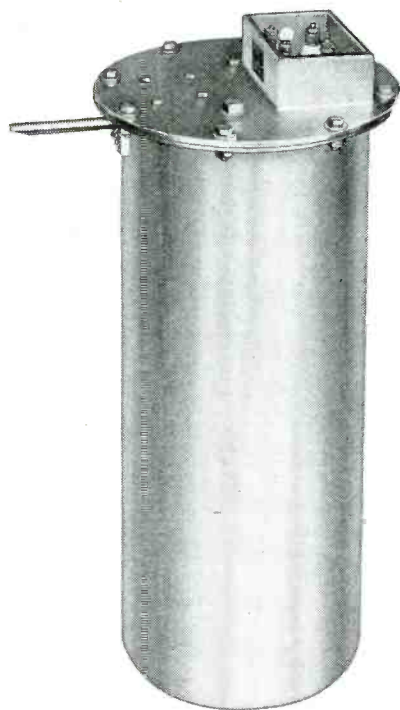

*Send for Bulletin IE*

**SUPERIOR ELECTRIC COMPANY**  
**469 LAUREL STREET** • **BRISTOL, CONNECTICUT**

# Specialized SWITCHING APPARATUS FOR ELECTRONIC EQUIPMENT

Shown below are just a few of many specialized types of switching apparatus which we design and manufacture specifically for electronic application. If you are confronted with an unusually difficult switching problem, write, and we'll be glad to consult with you regarding your requirements.

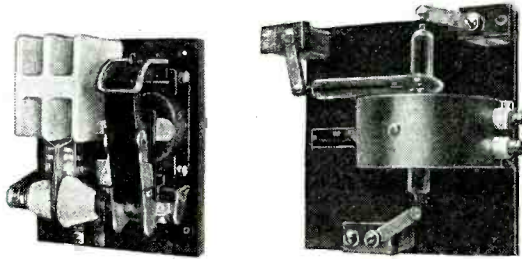

**HIGH VOLTAGE D. C. HOT BREAK CONTACTORS** for energizing high voltage vacuum tube circuits. Contactor, *above left*, breaks circuit carrying 1 ampere at 3,000 volts D. C. Contactor, *above right*, successfully breaks circuit carrying 2 amperes at 5,000 volts because contacts operate in a vacuum. This contactor incorporates principles of Eimac VS<sub>2</sub> vacuum switch which eliminates external moving parts. Operating coil completely shielded. Can be completely tropicalized.

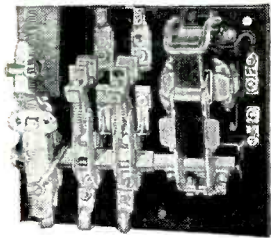

**CONTACTOR-TIMERS** used as main power or filament contactors with auxiliary delayed time circuit or circuits. Contactor and timer joined together physically, as well as electrically, saving space, assuring certain operation.

**HIGH VOLTAGE-HIGH FREQUENCY CONTACTORS** designed primarily for high frequency switching from a remote control point. Can be used with any high voltage cold break application—A. C. or D. C. All insulation of low loss type, either steatite or glass bonded mica. Held either mechanically or magnetically. Furnished either normally open, normally closed or both. Our complete line of contactors range from 15 amps at 3,000 volt minimum to 35 amps at 25,000 volt maximum.

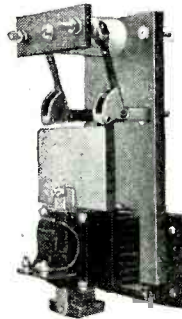

**HIGH FREQUENCY-HIGH VOLTAGE TRANSFER SWITCHES** for either radio or industrial load transfer. Magnetically operated from remote point but mechanically held in either position. Can accommodate currents up to 75 amps high frequency. Insulation of low loss type, either steatite or glass bonded mica. Cold break only.

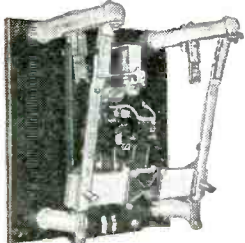

**COMBINATION POWER AND SIMULTANEOUS CONDENSER DISCHARGE CONTACTOR**, right, is a striking example of Monitor's ability to create highly specialized switching apparatus designed in accordance with unusual customer specifications.

Consult us on all of your switching requirements. Remember, we specialize in doing the unusual.

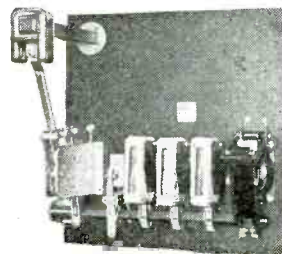

## NEW BULLETINS

### Wired Television

A new 16-page publication titled "Intra-Tel Systems," a commercial development of television, has been prepared by the Transmitter Division of the General Electric Co., Schenectady. The brochure describes in detail a television system for use by department stores, and gives the initial cost and yearly operating expense based on prewar prices for a typical system. It is illustrated by charts, drawings, and scenes from recent merchandising presentations over GE's television station WRGB.

### Science of Measurement

This is a study course in tool inspection and instrumentation, published by the Continental Machines, Inc., 1301 Washington Avenue South, Minneapolis (4), Minn., manufacturers of DoALL products. This course, comprising eight booklets, was produced by the DoALL Trade School, DesPlaines, Ill., to aid machinists in becoming production inspectors and tool inspectors and becoming adept in the type of instrumentation that makes precision possible.

Volume I entitled "Progress in Precision" makes up the basic principles of gage blocks and outlines some of the methods whereby extremely precise measurements can be carried out. This booklet also contains a glossary of terms and a set of questions and answers on that part of the problem.

Booklet II is devoted to the inspection and care of gage blocks. Booklet III describes the uses of these blocks and outlines typical problems where they are used. Booklet IV outlines other accessories of precision, including surface plates, master flats. Booklet V explains the sine bar and its uses in the measurement of angles, bevels and tapers. Booklet VI is devoted to the measurement to a millionth of an inch using optical flats and measurements in terms of light wavelength. Booklet VII is devoted to the DoALL Comparator for threads and gears. The last booklet of the series describes the setting up of a mobile inspection unit and the establishment of inspection procedures associated with the manufacture of some product.

Each of these booklets is quite complete and provides a standard reference series for schools or industrial training courses and should be of interest to any one seeking detailed information on precision measuring methods. Each booklet contains many illustrations, photographs, tables and tool design information. This course is available to schools and to industrial training programs.



**The Monitor  
Controller Company**  
BALTIMORE 2, MARYLAND



CANADIAN AFFILIATE • CANADIAN CONTROLLERS LTD. • TORONTO, ONTARIO, CANADA



# Have you looked into METALLIZED GLASS?

**Y**OUR electronic problems may find an answer in Corning's process for permanently bonding metal to glass.

Which of the following qualities will help you?

1. **Hermetic bond** between glass and metal — assures positive and permanent seal against oil, water, and gas.
2. **Precision metallizing** — allows accurate control of capacitance, inductance, or resistance.
3. **Permanent mechanical and electrical qualities** — maintain accurate tolerances indefinitely.
4. **Superior electrical properties** of glass — low power factor, high dielectric strength, extremely high resistance, wide range of dielectric constants.
5. **Thermal endurance** of a high order. Metallized glass easily meets Army and Navy specifications for thermal shock.

• • •

*Write us about your problems. We'd be interested in seeing if glass can help you. Address Electronic Sales Dept. 1-9, Corning Glass Works, Corning, N. Y.*

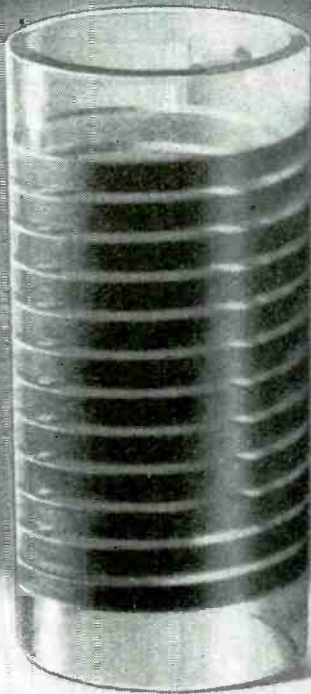

**CORNING**  
— means —  
Research in Glass

## Electronic Glassware



"PYREX" and "CORNING" are registered trade-marks of Corning Glass Works

**NEED SMALL, INTRICATE  
METAL STAMPINGS  
TO CLOSE TOLERANCES?**

**GOAT** *Precise-Formed*  
**METAL STAMPINGS**

**HOW GOAT SAVES YOU  
TIME AND MONEY**

Goat specializes in the design and fabrication to close tolerances of small, intricate, drawn, formed, stamped metal and alloy parts. Expert tool design, quality control, and modern manufacturing techniques can save you time and money on parts like those illustrated above.

ENGINEERS  
SEND US  
YOUR  
PROBLEMS



**GOAT** METAL STAMPINGS, INC.

AN AFFILIATE OF THE FRED GOAT CO., INC.  
314 DEAN STREET, BROOKLYN 17, N. Y.

**Hard to Get?  
HARRISON has it!**

Harrison usually has FOR IMMEDIATE DELIVERY, appropriate stocks of critical Electronic Parts and Equipment

**HALLICRAFTERS RECEIVERS**



Model SX-28A  
550 Kc to 42 Mc  
Fifteen Tubes  
**\$223**  
PM-23 Speaker  
**\$15**

**RESISTORS**

1,493,000 In Stock!  
.1 OHM to 22 Megohm  
1/4 watt to 600 watts  
FIXED—ADJUSTABLE—  
CONTROLS—  
VARIABLE—  
WIREWOUND—  
COMPOSITION—  
PRECISION—

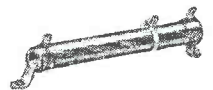

Have YOU a copy of our  
NEW MASTERS BUYERS GUIDE?

**HARRISON**  
RADIO CORPORATION

12 WEST BROADWAY • NEW YORK CITY 7  
BARCLAY 7-9854  
JAMAICA BRANCH — 172-31 Hillside Ave. — REpublic 9-4102

*Laboratory  
Standards*



**PULSE GENERATOR**

**MODEL 79-B**

**SPECIFICATIONS:**

**FREQUENCY:** continuously variable 60 to 100,000 cycles.

**PULSE WIDTH:** continuously variable 0.5 to 40 microseconds.

**OUTPUT VOLTAGE:** Approximately 150 volts positive.

**OUTPUT IMPEDANCE:** 6Y6G cathode follower with 1000 ohm load.

**R. F. MODULATOR:** Built-in carrier modulator applies pulse modulation to any r.f. carrier below 100 mc.

**MISCELLANEOUS:** Displaced sync output, individually calibrated frequency and pulse width dials, 117 volt, 40-60 cycles operation, size 14"x10"x10", wt. 31 lbs.

Price: \$295.00 F.O.B. BOONTON

Immediate Delivery

**MEASUREMENTS CORPORATION**

BOONTON • NEW JERSEY

**ATTENTION:**

Commercial Broadcasters

Schools

Hospitals

Utility Companies

Geophysicals

Transportation Companies

Marine Operators

Industrial Plants

Municipalities

Radio Dealers

Radio Servicemen

**AT EASE!**

Everything in radio and electronics from a 1/4 watt resistor to 50,000 watt transmitter (post-war).

Engineering Assistance, too.

Call—Wire—Write.

**Houston Radio Supply Co., Inc.**

910 CALHOUN STREET

HOUSTON, TEXAS

'Ole Miss Supply Baton Rouge, La.

# ENGINEERS

FOR DESIGN WORK  
ON RADIO RECEIVERS,  
AUDIO AMPLIFIERS,  
TELEVISION

Men with substantial experience wanted, preferably those having Degrees in Electrical or Communications Engineering. Write, giving details of experience and salary expected, to:

## FREED RADIO CORPORATION

Makers of the Famous Freed-Eisemann Radio-Phonograph

200 HUDSON STREET  
NEW YORK 13, N. Y.

## SPECIALIZED TRANSFORMERS FOR ALL APPLICATIONS

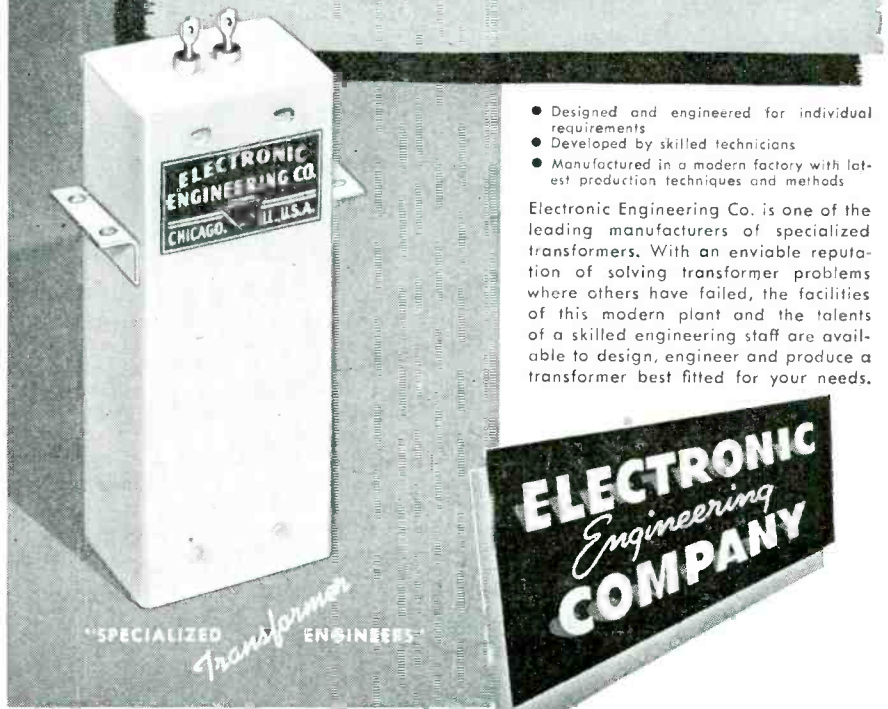

- Designed and engineered for individual requirements
- Developed by skilled technicians
- Manufactured in a modern factory with latest production techniques and methods

Electronic Engineering Co. is one of the leading manufacturers of specialized transformers. With an enviable reputation of solving transformer problems where others have failed, the facilities of this modern plant and the talents of a skilled engineering staff are available to design, engineer and produce a transformer best fitted for your needs.

3225 WEST ARMITAGE AVENUE CHICAGO 47, ILLINOIS

## CONNECT 2 to 12 WIRES

**BURKE** Terminal blocks provide for the centralized connection of numerous wires at one point of control. Sizes are available to handle 2, 4, 6, 8, 10 and 12 wires in one block.

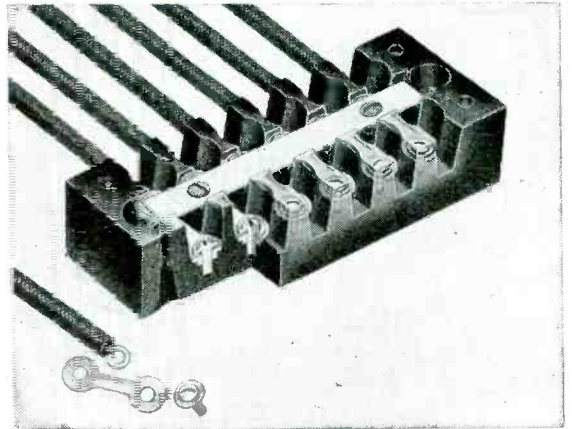

**SERIES 2000** is the heaviest design in the Burke Line—has heavy barriers and specially formed slot openings to secure free wire ends without the use of lugs—handles the small wires or stranded cable. Address: 1159 W. 12 St.

★ Write for New Booklet



AC AND DC MOTORS AND GENERATORS  
**BURKE Terminal BLOCKS**  
BURKE ELECTRIC COMPANY • ERIE, PENNSYLVANIA

**DKE** CAPS  
AND  
BASES

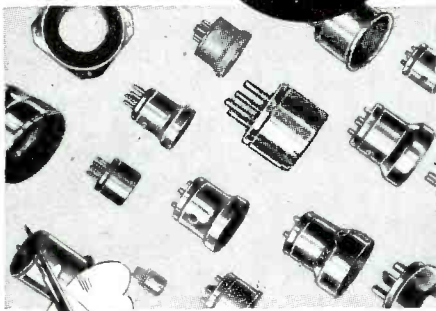

..for precision application!

Dependable DKE electronic tube components are used extensively by many of the leading manufacturers. A wide variety of standard designs are available, with exceptional economies resulting from complete DKE tooling facilities. Special bases, caps and clips can be produced to exacting specifications on short notice with low unit cost.

INQUIRIES INVITED

**THE ENGINEERING CO.**  
DANIEL KONDAKJIAN  
27 WRIGHT ST., NEWARK, N. J.

# HEXACON

is helping to do the job at *Bendix*



## HATCHET TYPE IRON . . for hard-to-get-at-work

The intricacies of modern instruments and apparatus stressed the need for a soldering iron of special design to meet unusual requirements. The HEXACON Hatcher type iron was designed for tedious, involved work embodying unusual soldering handicaps and inconveniences, and is now efficiently serving on the famous Bendix production line.

With performance and dependability comparable to all HEXACON quality soldering irons, the Hatcher type has the advantage, too, of "Balanced Heat" design. This exclusive HEXACON feature minimizes element burn-outs and excessive tip wear.

## HEXACON ELECTRIC CO.

157 WEST CLAY AVE., ROSELLE PARK, N. J.

Literature describing the diversified HEXACON line—from 40 to 700 watts, and with tip diameters ranging from 1/4" to 1 3/4" — sent on request.

HIGH-QUALITY  
LONG-LASTING  
SOLDERING IRONS

# HEXACON

## NEW BULLETINS

### Ignitron Features

A new twenty-four page publication (ETI-21) on the General Electric Co.'s ignitron tube, has been published by the Tube Division of the company, Schenectady. The booklet describes the operating characteristics and performance ratings of the G-E ignitron tube types with a full explanation of how they are used in welding circuits and for power rectification. The applications of the ignitron—in steel mills, mines, plane factories, floating drydocks and many other war-gearred industries—are outlined.

### Industrial Molding

Much valuable information on thermosetting and thermoplastic resin molding is contained in a booklet issued by Chicago Molded Products Corp., 1020 North Kolmar avenue, Chicago. Characteristics of various plastics are charted. Compression, transfer and injection molds are described, and numerous important considerations relating both to manufacturing difficulties and costs which affect the design of molds are explained in a step by step manner. Many illustrations add interest and clarity.

### Precision Finishing

A new 12-page booklet "Faster, Better Finishing of Metal, Plastic and Glass," describing the 3-M Wetordry method of precision grinding and finishing at high speeds, has just been released by the Minnesota Mining and Mfg. Co., St. Paul, Minn.

The booklet explains, in non-technical language, how this grinding and finishing method keeps operating heat at a minimum; eliminates distortion, discoloration and plastic flow; increases the life of abrasive belts; eliminates the hazard created by dust when grinding glass, ceramics and certain metals.

An outstanding feature of this new booklet are numerous illustrations showing actual industrial applications of the method to problems frequently encountered in grinding and finishing departments.

### Dial Light Sockets

The new Lenz catalog (No. 101) contains specifications and dimensions for 28 different standard mounting brackets that will answer practically every dial light mounting problem. Four different styles of dial light sockets are described and illustrated. Publisher is Lenz Electric Mfg. Co., 1751 N. Western avenue, Chicago.

**AMCON**

*Capacitors*

- SHOCK-PROOF
- BATTLE-TESTED
- DURABLE
- DEPENDABLE

American Capacitors meet the most exacting precision requirements because they are fabricated by experienced craftsmen. Electrolytic and Paper Capacitors, incorporating new plastic designs, covers all standard capacitance values and working voltages.

"There is an Amcon for every size and purpose"

**AMERICAN CONDENSER COMPANY**  
4410 RAVENSWOOD AVENUE • CHICAGO 40, ILLINOIS

# ENGINEERING WRITERS WANTED

- Graduate engineers with good practical knowledge of electrical or electronic applications.
- Individuals who like to express themselves in writing.
- Men with an ability to emphasize in their own thinking, as well as in that of others, those things which possess common denominators of interest.

Substantial postwar opportunities, with interesting work and broad contacts.

Write fully, detailing your training and experience, salary desired, etc.

Address Box 9516

## ELECTRONIC INDUSTRIES

480 Lexington Avenue

New York 17, N. Y.

# IMPORTANT RESISTOR DATA

These 12 pages of valuable resistor information are important to you! Here is complete data on Lectrohms wide selection of Vitreous Enameled Resistors; including fixed, adjustable, "Rib - on - edge" and ferrule terminal types—powerline and R. F. chokes, brackets, bushings, solder pots, etc., with illustrations and complete description. If you do not have a copy—write for it!



**LECTROHM**  
INCORPORATED

5139 West 25th Street, Cicero, Illinois

Division of the National Lock Washer Company,  
Newark, N. J.

## TO ENGINEERS and LABORATORY ASSISTANTS

Experienced in any of the following

**UHF, FREQUENCY MODULATION  
TELEVISION, or COMMUNICATION**

## RECEIVERS

We can offer a unique opportunity with unlimited possibilities in the fields of Laboratory and Production Testing, Navigation, Direction Finding and Communications.

Excellent working conditions with profit sharing and pension plan.

*Write or Call*

PERSONNEL DEPARTMENT  
**PANORAMIC RADIO CORPORATION**

242-250 West 55th Street  
New York 19, New York

# Kahle

**ENGINEERING COMPANY  
ELECTRON TUBE MACHINERY**

All types, standard and special design.

Specialists in equipment and methods for the manufacture of:

RADIO TUBES	NEON TUBES
CATHODE RAY TUBES	PHOTO CELLS
FLUORESCENT LAMPS	X-RAY TUBES
INCANDESCENT LAMPS	GLASS PRODUCTS

On Production or Laboratory basis

1307-1315 SEVENTH ST., NORTH BERGEN, N. J., U. S. A.

**WANTED**, for our postwar laboratory:

**DESIGNING DRAFTSMAN** with prewar experience in preparing production drawings of cabinets for home radios.

**CABINET BUYER**, experienced, for wooden cabinets. Pleasant working conditions in air conditioned office. Top salaries.

Call or see

**MR. C. N. EHRLICH**  
Chief Mechanical Engineer  
Hamilton Radio Corporation  
510 Sixth Ave. (near 14th St.), N. Y. C.  
GRamercy 7-5210



The Employees and Management  
of  
The Benwood-Linze Company  
and  
The B-L Electric Manufacturing Co.

are honored to announce  
that the  
Army-Navy "E" Production Award  
for

Excellence in War Production  
was made to the company on  
Thursday, August twenty-third  
Nineteen hundred and forty-five



## SELENIUM COPPER SULPHIDE

*A few B-L Rectifier applications are illustrated below:*



AUTO RADIOS

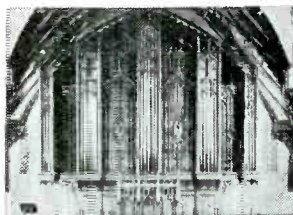

PIPE ORGANS

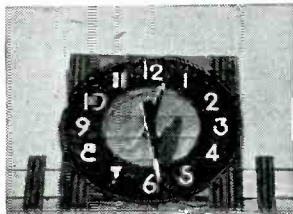

CLOCKS

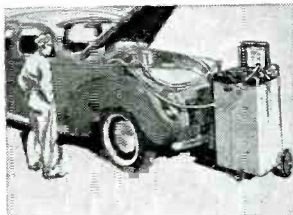

BATTERY CHARGERS



FIRE TRUCKS

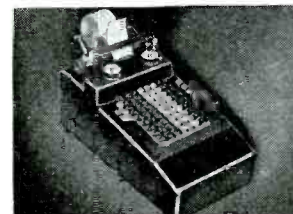

BUSINESS MACHINES

from AC →

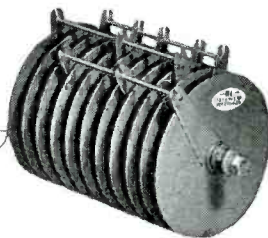

→ to DC

# B-L METALLIC ELECTRICAL RECTIFIERS (SELENIUM COPPER SULPHIDE)

### offer you these advantages:

#### They are COMPACT

For a given power output the space required by metallic rectifiers is very small.

#### They are SILENT

B-L Rectifiers are silent in operation and have no moving parts.

#### They are DEPENDABLE

Dependability is assured by their simple and rugged construction, in which no glass bulbs, filaments, or other fragile parts are employed.

#### They are TROUBLE-FREE

Regular maintenance and attention are unnecessary.

#### They are RUGGED

B-L Rectifiers are rugged and will withstand heavy overloads for short periods of time.

#### They are ADAPTABLE

B-L Rectifiers are adaptable for power outputs from Milliwatts to Kilowatts.

Many rectifier applications, heretofore considered impractical, have been devised by B-L Engineers. It is more than likely that they can be of assistance in solving your problems of converting AC current to DC... Write for Copper-Sulphide Bulletin R38-b — or for Selenium Bulletin R41-b.

### THE BENWOOD-LINZE COMPANY

1815 Locust Street . . . . . St. Louis 3, Mo.

Long Distance Telephone Central 5830

#### SALES OFFICES:

420 Lexington Ave. ☞ New York 17, N. Y. ☞ MUrray Hill 5-5878  
20 N. Wacker Drive ☞ Chicago 6, Illinois ☞ CENTral 2379

*Designers and Manufacturers of Selenium and Copper Sulphide Rectifiers, Battery Chargers, and DC Power Supplies for practically every requirement.*

## NEW BULLETINS

### Plastic Fabrication

Probably the one thing that manufacturers want most to know about plastics is whether such products can be used in any of their operations, and if so how it may be done and at what advantage. In an effort to put answers to such questions on paper, Kurzkasch, Inc., Dayton, Ohio, has issued an elaborate booklet which gives dozens of examples of how plastics now are being used. In addition, the booklet contains essential data in tabular form of a large number of plastics compounded for particular purposes, as well as considerable engineering data on molds and molding.

### Microphone Catalog

A new catalog of dynamic, velocity and carbon microphones has been issued by Electro-Voice Inc., South Bend 24, Indiana. The first few pages are devoted to a theoretical discussion of microphone characteristics. A useful nomographic chart is included for the conversion of various methods of rating the output of microphones to a common standard. A number of poly-directional as well as cardioid directional microphones are listed.

### Surplus Property

Approximately 3,000 items of Government-owned surplus property which the Reconstruction Finance Corporation handles as a disposal agency designated by the Surplus Property Board for capital and producers' goods are listed in a booklet, "How To Do Business With RFC," which has just been published by RFC. Copies of the booklet may be obtained from the RFC Agency, at 70 Pine Street, New York.

### Power Equipment

Carter Motor Co., 1608 Milwaukee avenue, Chicago, has issued a new and condensed bulletin No. 445 which shows the outstanding units of its line—genmotors, magmotors and other rotary equipment. A number of newly developed units are shown. Among these are improved permanent magnet fields on the magmotor generators and two models of self-powered hand generators.

### Electron Study

The Electronic Corp. of America, 45 W. 18th Street, New York, has published "The Amazing Electron" for distribution to educators, consumer organizations, farm groups, and labor unions, and the general public.

Profusely illustrated in cartoon technic, and simply written, the booklet is intended to bring within the grasp of everyone the basic facts about electronics.

### Job Manufacturing

A new booklet has been issued by the Alden Co., Brockton, Mass., describing the manner in which it is equipped to manufacture quickly on order. Emphasis is laid upon thorough planning and "project" type of organization to turn out special radio or mechanical products and assemblies.

### Large Tube Manual

A new technical reference manual on larger type tubes has been issued by United Electronics Co., 42 Spring St., Newark 2, N. J. Complete technical specifications and curves are given for each tube type manufactured. These comprise high vacuum tubes, high vacuum rectifiers, mercury vapor rectifiers, grid controlled rectifiers and cold cathode tubes. In addition there are chapters on the basic theory of electron tubes, manufacturing procedure, functions and modes of operation, circuit data and end use of electron tubes. Also included are standardization considerations, cross over charts, definitions, standard symbols and conversion tables.

## Long Scale, Wide Range Volt-Ohm-Milliammeter



#### DOUBLE SENSITIVITY D.C. VOLT RANGES

0-1.25-5-25-125-500-2500 Volts, at 20,000 ohms per volt for greater accuracy on Television and other high resistance D.C. circuits.

0-2.5-10-50-250-1000-5000 Volts, at 10,000 ohms per volt.

#### A.C. VOLT RANGES

0-2.5-10-50-250-1000-5000 Volts, at 10,000 ohms per volt.

#### OHM—MEGOHMS

0-400 ohms (60 ohms center scale)  
0-50,000 ohms (300 ohms center scale)

#### DIRECT READING OUTPUT LEVEL DECIBEL RANGES

—30 to +3, +15, +29, +43, +55, +69 DB

#### TEMPERATURE COMPENSATED CIRCUIT FOR ALL CURRENT RANGES D.C. MICRO-AMPERES

0-50 Microamperes, at 250 M.V.

#### D.C. MILLIAMPERES

0-1-10-100-1000 Milliamperes, at 250 M.V.

#### D.C. AMPERES

0-10 Amperes, at 250 M.V.

#### OUTPUT READINGS

Condenser in series with A.C. Volts for output readings.

#### ATTRACTIVE COMPACT CASE

Size: 2 1/2" x 5 1/2". A readily portable, completely insulated, black, molded case, with strap handle. A suitable black, leather carrying case (No. 629) also available, with strap handle.

#### LONG 5" SCALE ARC

For greater reading accuracy on the Triplet RED DOT Lifetime Guaranteed meter.

#### SIMPLIFIED SWITCHING CIRCUIT

Greater Ease in changing ranges.

Write for descriptive folder giving full technical details.

HERE'S THAT NEW  
**TRIPLET**  
**625-N**

# Triplet

ELECTRICAL INSTRUMENT CO. BLUFFTON, OHIO

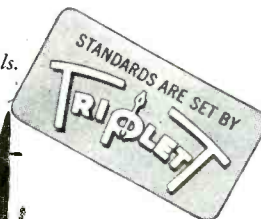



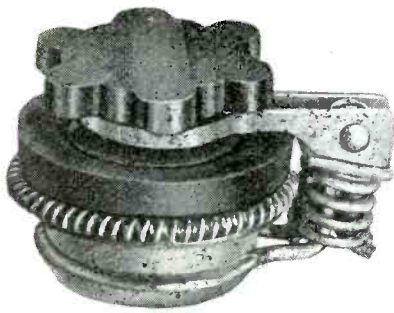

## Waterproof Jack Covers

enable jacks to be completely sealed against water and moisture. No special holes or tools required.

Specified on many Navy items. Knob available in black or red. All necessary hardware included. Moderately priced.

Send for catalog on this and other waterproofing items.

# WATERPROOF

ELECTRIC COMPANY

70 E. VERDUGO AVE., BURBANK, CALIF.

## MAGNETIC WIRE RECORDING

RESEARCH  
DEVELOPMENT  
MANUFACTURE

# WiRecorder Corporation

STROH BLDG.

DETROIT

MICHIGAN



## THERMOSTATIC METAL TYPE DELAY RELAYS

PROVIDE DELAYS RANGING  
FROM 1 TO 120 SECONDS

Other important features include:—

1. Compensated for ambient temperature changes from  $-40^{\circ}$  to  $110^{\circ}$ F.
2. Contact ratings up to 115V-10a AC.
3. Hermetically sealed — not affected by altitude, moisture or other climate changes . . . Explosion-proof.
4. Octal radio base for easy replacement.
5. Compact, light, rugged, inexpensive.
6. Circuits available: SPST Normally Open; SPST Normally Closed.

WHAT'S YOUR PROBLEM? Send for "Special Problem Sheet" and Descriptive Bulletin.

**AMPERITE CO.** 561 BROADWAY  
NEW YORK 12, N. Y.

In Canada: Atlas Radio Corp., Ltd.  
560 King St. W., Toronto

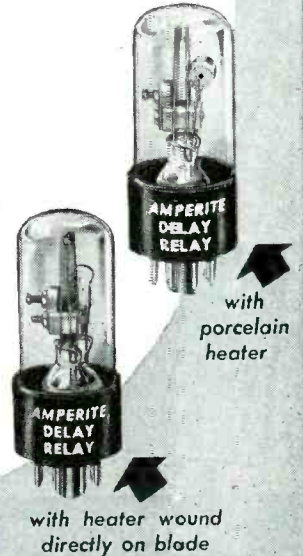

## FM SIGNAL GENERATOR

### TYPE 150-A series

Developed to assist engineers in designing FM equipment—RECEIVERS, TRANSMITTERS, AMPLIFIERS, LIMITERS AND COMPONENTS

- Type 150 A—Frequency 41-50 mc. and 1-10 mc.
  - Type 151 A—Frequency 30-40 mc. and 1-9 mc.
  - Type 152 A—Frequency 20-28 mc. and 0.05-5 mc.
  - Type 154 A—Frequency 27-39 mc. and 1-7 mc.
- Frequency and Amplitude Modulation available separately or simultaneously.



**BOONTON RADIO**  
Corporation

BOONTON, N. J.



DESIGNERS AND MANUFACTURERS OF THE "Q" METER . . . QX-CHECKER . . . FREQUENCY MODULATED SIGNAL GENERATOR . . . BEAT FREQUENCY GENERATOR . . . AND OTHER DIRECT READING TEST INSTRUMENTS

TWO BOOKS EVERY ENGINEER NEEDS

## THE CATHODE-RAY TUBE AT WORK by John F. Rider



In using the Cathode-Ray Tube to its fullest capabilities, it is necessary to understand its theory and functioning. This book explains the various types and what role each element plays.

More than half the book is devoted to the practical applications illustrated with oscillograms.

338 PAGES . 450 ILLUSTRATIONS . \$4.00

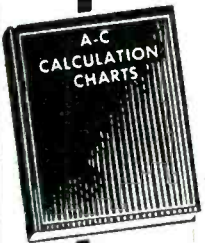

### A-C CALCULATION CHARTS

Faster than a slide rule. It covers all A-C calculations in series circuits, parallel circuits, series-parallel and mesh circuits, at frequencies from 10 cycles to 1000 megacycles. 146 Charts—7" x 11"—Two colors—\$7.50.

**JOHN F. RIDER PUBLISHER, INC.**

404 FOURTH AVENUE • NEW YORK 16, N. Y.

EXPORT DIV.: ROCKE-INTERNATIONAL CORP. 13 E. 40TH ST., NEW YORK

### Openings for

## RADIO ENGINEERS ELECTRICAL ENGINEERS MECHANICAL ENGINEERS

In the development and production of all types of radio receiving and low-power transmitting tubes. Excellent post-war opportunities with an established company in a field having unlimited post-war possibilities.

Apply in person or in writing to:

Personnel Manager

**RAYTHEON  
MANUFACTURING CO.**

Radio Receiving Tube Div.

55 CHAPEL ST., NEWTON, MASS.

### EXECUTIVE

Manufacturing corporation, international in scope, with a sales volume of approximately 40 million dollars a year, in radio, electrical business, can use the services of a top ranking executive officer, preferably a man under 40 with manufacturing and general executive experience. This is a fast growing young organization and can offer unparalleled opportunity to the right man, with a salary commensurate with his ability.

BOX 8516

**ELECTRONIC INDUSTRIES**

480 Lexington Avenue

New York 17, N. Y.

### TERMINALS

for

ELECTRIC WIRES

### SMALL METAL STAMPINGS

in accordance with your blueprints

### PRECISION PARTS

from Modern Equipment

### PATTON-MacGUYER CO.

17 VIRGINIA AVENUE

PROVIDENCE 5, R. I.

### RESALE PRODUCTS WANTED

For sale to jobbers, including automotive, oil, hardware and farm cooperatives, by well-rated corporation established 1903, staffed by personnel long experienced in radio and electrical merchandising. Basis, sales agency, or agency doing own billing and carrying accounts, or contract purchase. Can also prepare advertising. Territory, eastern seaboard, or national with west handled thru established affiliates.

### GENERAL PRODUCTS DIVISION

Attention—Julian A. Wesseler, Manager

Automatic Fire Protection Company  
Englewood, N. J.

## CHEMICAL PROBLEMS?

AUTOMATIC ANALYSIS INSTRUMENTS

PURITY CONTROL METHODS

COATING PROCESSES

ANTI-CORROSION

CONSULT:

### PROCESS & INSTRUMENTS

60 GREENPOINT AVENUE

BROOKLYN 22, N. Y.

# GRACOIL

"One Good Turn - or a Million"

## A NAME TO LOOK FOR on ELECTRICAL COILS and TRANSFORMERS



LAYER-WOUND COIL



LOW VOLTAGE TRANSFORMER



GENERATOR FIELD COIL



RELAY COIL

Famous for years as  
"COILS by DOYLE"

★ "GRACOIL" is a new name that you can depend upon, because back of this name stand years of time-tested experience in electrical engineering. The same able craftsmen who established Doyle Coils as leaders in the field now carry on at the same location under the new corporate name—The GRAMER Company.

Be sure that the coil you buy bears the trademark name—"GRACOIL", for only then can you know that you have the best in electro-magnetic windings. Every "GRACOIL" is wound to the specified number of uniform turns from precision-gauged wire. Every "GRACOIL" is fully insulated, thoroughly impregnated, and properly laminated when supplied as a complete transformer. The most rigid inspections and tests make sure that each "GRACOIL" is worthy of the name it bears.

If your design calls for a special electro-magnetic application, let competent "GRACOIL" engineers make specific recommendations for you. Write today!

# GRACOIL

"One Good Turn - or a Million"

## THE GRAMER COMPANY

Electrical Coils and Transformers  
2732 N. PULASKI RD., CHICAGO 39, ILL. U. S. A.

for  
COMMUNICATION  
LABORATORY  
AND PRODUCTION  
MAINTENANCE

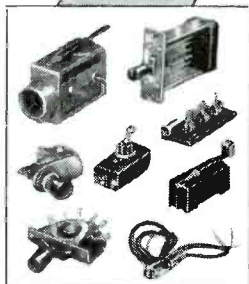

OVER 10,000 electronic items . . . one of the largest stocks in the midwest . . . are available here at W-J for shipment AT ONCE! Maintenance of Industrial Electronic equipment is a highly developed specialty of ours. Users of electronic equipment from coast-to-coast will benefit from *W-J Industrial Emergency Service* . . . countless uses may be found such as those in research laboratories, broadcasting stations, railroad communications systems, airport control towers, shipboard radio installations, to name a few! Our trained procurement experts and technical staffs are geared to function with a speed and efficiency unapproached in the history of Electronic Supplies distribution! Save time and trouble. Make us headquarters for ALL your electronics needs.

★  
SEND FOR THIS NEW BUYERS' GUIDE



## Radio and Electronic Supplies

# WALKER- JIMIESON, INC.

311 SOUTH WESTERN AVE., CHICAGO 12, ILL.

Phone CANal 2525





## PLASTIC BRANDING PLASTIC MOLDING } by **ROGAN**

★ While molding and branding plastics that serve on all battle fronts, Rogan is also preparing for the peace that will follow. Preparing to meet the demand from peacetime industry for the many NEW applications of plastics. And when Peace does come, get Rogan facts on how you can get faster production of plastic parts at less cost.

Write now about your present War plastics and future Peace products.

**ROGAN BROTHERS**  
2007 SOUTH MICHIGAN AVENUE, CHICAGO, ILL.



## Veteran Recorder Shows Its Scars

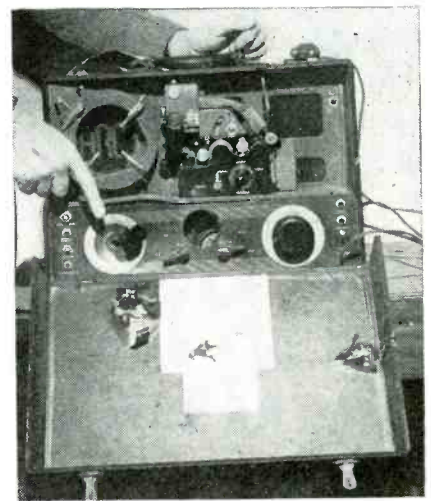

Before winning a mythical Purple Heart for wounds caused by Jap shrapnel, this Recordograph film recorder recently returned to the Marine Corps headquarters in Washington, helped tell the vivid story of the Iwo Jima invasion over the American radio networks and in the newsreels. Loaded on a specially built ammunition cart with batteries and power converter it was taken right up to the front lines. From there the machine went into action recording a complete description of the fighting with a constant background of rocket fire, strafing, mortar bursts, dive bombers and jet propelled planes all around. It recorded the tides of battle from D-Day through D-Day plus five which were later broadcast on the four networks.

## Sealed Terminals

Data and specifications on multiple headers and sealed leads are included in a folder of Electrical Industries, Inc., 42 Summer Ave., Newark 5, N. J. These sealed leads feature low expansion glass chemically bonded to the Kovar metal electrode. Spade end, straight through and hollow vent leads are available as are other styles.

## Magnetic Powders

Table II on page 87 in the August issue of Electronic Industries was incorrectly printed. This table appeared in an article on Magnetic Powders by H. Gregory Shea. The correct table is printed below:

TABLE II

Q of Carbonyl Powders Measured with RMA Coils

Carbonyl Iron Grade	Effective Permeability				
	at 1 kc				
L	4.16				
C	3.65				
E	3.09				
TH	2.97				
SF	2.17				
	Absolute Quality Factor at				
	10 kc	150 kc	200 kc	1 mc	100 mc
78	105	113	113	1	1
73	109	123	189	5	5
63	103	125	255	49	49
63	101	123	263	87	87
48	77	98	221	162	162

## To Our Subscribers:

- When government restrictions have been lifted and heavier paper is available, ELECTRONIC INDUSTRIES will return to the deluxe coated stock and larger size used prewar.

*The Publishers*

## Permanent Magnets

All Shapes, Sizes and Alloys. Alnico magnets cast or sintered under G. E. license. Chrome, Tungsten and Cobalt magnets stamped, formed or cast.

**THOMAS & SKINNER**

STEEL PRODUCTS CO. • INDIANAPOLIS, IND.

**42 YEARS' EXPERIENCE**

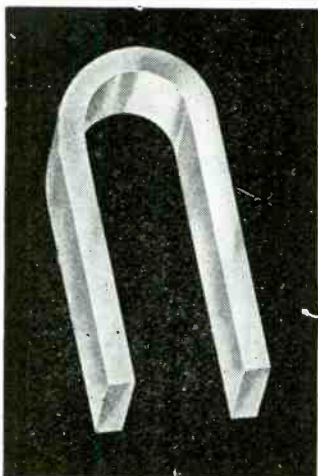

# 1,001 USES

## Condensed Power for Years of Service

VERSATILITY and dependability were paramount when Alliance designed these efficient motors—*Multum in Parvo!* . . . They are ideal for operating fans, movie projectors, light home appliances, toys, switches, motion displays, control systems and many other applications . . . providing economical condensed power for years of service.

### Alliance Precision

Our long established standards of precision manufacturing from highest grade materials are strictly adhered to in these models to insure long life without breakdowns.

#### EFFICIENT

Both the new Model "K" Motor and the Model "MS" are the shaded pole induction type—the last word in efficient small motor design. They can be produced in all standard voltages and frequencies with actual measured power outputs ranging upwards to 1/100 H. P. . . Alliance motors also can be furnished, in quantity, with variations to adapt them to specific applications.

#### DEPENDABLE

Both these models uphold the Alliance reputation for all 'round dependability. In the busy post-war period, there will be many "spots" where these Miniature Power Plants will fit requirements . . . Write now for further information.

Remember Alliance!  
—YOUR ALLY IN WAR AS IN PEACE

**ALLIANCE**  
MANUFACTURING CO.  
ALLIANCE . OHIO

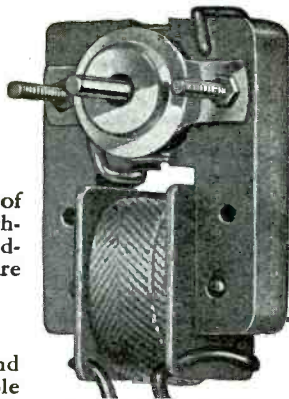

Model "MS"—Full Size  
Motor Measures  
1 3/4" x 2 x 3 1/2"

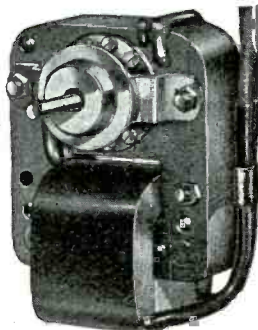

New Model "K"—Full Size  
Motor Measures  
2 1/8" x 2 3/8" x 3 1/4"

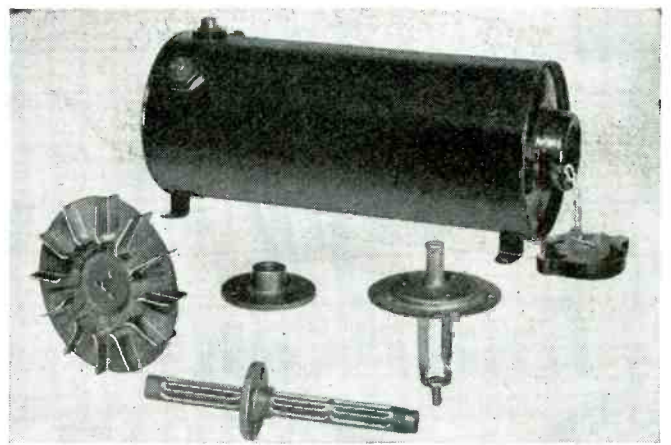

## NEED SHEET METAL ASSEMBLIES?

SIMPLE • INTRICATE • LARGE • SMALL

ALUMINUM  
COPPER • BRASS  
BRONZE • STEEL

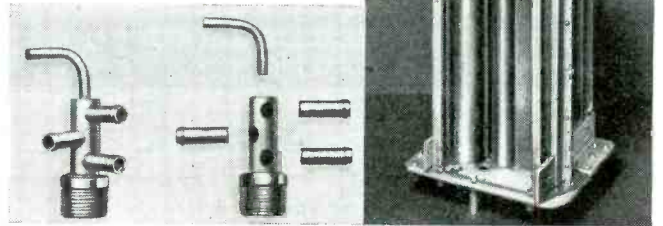

No single factor will have greater influence on post-war products than their parts or assemblies. Speed of production, ingenuity and cost of such parts or assemblies will determine in many cases, the success of the entire product.

Feick experience and facilities for fabricating these assemblies may be of substantial aid in helping your product meet the postwar conditions.

Feick fabricating facilities include joining stampings, forgings, castings or screw machine parts in any combination. Methods involve spot, gas or electric welding and Atmosphere Furnace Brazing. Finishing operations include anodizing, plating and painting (with infra-red drying equipment). Packaging and shipping to customer's order completes these facilities. Capacities range from a few pieces to thousands.

The photos above show a few of the varied assemblies within the range of Feick operations.

To get better jobs, faster, at lower cost, put your parts assembly up to Feick. An experienced fabricating engineer will be glad to discuss your requirements with you. No obligation. Call or write NOW. Feick Manufacturing Co., Div. of Detroit Aircraft Products, Inc., 10240 Meech Ave., Cleveland, Ohio.

**FEICK MANUFACTURING**

DIVISION OF  
DETROIT AIRCRAFT PRODUCTS, INC.  
SPECIALISTS IN THE INTRICATE FORMING, SHAPING AND ASSEMBLY OF ALL METALS

DEPENDABLE



DURABLE  
EFFICIENT

# American Beauty



ELECTRIC  
SOLDERING IRON

TEMPERATURE  
REGULATING STAND

A thermostatically controlled stand for regulating the temperature of an electric soldering iron when at rest. The thermostat is adjustable for various heats.

Preferred by those who measure the value of a tool by the service it renders. Soldering irons are made in 5 sizes and for low as well as standard voltage.

Write for Catalog Sheets.

108-1

AMERICAN ELECTRICAL HEATER COMPANY  
DETROIT 2, MICHIGAN, U. S. A.

FOR CAPACITIES UP TO SEVERAL THOUSAND VOLTS AC, GRAYHILL ROTO-SWITCHES OFFER A NEW VERSATILITY EQUAL TO PRACTICALLY ANY SPECIAL CIRCUIT COMBINATION. SUBMIT YOUR PROBLEM TO OUR ENGINEERING DEPARTMENT.



*Grayhill*

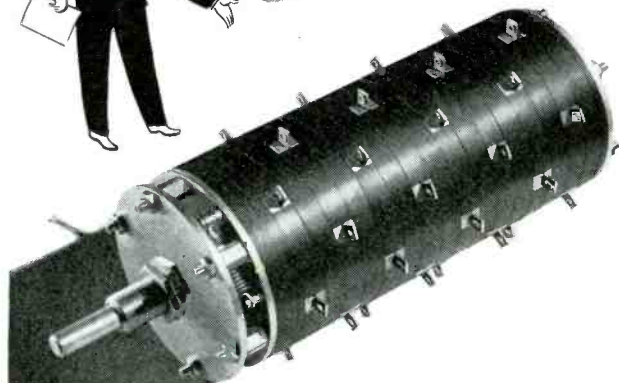

9 North Pulaski Road, Chicago 24, Illinois



**EISLER  
EQUIPMENT**  
... the plus factor  
in tube manufacture



CHAS. EISLER specialized facilities are supplying high-efficiency manual, automatic and semi-automatic machinery for vacuum tube and electronic component production. Hundreds of devices are included — glass tube slicers, stem and sealing machines, flaring units, laboratory apparatus, etc.

(A) No. 161-WH Glass Tube Constriction Forming Machine draws, rapidly, automatically.

(B) No. 16-25 Two-Head Bench Type Flare Machine. Capable of rapid, efficient production. Simple operation.

(C) No. 23-12LD, new type 12 head giant Tipless Stem Machine.

(D) No. 11-TU Glass Tube Slicer, makes clean, sharp cuts—does not require skill.

(E) No. 57-X Laboratory Unit for glass cutting, flaring, stem making, sealing-in, exhausting, basing.

*Chas. Eisler*

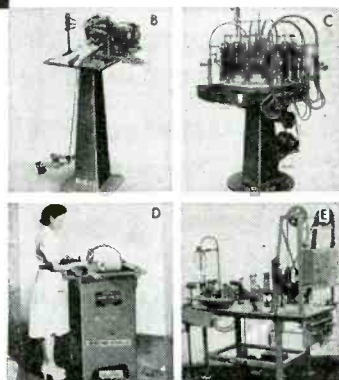

**CHAS. EISLER  
EISLER ENGINEERING CO.**

778 SO. 13th STREET (Near Avon Ave.) NEWARK, NEW JERSEY

## ELECTRICAL ENGINEERS

Post War development. Electronic field. Degree necessary. Familiar with Micro Wave work. Good salary. Finest Lab. equipment and working conditions.

Box 8527

ELECTRONIC INDUSTRIES

480 Lexington Ave.

New York 17, N. Y.

**ESCO**



**SPECIALY  
DESIGNED**

**MOTORS, GENERATORS  
AND OTHER ELECTRICAL POWER UNITS**

Designed and produced to meet your specific requirements . . . not ordinary stock units. From blueprint to finished product . . . our years of engineering skill plus initiative and expert craftsmanship are your assurance of complete satisfaction.

**ELECTRIC SPECIALTY CO.**

214 SOUTH STREET

STAMFORD, CONN.

# PRECISION TIMING

by **ROWE**

**Seconds-Minutes-Hours  
FOR REPEATED "ON-OFF"  
OPERATIONS OR CYCLING OF  
CIRCUITS, USE A ROWE RADIO  
SM4 SYNCHRO-CYCLIC TIMER**

**FAULTLESS AND  
CONTINUOUS OPERATION  
WITHOUT ATTENTION**

**Write, Wire or Phone  
for Bulletin 66-B-45**

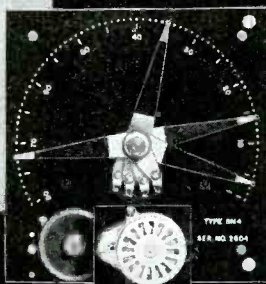

**ROWE RADIO**  
RESEARCH LABORATORY CO.

2422 NORTH PULASKI ROAD • CHICAGO 39, ILLINOIS, U.S.A. • TELEPHONE CAPITOL 3161

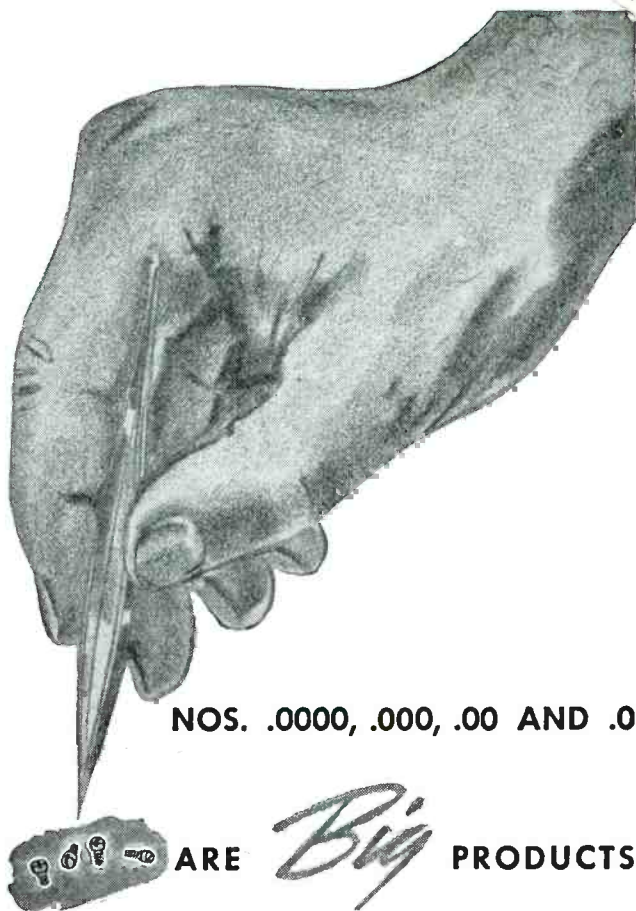

**NOS. .0000, .000, .00 AND .0**

**ARE Big PRODUCTS**

— big in their importance to the manufacture of precision instruments, for they are the *almost infinitesimal* screws that are used in the assemblies of many of the world's finest mechanical masterpieces.

For more than half a century Waltham has specialized in the production of *precision* screws. Its plant and equipment have steadily modernized and expanded to meet the demands of every period of business development and the exacting needs of three wars.

Waltham is tooled to produce fine screw machine products *for a million uses* — any thread, material or finish — any type head, from  $\frac{1}{64}$ " to  $1\frac{1}{2}$ " diameter.

America's Outstanding Producers of Fine Instrument Screws

*Send for catalogue for complete data*

# WALTHAM SCREW

**COMPANY**  
77 Rumford Ave.  
Waltham, Mass.

## RECTIFIER MANUFACTURER NEEDS

### PRODUCTION MANAGER

SELENIUM OR COPPER OXIDE EXPERIENCE

### ELECTRICAL ENGINEER

Technical knowledge of manufacture of selenium or copper oxide rectifiers.

### PRODUCTS ENGINEER

Familiar with industrial applications of selenium rectifiers, manufacturing processes, etc. Old established electrical and electronics manufacturing company located in New York City. Excellent post-war opportunity.

Replies Held Confidential.

Our Employees Know of this Ad.

Box EI 7495, 113 W. 42 St., N. Y. 18.

## SPECIAL BUY!

G.E. • WESTON • WESTERN ELECTRIC

# METERS

They're hard to get—but we got 'em! And we're offering them at this special low price . . . immediately available while they last! **No priorities required!**

### GENERAL ELECTRIC

0-8 RF Amp; Dia.  $2\frac{1}{2}$ "—#279, \$3.25  
0-15 Volt DC; Dia.  $2\frac{1}{2}$ "—#278, \$3.45  
0-500 Mil DC; Dia.  $2\frac{1}{2}$ "—#277, \$3.45  
0-200 Mil DC; Dia.  $2\frac{1}{2}$ "—#276, \$3.45

### WESTERN ELECTRIC

Basic Movement 0-1 Mil DC;  
Scale Marked 0-20 Kilovolt;  
Dia.  $3\frac{3}{4}$ " 1000 ohms per Volt  
—#273, \$4.65

### G.E. • WESTON

0-10 Mil DC; Dia.  $2\frac{1}{2}$ "—  
#274, \$3.25  
0-100 DC; Dia.  $2\frac{1}{2}$ "—  
#275, \$3.45

**RADIONIC EQUIPMENT COMPANY**  
170 NASSAU STREET  
NEW YORK 7, N. Y.

# Toroids..

by

# DX



Doughnut Coils for electronic and telephone purposes. High Permeability Cores are hydrogen annealed and heat treated by a special process developed by DX engineers. Send us your "specs" today—ample production facilities for immediate delivery.

## DX RADIO PRODUCTS CO.

GENERAL OFFICES 1200 N. CLAREMONT AVE., CHICAGO 22, ILL., U.S.A.



# AN 3155 POWER RHEOSTAT

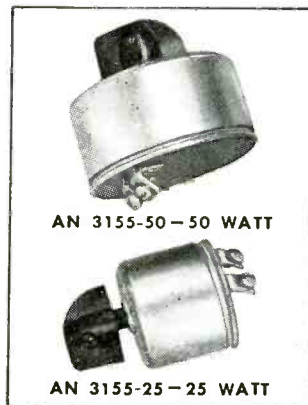

Totally enclosed in accordance with Army-Navy specifications (AN-R-14A).

Permanently sealed in dust-proof, corrosion-proof metal cases.

Smooth control, rugged and thoroughly dependable under the most severe service conditions—shock, vibration, humidity, heat, cold, and altitude.

Hardwick, Hindle is proud of the excellent performance of these power rheostats on thousands of planes flying in every theatre of war under all climatic conditions. And they will prove to be invaluable in innumerable post-war applications.

Let us send you technical data and detailed information on these and many other rheostats and resistors with H-H exclusive features.

Write today for our new catalogue.



**HARDWICK, HINDLE, INC.**

RHEOSTATS and RESISTORS

SUBSIDIARY OF

**THE NATIONAL LOCK WASHER COMPANY**

ESTABLISHED 1886

Newark 5, N. J., U. S. A.

## Instrumentation Conference

At the annual Gibson Island conference on instrumentation methods, sponsored by the American Association for the Advancement of Science, and held at a resort in Chesapeake Bay, 25 miles south of Baltimore, Aug. 13 to 17, the invited group of industrial-application experts was scheduled to hear a program as follows:

Monday: "Analysis of Valve Positioners," E. I. Thomas, Carbide & Carbon Chemicals Corp., South Charleston, W. Va. "Unusual Electronic Applications," Ralph R. Batcher, consulting editor, Electronic Industries.

Tuesday: "Application of Servo-mechanism Theory to Process Control," Dr. A. C. Hall, Massachusetts Institute of Technology, Cambridge, Mass. "Fitting Together Various Control Theories," A. F. Sperry, Hubbard Engineering Co., Chicago.

Wednesday: "Humidity, Its Measurement and Control," Harold W. Crouch, Eastman Kodak Co., Rochester. "Hot-Bulb Hygrometer," Paul W. Keppler, Foxboro Co., Foxboro, Mass. "Newton's Cooling Law Revisited," M. F. Behar, Editor, Instruments, Pittsburgh.

Thursday: "Automatic Control Methods Applied to Basic Flight," O. B. Johnston and R. J. Kutzler, Minneapolis-Hunnewell Co., Minneapolis. "Saturable Reactors and Automatic Control," W. D. Cockrell, General Electric Co., Schenectady. "Spectrophotometry in Process Control," Dr. A. O. Beckman, National Technical Laboratories, South Pasadena, Calif.

Friday: "Petroleum Spectroscopy," S. C. Fulton, Standard Oil Co., Elizabeth, N. J.

## Chatten Joins Philips

Following the resignation of Louis J. Chatten as director of the Radio and Radar Division of WPB, Melvin E. Karns, who has been assistant director in charge of production, has been moved up to occupy the director's chair. Chatten has joined the North American Philips Co. and been made a vice-president and general commercial manager of the company. Taking the place left vacant by Karns, John Creutz has been appointed assistant director for production.

## Bendix Aviation Radar

Bendix Aviation Corp. has permitted it to become known that during the past 19 months certain Navy airplanes have been equipped with a recently perfected ground control approach radar system, which permits safe landings day or night, regardless of weather and under conditions of low visibility. The system is intended to supplement existing instrument landing equipment.



# ELECTRONIC INDUSTRIES

Advertisers - September, 1945

	Page		Page		Page
Accurate Spring Mfg. Co.	135	Eastern Air Devices, Inc.	133	North American Philips Co., Inc.	39
Acme Electric Mfg. Co.	178	Eicor, Inc.	208	Norton Electrical Instrument Co.	244
Adams & Westlake Co.	197	Eisler Engineering Co.	260	Ohmite Mfg. Co.	209
Aerovox Corp.	46	Eitel-McCullough, Inc.	19	Panoramic Radio Corp.	252
Aireon Mfg. Co.	6	Electrical Reactance Corp.	174	Patton-MacGuey Co.	256
Air Reduction	244	Electronic Specialty Co.	260	Permolux Corp.	134
Ajax Electrothermic Corp.	59	Electronic Engineering Co.	249	Pioneer Gen-E-Motor Corp.	174
Albion Coil Co.	152	Electronic Mechanics, Inc.	235	Premax Products	208
Alliance Mfg. Co.	259	Electronic Products Mfg. Corp.	236	Presto Recording Corp.	189
Allied Radio Corp.	146	Electronic Winding Co.	176	Printloid, Inc.	132
Allmetal Screw Products Co.	264	Emerson Radio & Phonograph Corp.	228	Process & Instruments	256
Altec Lansing Corp.	215	Engineering Co.	249	Radell Corp.	230
Amalgamated Radio Television Corp.	222	Erco Radio Laboratories, Inc.	166	Radex Corp.	204
American Condenser Co.	250	Erie Resistor Corp.	9	Radiart Corp.	15
American Gas Accumulator Co.	240	Fast & Co., John E.	32	Radio Corporation of America: RCA Victor Division	49, Cover 4
American Electrical Heater Co.	260	Federal Telephone & Radio Corp.	142, 223	Radicion Equipment Co.	261
American Lava Corp.	239	Feick Mfg. Div. of Detroit Aircraft Products, Inc.	259	Radio Receptor Co., Inc.	31
American Phenolic Corp.	139	Ferris Instrument Co.	48	Radio Wire Television, Inc.	263
American Time Products, Inc.	24	Formica Insulation Co.	157	Rauland Corp.	40, 41
American Transformer Co.	169	Foster Co., A. P.	156	Raytheon Mfg. Co.	68, 141, 256
Amperex Electronic Corp.	2	Freud Radio Corp.	249	R-B-M Mfg. Co.	226
Amperite Co.	255	General Electric Co.	5, 23, 129, 147, 217, 241	Remler Co., Ltd.	140
Anacanda Wire & Cable Co.	161	General Industries Co.	155	Revere Copper & Brass, Inc.	7
Ansonia Electrical Co.	64	General Instrument Corp.	170, 171	Rice's Sons, Inc., Bernard	119
Andrew Co.	202	General Products Div., Automatic Fire Protection Co.	256	Rider Publisher, Inc., John F.	256
Arnold Engineering Co.	164	Goat Metal Stampings, Inc.	248	Ripley Co.	29
Astalc Corp.	192	Gramer Co.	257	Rogan Brothers	258
Automatic Electric Sales Corp.	38	Grayhill	260	Rowe Radio Research Laboratory Co.	261
Barber Laboratories, Alfred W.	232	Green Electric Co., Inc.	172	Runzel Cord & Wire Co.	51
Barker & Williamson	184	Groves Corp.	234	Russell Electric Co.	71, 162
Bell Sound Systems, Inc.	190	Guardian Electric Mfg. Co.	123	Sangamo Electric Co.	66, 67
Bell Telephone Laboratories	36, 37	Hallirrafters Co.	195	Schweitzer Paper Co.	17
Bendix Aviation Corp.: Pacific Div.	243	Hamilton Radio Corp.	252	Scientific Electric, Div. "S" Corrugated Quenched Gap Co.	219
Radio Div.	193	Hammarlund Mfg. Co., Inc.	8	Scovill Mfg. Co.	53
Bentley, Harris Mfg. Co.	47	Hanovia Chemical & Mfg. Co.	178	Screenmakers	230
Benwood-Linze Co.	252, 253	Hardwick, Hindle, Inc.	262	Seeburg Corp., J. P.	22
Biddle Co., James G.	194	Harrison Radio Corp.	248	Selenium Corp. of America	228
Bird & Co., Richard H.	244	Harvey Radio Co.	207	Shellcross Mfg. Co.	198
Boonton Radio Corp.	255	Harvey Radio Laboratories, Inc.	127	Sherron Electronics Co.	25
Bradley Laboratories, Inc.	70	Hassall, Inc., John	242	Shure Brothers	54
Burgess Battery Co.	138	Heinemann Circuit Breaker Co.	33	Sickles Co., F. W.	204
Burke Electric Co.	249	Heintz & Kaufman, Ltd.	42	Simpson Electric Co.	221
Burdyn Engineering Co., Inc.	144	Hexacon Electric Co.	250	Speer Carbon Co.	211
Burstein-Applebee Co.	264	Hickok Electrical Instrument Co.	238	Spencer Wire Co.	185
Byington & Co.	264	Houston Radio Supply Co., Inc.	248	Sperry Gyroscope Co., Inc.	237
Caldwell-Clements, Inc.	175	Hunter Pressed Steel Co.	167	Sneri, Inc.	218
Cambridge Thermionic Corp.	234	Hytron Radio & Electronics Corp.	115	Sprague Electric Co.	20
Cannon Electric Development Co.	190	Indiana Steel Products Co.	26	Stackpole Carbon Co.	50
Capacitron Co.	200	Insuline Corp. of America	196	Standard Transformer Corp.	188
Cardwell Mfg. Corp., Allen D.	206	International Resistance Co.	11	Stewart Stamping Co.	61
Celanese Corp. of America	199	J-B-T Instruments, Inc.	150	Struthers-Dunn, Inc.	187
Centralab	160	Jefferson Electric Co.	27	Stupakoff Ceramic & Mfg. Co.	203
Chicago Telephone Supply Co.	45	Jennings Radio Mfg. Co.	125	Superior Electric Co.	235
Chicago Transformer Div., Essex Wire Corp.	130	Jensen Radio Mfg. Co.	181	Surprenant Electrical Insulation Co.	232
Cincinnati Electric Products Co.	34, 35	Johnson Co., E. F.	137	Sylvania Electric Products, Inc.	148
Clare & Co., C. P.	131	Joliet Chemicals, Ltd.	165	Synthane Corp.	56, 57
Clarostat Mfg. Co., Inc.	166	Jones Co., Howard B.	208	Taylor Fibre Co.	52
Cohn & Co., Sigmund	236	Kahle Engineering Co.	252	Thomas & Skinner Steel Products Co.	258
Cole Steel Equipment Co.	186, 204	Karp Metal Products Co., Inc.	183	Triglett Electrical Instrument Co.	254
Collins Radio Co.	177, 213	Ken-Rad Div. of General Electric Co.	13	Tung-Sol Lamp Works, Inc.	136
Colonial Kolonite Co.	224	Kenyon Transformer Co., Inc.	18	United Catalog Publishers, Inc.	224
Communication Measurements Laboratory	4, 215	Keuffel & Esser Co.	65	United Cinephone Corp.	240
Communications Co., Inc.	154	Kurman Electric Co.	264	United Electronics Co.	179
Conant Electrical Laboratories	196	Langevin Co., Inc.	10	United Screw & Bolt Corp.	62
Concord Radio Corp.	213	Lapp Insulator Co., Inc.	205	United Transformer Corp.	72
Continental Electric Co.	60	Lavoie Laboratories	117	Universal X-Ray Products, Inc.	236
Cook Electric Co.	233	Lectrohm, Inc.	252	Utah Radio Products Co.	153
Cornell-Dubilier Electric Corp.	227	Leland Electric Co.	145	Walker-Jimieson, Inc.	257
Corning Glass Works	247	Lord Mfg. Co.	173	Walsham Screw Co.	261
Cornish Wire Co., Inc.	142	Macallen Co.	182	Ward Leonard Electric Co.	30
Corry-Jamestown Mfg. Corp.	44	Machlett Laboratories, Inc.	55	Ward Products Corp.	242
Coto-Coil Co., Inc.	207	Mallory & Co., Inc., P. R. Cover 2, 12, 28	180	Waterproof Electric Co.	255
Crystal Research Laboratories, Inc.	158	Manross & Sons, F. N.	191	Webster Chicago Corp.	151
Dalis, Inc., H. L.	220	Marion Electrical Instrument Co.	191	Webster Electric Co.	220
Daven Co.	Cover 3	Measurements Corp.	248	Western Electric Co.	36, 37
Delco Radio Div. General Motors	58	Mec-Rad Division-Black Industries	43	Westinghouse Electric Corp.	63, 149
Deutschmann Corp., Tobe	3	Micro Switch Corp.	229	Weston Electrical Instrument Corp.	225
Dial Light Co. of America, Inc.	240	Millen Mfg. Co., Inc., James	224	Whitaker Cable Corp.	69
Doolittle Radio, Inc.	200	Monitor Controller Co.	246	Wiley & Sons, Inc., John	186
Dow Chemical Co.	21	Mycalex Corp. of America	231	Wilson Co., H. A.	201
Drake Mfg. Co.	232	National Co.	16	WiRecorder Corp.	255
Drake Electric Works, Inc.	224	National Research Corp.	168	Wrigley Co., Wm.	228
Dumont Electric Co.	244	New Jersey Jeweler's Supply	182	Zophar Mills, Inc.	158
DuMont Laboratories, Inc., Allen B.	14, 163	New York Transformer Co.	159		
DX Radio Products Co.	262				

**PARTS?**  
ORDER TODAY FROM...

**R. W. T.**  
**WORLD'S LARGEST**  
Radio Supply House • Founded 1922

For Industrial Organizations  
Laboratories • Purchasing Agents  
Radio Dealers & Service Men  
Training Schools • Expeditors  
Amateur Operators and Experimenters

**10,000 PARTS**  
Immediately available. (Some no longer  
need priorities.) Selected and shipped  
same day your order is received.

**Radio Wire  
Television Inc.**  
100 SIXTH AVE. (Dept. N-9) NEW YORK 13  
BOSTON, MASS. NEWARK, N. J.

Originators of the  
**Lafayette Radio**  
soon in production again

# STAINLESS STEEL FASTENING DEVICES

**IN STOCK!**

**Prompt Delivery of both Specials and Standard Items**

- We Stock:**
- Cap Screws
  - Machine Screws
  - Bolts
  - Washers
  - Nuts
  - Wood Screws
  - Taper Pins
  - Pipe Fittings
  - Rivets
  - Cotter Pins
  - Wing Nuts
  - Etc.

When you need non-corrosive fastening devices, write or 'phone Allmetal first. Chances are we have them **IN STOCK** ready for shipment. We can take care of your special work, too, as we have equipment for tapping, drilling, reaming, turning, slotting, etc. We also have complete centerless grinding facilities. Let us estimate on your requirements. Write us today.

**Send for FREE CATALOG**



This new, 83-page catalog helps you pick the correct size and type of non-corrosive fastening device for any particular job. Includes stock sizes, typical specials, engineering data, etc. Make request on company letterhead, please.

Write to  
**DEPARTMENT D**

**ALLMETAL SCREW PRODUCTS CO.**  
80 Grand Street New York 13, N. Y.

## YOUR SOURCE OF SUPPLY FOR MICA AND SEMI-PRECIOUS STONES—POSTWAR

Byington and Company of Brazil control deposits of high grade Brazilian mica and semi-precious stones for postwar development. For further information and particulars contact

### BYINGTON AND COMPANY

(Rio de Janeiro, Sao Paulo, Brazil)

**W. P. BROWN, AGENT**

165 BROADWAY NEW YORK 6, N. Y.

"KURMAN SENSITIVE" OF 1930 - STILL THE BEST

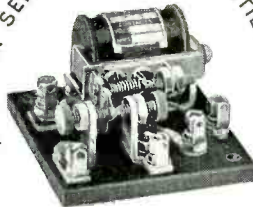

## New Features added to KURMAN RELAYS

MICROPHONE HUMMER TYPE Z-7200



### The Well-Known KURMAN SENSITIVE RELAY

the first to demonstrate the superior magnetic properties of hydrogen-annealed nickel alloy 15 years ago —again introduces an outstanding new feature:—

#### CHATTERLESS OPERATION

— obtained through cushioning of contacts in an energy absorbing material. This feature enables keying up to 150 words p. m. Mica insulation of the armature makes the relay suitable for keying 50 m. c. RF signals.

#### 25 YEARS' EXPERIENCE,

a thoroughly competent staff of Development and Design Engineers, and complete manufacturing facilities are of your service when you submit your Relay problems to us.

Write for details on:

- KURMAN LINE OF RELAYS
- KURMAN VIBRATOR CONVERTERS
- KURMAN MICROPHONE HUMMERS

For trouble-free operation in any climate and at any desired altitude,

#### HERMETICALLY SEALED

relays are available, either of plug-in type or equipped with solder lugs. Some of these relays take as little space as 2" x 1 1/4" dia., and have up to 10 amps current capacity due to the special atmosphere introduced into the container under pressure.

**KURMAN ELECTRIC CO.**



35-18 37th STREET • LONG ISLAND CITY 1, N. Y.

Research design and development engineers for large capacitor plant located in Southeastern Massachusetts. Post-War opportunities for qualified engineers. Write letter giving full details of experience, training, and salary expected.

Applicants will be hired in accordance with the Area Stabilization Plan.

**Box 9595**

**ELECTRONIC INDUSTRIES**

480 LEXINGTON AVENUE NEW YORK 17, N. Y.

## FREE TO YOU COLOR CODE AND OHMS LAW CALCULATOR

A great convenience. Easy to work. Solves many problems. Attach coupon to your letterhead. Free to radio men, engineers, etc.

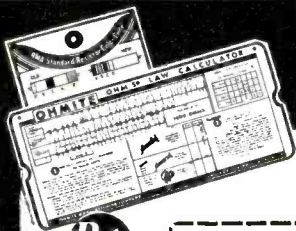

**BURSTEIN-APPLEBEE COMPANY**  
1012 McGee St.  
Kansas City 6, Mo.

Mail Coupon Now

BURSTEIN-APPLEBEE COMPANY  
1012 McGee, Kansas City 6, Mo.  
Send me FREE Color Code and Ohms Law Calculator along with latest catalog.

I am \_\_\_\_\_  
STATE CONNECTION IN INDUSTRY \_\_\_\_\_  
NAME \_\_\_\_\_  
ADDRESS \_\_\_\_\_  
TOWN \_\_\_\_\_ STATE \_\_\_\_\_

## COIL ENGINEER

For R.F. and I.F. coil design. General experience on radio coil requirements essential and also capable of radio and communications development. Permanent opportunity with medium sized, old established Chicago company.

**Box 2**

**ELECTRONIC INDUSTRIES**

201 N. WELLS STREET CHICAGO 6, ILL.



**ATTENUATION BOX**



**DECADE VOLTAGE DIVIDER**



**RATIO ARM BOX**



**TRANSMISSION MEASURING SET**



**OUTPUT METER**



**ELECTRONIC FREQUENCY METER**



**VOLUME LEVEL INDICATOR**



**POWER OUTPUT METER**



**DECADE RESISTANCE BOX**



# DAVEN

## MEASURING, TESTING AND CONTROL EQUIPMENT

These DAVEN instruments are the "trusted aides" of audio communications and general electronic engineers the world over. Each type of equipment is built to the highest standards of precision and durability, and is available in a wide selection of standard models.

Many other test sets and control units, specially designed by DAVEN, are in long service with America's key radio stations, leading sound recording studios, and the Armed Forces.

Full details gladly furnished upon request. Write to . . .  
THE DAVEN COMPANY, 191 Central Ave., Newark 4, N. J.



# THE PRICE OF RCA-833A's HAS BEEN REDUCED 26.5% IN LESS THAN 2 YEARS

Now listed at only \$62.50, this sturdily constructed, long-lasting triode has found many applications in industrial, as well as broadcasting, equipment.



**T**HE 833A is RCA's most powerful glass triode. With forced-air cooling, under CCS ratings, it will take a maximum input of 1250 watts in plate-modulated service, and 1800 watts in oscillator service—at frequencies as high as 20 megacycles.

Under CCS ratings, with natural cooling, the RCA-833A will take a maximum input of 1250 watts at frequencies as high as 30 megacycles.

Among the applications of this tube are:

1. Radio transmitters, both fixed and mobile.
2. Electronic generators for dielectric heating.
3. Electronic generators for induction heating of small metal parts, such as gears.
4. High-power sound systems.
5. Variable-frequency measuring equipment.

## DESIGN FEATURES

**100-Watt Thoriated-Tungsten Filament**—provides a tremendous emission reserve, which protects against unexpected overloads and adds greatly to filament life.

**Giant Zirconium Anode**—provides abundant dissipation for high power-output at frequencies up to 30 megacycles. (Maximum of 400 watts CCS rating, with forced-air cooling.)

**Filament End-Shielding**—special plate construction conserves input power by preventing bulb bombardment.

**Post-Terminal Construction**—Electronic heating, used in making metal-to-glass seals in the 833A, made possible a compact tube that packs high power into a minimum of space. Post terminals extend through bulb to provide support for electrodes. Results in a rugged construction that lends itself to heavy-duty industrial applications.

**Write for Data:** For complete technical data on this tube, write to RCA, Commercial Engineering Department, Section 62-35J, Harrison, N. J.

THE FOUNTAINHEAD OF MODERN TUBE  
DEVELOPMENT IS RCA



62-6136-35



**RADIO CORPORATION  
OF AMERICA**

RCA VICTOR DIVISION • CAMDEN, N. J.